

## High-performance class-G stereo headphone amplifier

Datasheet – production data

### Features

- Power supply range: 2.3 V to 4.8 V
- 0.6 mA/channel quiescent current
- 2.1 mA current consumption with 100  $\mu$ W/channel (10 dB crest factor)
- 0.006% typical THD+N at 1 kHz
- 100 dB typical PSRR at 217 Hz
- 100 dB of SNR A-weighted at G = 0 dB
- Zero "pop and click"
- Gain settings : 0 dB and 6 dB
- Integrated high efficiency step-down converter
- Low standby current: 5  $\mu$ A max
- Output-coupling capacitors removed
- Thermal shutdown
- Flip-chip package: 1.65 mm x 1.65 mm, 400  $\mu$ m pitch, 16 bumps

### Applications

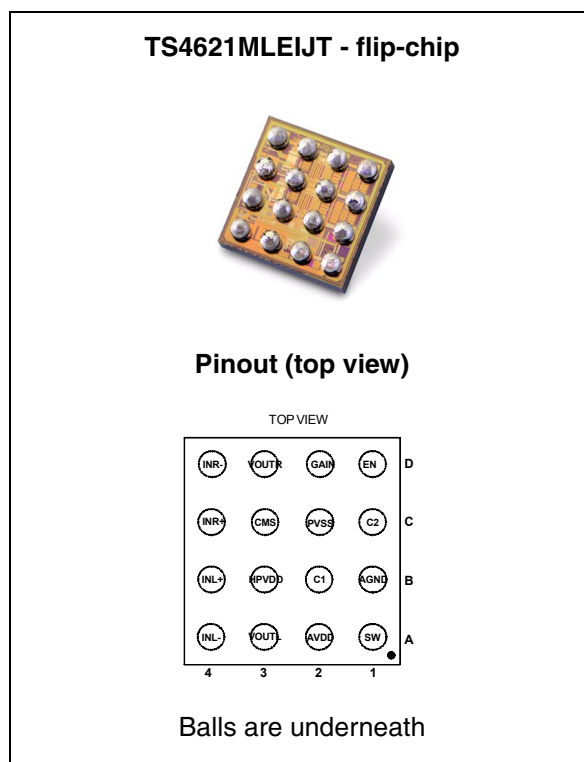
- Cellular phones, smartphones
- Mobile internet devices
- PMP/MP3 players
- Portable CD/DVD players

### Description

The TS4621ML is a class-G stereo headphone driver dedicated to high-performance audio, high-power efficiency and space-constrained applications.

It is based on the core technology of a low power dissipation amplifier combined with a high-efficiency step-down DC/DC converter for supplying this amplifier.

When powered by a battery, the internal step-down DC/DC converter generates the appropriate voltage to the amplifier depending on the



amplitude of the audio signal to supply the headsets. It achieves a total 2.1 mA current consumption at 100  $\mu$ W output power (10 dB crest factor).

THD+N is 0.02 % maximum at 1 kHz and PSRR is 100 dB at 217 Hz, which ensures a high audio quality of the device in a wide range of environments.

The traditionally bulky output coupling capacitors can be removed.

A dedicated common-mode sense pin removes parasitic ground noise.

The TS4621ML is designed to be used with an output serial resistor. It ensures unconditional stability over a wide range of capacitive loads.

The TS4621ML is packaged in a tiny 16-bump flip-chip package with a pitch of 400  $\mu$ m.

# Contents

<b>1</b>	<b>Absolute maximum ratings and operating conditions</b>	<b>5</b>
<b>2</b>	<b>Typical application schematic</b>	<b>7</b>
<b>3</b>	<b>Electrical characteristics</b>	<b>9</b>
<b>4</b>	<b>Application information</b>	<b>25</b>
4.1	Gain control	25
4.2	Overview of the class-G, 2-level headphone amplifier	25
4.3	External component selection	27
4.3.1	Step-down inductor selection (L1)	27
4.3.2	Step-down output capacitor selection ( $C_t$ )	27
4.3.3	Full capacitive inverter capacitors selection ( $C_{12}$ and $C_{SS}$ )	28
4.3.4	Power supply decoupling capacitor selection ( $C_s$ )	28
4.3.5	Input coupling capacitor selection ( $C_{in}$ )	28
4.3.6	Low-pass output filter ( $R_{out}$ and $C_{out}$ ) and IEC 61000-4-2 ESD protection	29
4.3.7	Integrated input low-pass filter	30
4.4	Single-ended input configuration	30
4.4.1	Layout recommendations for single-ended operation	32
4.5	Startup phase	34
4.5.1	Auto zero technology	34
4.5.2	Input impedance	34
4.6	Layout recommendations	34
4.6.1	Common-mode sense layout	35
<b>5</b>	<b>Package information</b>	<b>36</b>
<b>6</b>	<b>Ordering information</b>	<b>38</b>
<b>7</b>	<b>Revision history</b>	<b>39</b>

## List of figures

Figure 1.	Typical application schematic for the TS4621ML	7
Figure 2.	Current consumption vs. power supply voltage	11
Figure 3.	Standby current consumption vs. power supply voltage	11
Figure 4.	Maximum output power vs. power supply voltage, $R_L = 16 \Omega$	11
Figure 5.	Maximum output power vs. power supply voltage, $R_L = 32 \Omega$	11
Figure 6.	Maximum output power vs. power supply voltage, $R_L = 47 \Omega$	11
Figure 7.	Current consumption vs. total output power, $R_L = 16 \Omega$	11
Figure 8.	Current consumption vs. total output power, $R_L = 32 \Omega$	12
Figure 9.	Current consumption vs. total output power, $R_L = 47 \Omega$	12
Figure 10.	Differential input impedance vs. gain	12
Figure 11.	THD+N vs. output power - $R_L = 16 \Omega$ , in-phase, $V_{CC} = 2.5 \text{ V}$	12
Figure 12.	THD+N vs. output power - $R_L = 16 \Omega$ , out-of-phase, $V_{CC} = 2.5 \text{ V}$	12
Figure 13.	THD+N vs. output power - $R_L = 16 \Omega$ , in-phase, $V_{CC} = 3.6 \text{ V}$	12
Figure 14.	THD+N vs. output power - $R_L = 16 \Omega$ , out-of-phase, $V_{CC} = 3.6 \text{ V}$	13
Figure 15.	THD+N vs. output power - $R_L = 16 \Omega$ , in-phase, $V_{CC} = 4.8 \text{ V}$	13
Figure 16.	THD+N vs. output power - $R_L = 16 \Omega$ , out-of-phase, $V_{CC} = 4.8 \text{ V}$	13
Figure 17.	THD+N vs. output power - $R_L = 32 \Omega$ , in-phase, $V_{CC} = 2.5 \text{ V}$	13
Figure 18.	THD+N vs. output power - $R_L = 32 \Omega$ , out-of-phase, $V_{CC} = 2.5 \text{ V}$	14
Figure 19.	THD+N vs. output power - $R_L = 32 \Omega$ , in-phase, $V_{CC} = 3.6 \text{ V}$	14
Figure 20.	THD+N vs. output power - $R_L = 32 \Omega$ , out-of-phase, $V_{CC} = 3.6 \text{ V}$	14
Figure 21.	THD+N vs. output power - $R_L = 32 \Omega$ , in-phase, $V_{CC} = 4.8 \text{ V}$	14
Figure 22.	THD+N vs. output power - $R_L = 32 \Omega$ , out-of-phase, $V_{CC} = 4.8 \text{ V}$	15
Figure 23.	THD+N vs. output power - $R_L = 32 \Omega + \text{IPad}$ , in-phase, $V_{CC} = 2.5 \text{ V}$	15
Figure 24.	THD+N vs. output power - $R_L = 32 \Omega + \text{IPad}$ , out-of-phase, $V_{CC} = 2.5 \text{ V}$	15
Figure 25.	THD+N vs. output power - $R_L = 32 \Omega + \text{IPad}$ , in-phase, $V_{CC} = 3.6 \text{ V}$	15
Figure 26.	THD+N vs. output power - $R_L = 32 \Omega + \text{IPad}$ , out-of-phase, $V_{CC} = 3.6 \text{ V}$	16
Figure 27.	THD+N vs. output power - $R_L = 32 \Omega + \text{IPad}$ , in-phase, $V_{CC} = 4.8 \text{ V}$	16
Figure 28.	THD+N vs. output power - $R_L = 32 \Omega + \text{IPad}$ , out-of-phase, $V_{CC} = 4.8 \text{ V}$	16
Figure 29.	THD+N vs. output power - $R_L = 47 \Omega$ , in-phase, $V_{CC} = 2.5 \text{ V}$	16
Figure 30.	THD+N vs. output power - $R_L = 47 \Omega$ , out-of-phase, $V_{CC} = 2.5 \text{ V}$	17
Figure 31.	THD+N vs. output power - $R_L = 47 \Omega$ , in-phase, $V_{CC} = 3.6 \text{ V}$	17
Figure 32.	THD+N vs. output power - $R_L = 47 \Omega$ , out-of-phase, $V_{CC} = 3.6 \text{ V}$	17
Figure 33.	THD+N vs. output power - $R_L = 47 \Omega$ , in-phase, $V_{CC} = 4.8 \text{ V}$	17
Figure 34.	THD+N vs. output power - $R_L = 47 \Omega$ , out-of-phase, $V_{CC} = 4.8 \text{ V}$	17
Figure 35.	THD+N vs. frequency, $R_L = 16 \Omega$ , in-phase, $V_{CC} = 2.5 \text{ V}$	17
Figure 36.	THD+N vs. frequency, $R_L = 16 \Omega$ , out-of-phase, $V_{CC} = 2.5 \text{ V}$	18
Figure 37.	THD+N vs. frequency, $R_L = 16 \Omega$ , in-phase, $V_{CC} = 3.6 \text{ V}$	18
Figure 38.	THD+N vs. frequency, $R_L = 16 \Omega$ , out-of-phase, $V_{CC} = 3.6 \text{ V}$	18
Figure 39.	THD+N vs. frequency, $R_L = 16 \Omega$ , in-phase, $V_{CC} = 4.8 \text{ V}$	18
Figure 40.	THD+N vs. frequency, $R_L = 16 \Omega$ , out-of-phase, $V_{CC} = 4.8 \text{ V}$	19
Figure 41.	THD+N vs. frequency, $R_L = 32 \Omega$ , in-phase, $V_{CC} = 2.5 \text{ V}$	19
Figure 42.	THD+N vs. frequency, $R_L = 32 \Omega$ , out-of-phase, $V_{CC} = 2.5 \text{ V}$	19
Figure 43.	THD+N vs. frequency, $R_L = 32 \Omega$ , in-phase, $V_{CC} = 3.6 \text{ V}$	19
Figure 44.	THD+N vs. frequency, $R_L = 32 \Omega$ , out-of-phase, $V_{CC} = 3.6 \text{ V}$	20
Figure 45.	THD+N vs. frequency, $R_L = 32 \Omega$ , in-phase, $V_{CC} = 4.8 \text{ V}$	20
Figure 46.	THD+N vs. frequency, $R_L = 32 \Omega$ , out-of-phase, $V_{CC} = 4.8 \text{ V}$	20
Figure 47.	THD+N vs. frequency, $R_L = 47 \Omega$ , in-phase, $V_{CC} = 2.5 \text{ V}$	20
Figure 48.	THD+N vs. frequency, $R_L = 47 \Omega$ , out-of-phase, $V_{CC} = 2.5 \text{ V}$	21

Figure 49.	THD+N vs. frequency, $R_L = 47 \Omega$ , in-phase, $V_{CC} = 3.6 V$ . . . . .	21
Figure 50.	THD+N vs. frequency, $R_L = 47 \Omega$ , out-of-phase, $V_{CC} = 3.6 V$ . . . . .	21
Figure 51.	THD+N vs. frequency, $R_L = 47 \Omega$ , in-phase, $V_{CC} = 4.8 V$ . . . . .	21
Figure 52.	THD+N vs. frequency, $R_L = 47 \Omega$ , out-of-phase, $V_{CC} = 4.8 V$ . . . . .	22
Figure 53.	PSRR vs. frequency - $V_{CC} = 3.6 V$ , gain = 0 dB . . . . .	22
Figure 54.	PSRR vs. frequency - $V_{CC} = 3.6 V$ , gain = +6 dB . . . . .	22
Figure 55.	Output signal spectrum ( $V_{CC} = 3.6 V$ , load = $32 \Omega$ ) . . . . .	22
Figure 56.	Crosstalk vs. frequency - $R_L = 32 \Omega$ , $V_{CC} = 3.6 V$ , gain = 0 dB . . . . .	23
Figure 57.	Crosstalk vs. frequency - $R_L = 32 \Omega$ , $V_{CC} = 3.6 V$ , gain = +6 dB . . . . .	23
Figure 58.	Crosstalk vs. frequency - $R_L = 47 \Omega$ , $V_{CC} = 3.6 V$ , gain = 0 dB . . . . .	23
Figure 59.	Crosstalk vs. frequency - $R_L = 47 \Omega$ , $V_{CC} = 3.6 V$ , gain = +6 dB . . . . .	23
Figure 60.	CMRR vs. frequency, $32 \Omega$ , $V_{CC} = 3.6 V$ , 0 dB . . . . .	24
Figure 61.	CMRR vs. frequency, $32 \Omega$ , $V_{CC} = 3.6 V$ , 6 dB . . . . .	24
Figure 62.	Wake-up time . . . . .	24
Figure 63.	Shutdown . . . . .	24
Figure 64.	TS4621ML architecture . . . . .	25
Figure 65.	Efficiency comparison . . . . .	26
Figure 66.	Class-G operating with a music sample . . . . .	26
Figure 67.	Typical application schematic with IEC 61000-4-2 ESD protection . . . . .	30
Figure 68.	Single-ended input configuration1 . . . . .	31
Figure 69.	Single-ended input configuration 2 . . . . .	31
Figure 70.	Incorrect ground connection for single-ended option . . . . .	32
Figure 71.	Correct ground connection for single-ended option . . . . .	33
Figure 72.	Common-mode sense layout example . . . . .	35
Figure 73.	TS4621ML footprint recommendation . . . . .	36
Figure 74.	Pinout . . . . .	36
Figure 75.	Marking (top view) . . . . .	37
Figure 76.	Flip-chip - 16 bumps . . . . .	37
Figure 77.	Device orientation in tape pocket . . . . .	37

# 1 Absolute maximum ratings and operating conditions

**Table 1. Absolute maximum ratings**

Symbol	Parameter	Value	Unit
$V_{CC}$	Supply voltage <sup>(1)</sup> during 1 ms.	5.5	V
$V_{in+}, V_{in-}$	Input voltage referred to ground	+/- 1.2	V
Control input voltage	EN, Gain	-0.3 to VDD	V
$T_{stg}$	Storage temperature	-65 to +150	°C
$T_j$	Maximum junction temperature <sup>(2)</sup>	150	°C
$R_{thja}$	Thermal resistance junction to ambient <sup>(3)</sup>	200	°C/W
$P_d$	Power dissipation	Internally limited <sup>(4)</sup>	
ESD	Human body model (HBM) <sup>(5)</sup> All pins VOUTr, VOUTL vs. AGND	2 4	kV
	Machine model (MM), min. value <sup>(6)</sup>	100	V
	Charge device model (CDM) All pins VOUTr, VOUTL	500 750	V
	IEC61000-4-2 level 4, contact <sup>(7)</sup> IEC61000-4-2 level 4, air discharge <sup>(7)</sup>	+/- 8 +/- 15	kV
	Lead temperature (soldering, 10 sec)	260	°C

1. All voltage values are measured with respect to the ground pin.
2. Thermal shutdown is activated when maximum junction temperature is reached.
3. The device is protected from overtemperature by a thermal shutdown mechanism, active at 150° C.
4. Exceeding the power derating curves for long periods may provoke abnormal operation.
5. Human body model: a 100 pF capacitor is charged to the specified voltage, then discharged through a 1.5 kΩ resistor between two pins of the device. This is done for all couples of connected pin combinations while the other pins are floating.
6. Machine model: a 200 pF capacitor is charged to the specified voltage, then discharged directly between two pins of the device with no external series resistor (internal resistor < 5 Ω). This is done for all couples of connected pin combinations while the other pins are floating.
7. The measurement is performed on an evaluation board, with ESD protection EMIF02-AV01F3.

**Table 2. Operating conditions**

Symbol	Parameter	Value	Unit
$V_{CC}$	Supply voltage	2.3 to 4.8	V
HPVDD	internal step-down DC output voltages High rail voltage Low rail voltage	1.9 1.2	V
EN,GAIN	Input voltage low level	0.6 V max	V
EN,GAIN	Input voltage high level	1.3 V min	
$R_L$	Load resistor	$\geq 16$	$\Omega$
$C_L$	Load capacitor Serial resistor of 12 $\Omega$ minimum, $R_L \geq 16 \Omega$	0.8 to 100	nF
$T_{oper}$	Operating free air temperature range	-40 to +85	$^{\circ}\text{C}$
$R_{thja}$	Flip-chip thermal resistance junction to ambient	90	$^{\circ}\text{C/W}$

## 2 Typical application schematic

Figure 1. Typical application schematic for the TS4621ML

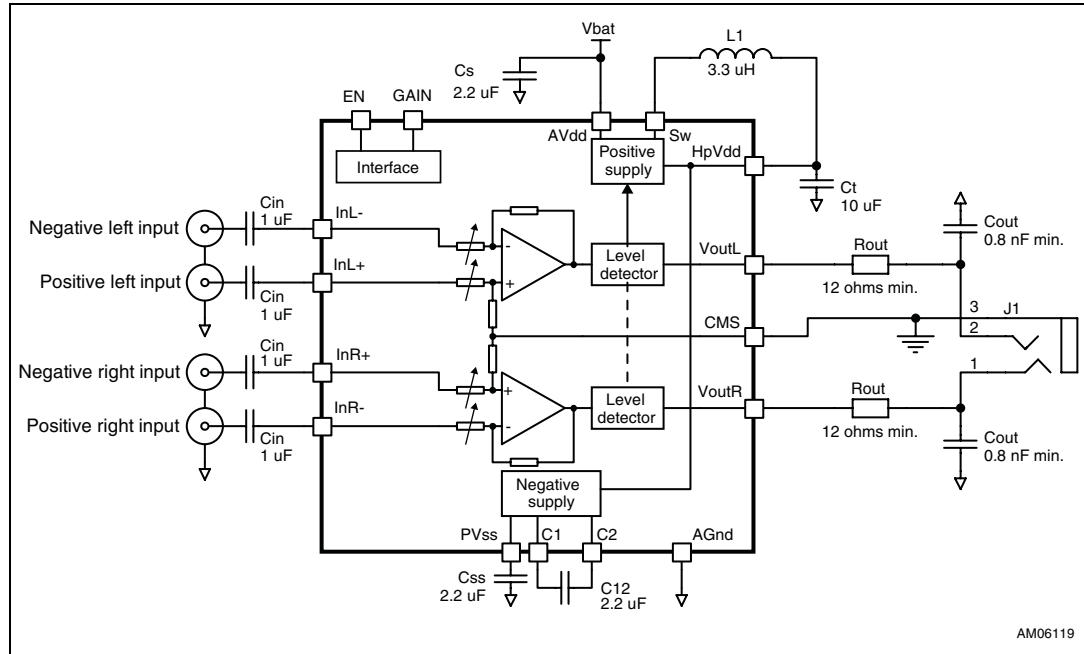


Table 3. TS4621ML pin description

Pin number	Pin name	Pin definition
A1	SW	Switching node of the buck converter
A2	AVDD	Analog supply voltage, connect to battery
A3	VOUTL	Output signal for left audio channel
A4	INL-	Negative input signal for left audio channel
B1	AGND	Device ground
B2	C1	Flying capacitor terminal for internal negative supply generator
B3	HPVDD	Buck converter output, power supply for amplifier
B4	INL+	Positive input signal for left audio channel
C1	C2	Flying capacitor terminal for internal negative supply generator
C2	PVSS	Negative supply generator output
C3	CMS	Common-mode sense, to be connected as close as possible to the ground of headphone/line out plug
C4	INR+	Positive input signal for right audio channel
D1	EN	Amplifier enable
D2	GAIN	Amplifier gain select
D3	VOUTr	Output signal for right audio channel
D4	INR-	Negative input signal for right audio channel

Table 4. TS4621ML component description

Component <sup>(1)</sup>	Value	Description
C <sub>s</sub>	2.2 μF	Decoupling capacitors for V <sub>CC</sub> . A 2.2 μF capacitor is sufficient for proper decoupling of the TS4621ML. An X5R dielectric and 10 V rating voltage is recommended to minimize ΔC/ΔV when V <sub>CC</sub> = 4.8 V. Must be placed as close as possible to the TS4621ML to minimize parasitic inductance and resistance.
C12	2.2 μF	Capacitor for internal negative power supply operation. An X5R dielectric and 6.3 V rating voltage is recommended to minimize ΔC/ΔV when HPVDD = 1.9 V. Must be placed as close as possible to the TS4621ML to minimize parasitic inductance and resistance.
C <sub>SS</sub>	2.2 μF	Filtering capacitor for internal negative power supply. An X5R dielectric and 6.3 V rating voltage is recommended to minimize ΔC/ΔV when HPVDD = 1.9 V.
C <sub>in</sub>	$C_{in} = \frac{1}{2 \times \pi \times R_{in} \times F_c}$	Input coupling capacitor that forms with R <sub>in</sub> ≈ R <sub>indiff</sub> /2 a first-order high-pass filter with a -3 dB cut-off frequency F <sub>c</sub> .
C <sub>out</sub>	0.8 to 100 nF	Output capacitor of 0.8 nF minimum to 100 nF maximum. This capacitor is mandatory for operation of the TS4621ML.
R <sub>out</sub>	12 Ω min.	Output resistor in-series with the TS4621ML output. This 12 Ω minimum resistor is mandatory for operation of the TS4621ML.
L1	3.3 μH	Inductor for internal DC/DC step-down converter. References of inductors: refer to <a href="#">Section 4.3.1</a> for more information.
C <sub>t</sub>	10 μF	Tank capacitor for internal DC/DC step-down converter. An X5R dielectric and 6.3 V rating voltage is recommended to minimize ΔC/ΔV when HPVDD = 1.9 V. Refer to <a href="#">Section 4.3.2</a> for more information.

1. Refer to [Section 4.3](#) for a complete description of each component.



### 3 Electrical characteristics

The values given in the following table are for the conditions  $V_{CC} = +3.6\text{ V}$ ,  $AGND = 0\text{ V}$ ,  $GAIN = 0\text{ dB}$ ,  $R_L = 32\ \Omega + 15\ \Omega$ ,  $T_{amb} = 25^\circ\text{ C}$ , unless otherwise specified.

**Table 5. Electrical characteristics of the amplifier**

Symbol	Parameter	Min.	Typ.	Max.	Unit
$I_{CC}$	Quiescent supply current, no input signal, both channels enabled		1.2	1.5	mA
$I_s$	Supply current, with input modulation, both channels enabled, $HPVDD = 1.2\text{ V}$ , output power per channel, $F = 1\text{ kHz}$ $P_{out} = 100\ \mu\text{W}$ at 3 dB crest factor $P_{out} = 500\ \mu\text{W}$ at 3 dB crest factor $P_{out} = 1\text{ mW}$ at 3 dB crest factor $P_{out} = 100\ \mu\text{W}$ at 10 dB crest factor $P_{out} = 500\ \mu\text{W}$ at 10 dB crest factor $P_{out} = 1\text{ mW}$ at 10 dB crest factor		2.3 3.7 4.7 2.1 3.1 3.9	3.5 5 6.5	mA
$I_{STBY}$	Standby current, no input signal, $V_{EN} = 0\text{ V}$ , $V_{GAIN} = 0\text{ V}$		0.6	5	$\mu\text{A}$
$V_{in}$	Input differential voltage range <sup>(1)</sup>			1	$V_{rms}$
$V_{oo}$	Output offset voltage No input signal	-500		+500	$\mu\text{V}$
$V_{out}$	Maximum output voltage, in-phase signals $R_L = 16\ \Omega$ , THD+N = 1% max, $f = 1\text{ kHz}$ $R_L = 47\ \Omega$ , THD+N = 1% max, $f = 1\text{ kHz}$ $R_L = 10\text{ k}\Omega$ , $R_s = 15\ \Omega$ , $C_L = 1\text{ nF}$ , THD+N = 1% max, $f = 1\text{ kHz}$	0.6 1.0 1.0	0.8 1.1 1.3		$V_{rms}$
THD+N	Total harmonic distortion + noise, $G = 0\text{ dB}$ $V_{out} = 700\text{ mV}_{rms}$ , $F = 1\text{ kHz}$ $V_{out} = 700\text{ mV}_{rms}$ , $20\text{ Hz} < F < 20\text{ kHz}$		0.006 0.05	0.02	%
PSRR	Power supply rejection ratio <sup>(1)</sup> , $V_{ripple} = 200\text{ mV}_{pp}$ , grounded inputs $F = 217\text{ Hz}$ , $G = 0\text{ dB}$ , $R_L \geq 16\ \Omega$ $F = 10\text{ kHz}$ , $G = 0\text{ dB}$ , $R_L \geq 16\ \Omega$	90	100 70		dB
CMRR	Common mode rejection ratio $F = 1\text{ kHz}$ , $G = 0\text{ dB}$ , $V_{ic} = 200\text{ mV}_{pp}$ $F = 20\text{ Hz to } 20\text{ kHz}$ , $G = 0\text{ dB}$ , $V_{ic} = 200\text{ mV}_{pp}$		65 45		dB
Crosstalk	Channel separation $R_L = 32\ \Omega + 15\ \Omega$ , $G = 0\text{ dB}$ , $F = 1\text{ kHz}$ , $P_o = 10\text{ mW}$	60	100		dB
SNR	Signal-to-noise ratio, A-weighted, $V_{out} = 1\text{ V}_{rms}$ , THD+N < 1%, $F = 1\text{ kHz}$ <sup>(1)</sup> $G = +0\text{ dB}$	100			dB
ONoise	Output noise voltage, A-weighted <sup>(1)</sup> $G = +0\text{ dB}$			9	$\mu\text{V}_{rms}$

Table 5. Electrical characteristics of the amplifier (continued)

Symbol	Parameter	Min.	Typ.	Max.	Unit
AV	Closed loop voltage gain, GAIN=L		0		dB
	Closed loop voltage gain, GAIN=H		6		dB
$\Delta AV$	Gain matching between left and right channels	-0.5		+0.5	dB
$R_{indiff}$	Differential input impedance at 6 dB	24	33.2		k $\Omega$
V <sub>IL</sub>	Low level input voltage on EN, GAIN pins			0.6	V
V <sub>IH</sub>	High level input voltage on EN, GAIN pins	1.3			V
I <sub>in</sub>	Input current on EN,GAIN			10	$\mu A$

1. Guaranteed by design and parameter correlation.

Figure 2. Current consumption vs. power supply voltage



Figure 3. Standby current consumption vs. power supply voltage

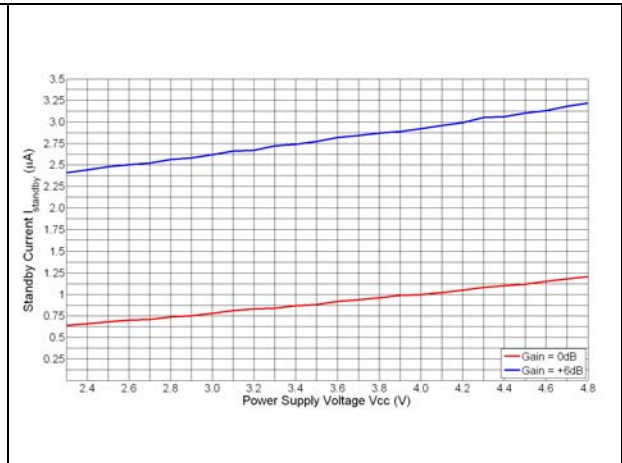


Figure 4. Maximum output power vs. power supply voltage, R<sub>L</sub> = 16 Ω

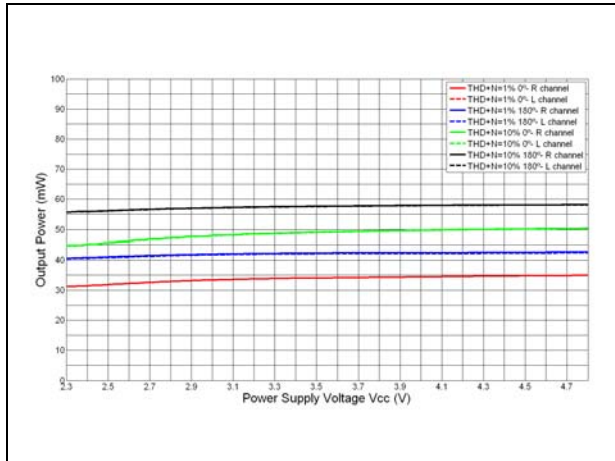


Figure 5. Maximum output power vs. power supply voltage, R<sub>L</sub> = 32 Ω

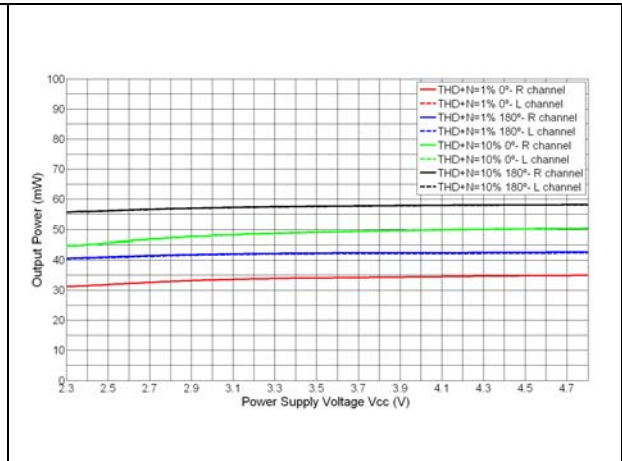


Figure 6. Maximum output power vs. power supply voltage, R<sub>L</sub> = 47 Ω

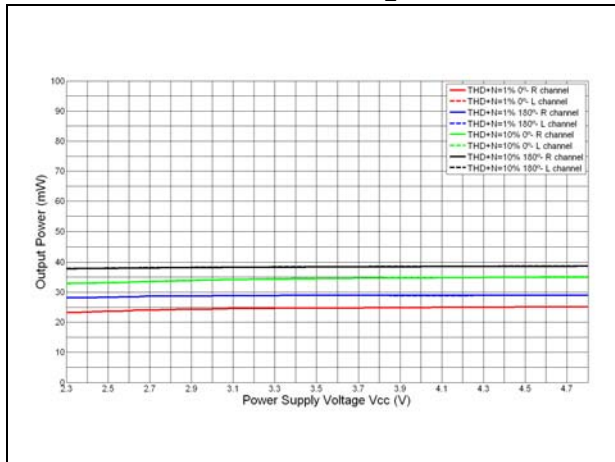


Figure 7. Current consumption vs. total output power, R<sub>L</sub> = 16 Ω

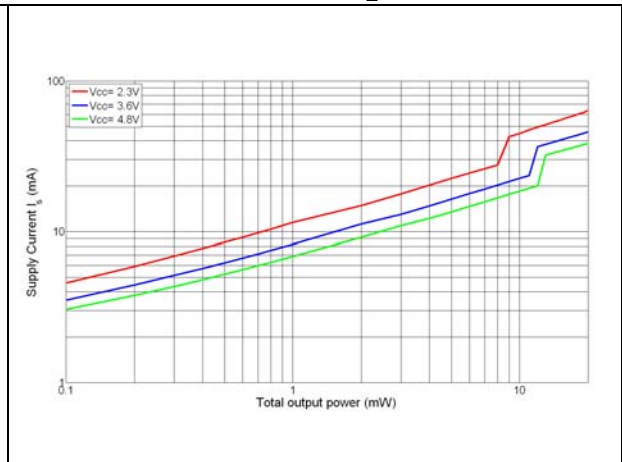


Figure 8. Current consumption vs. total output power,  $R_L = 32 \Omega$

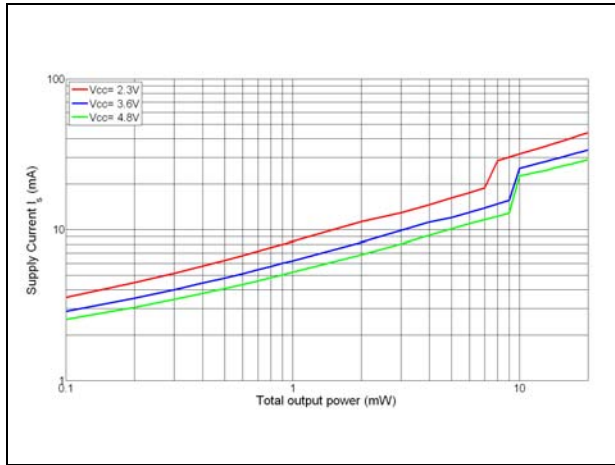


Figure 9. Current consumption vs. total output power,  $R_L = 47 \Omega$

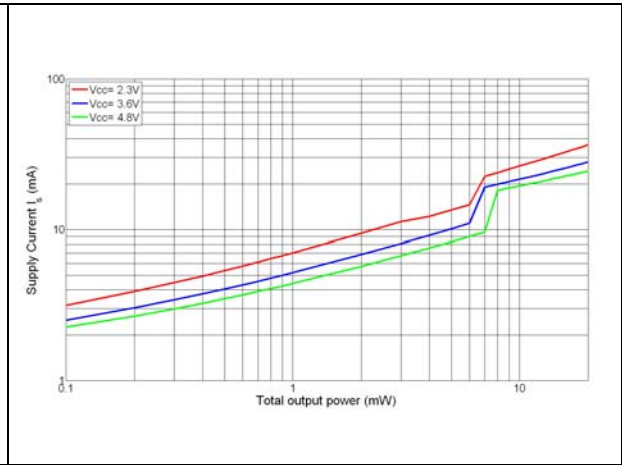


Figure 10. Differential input impedance vs. gain

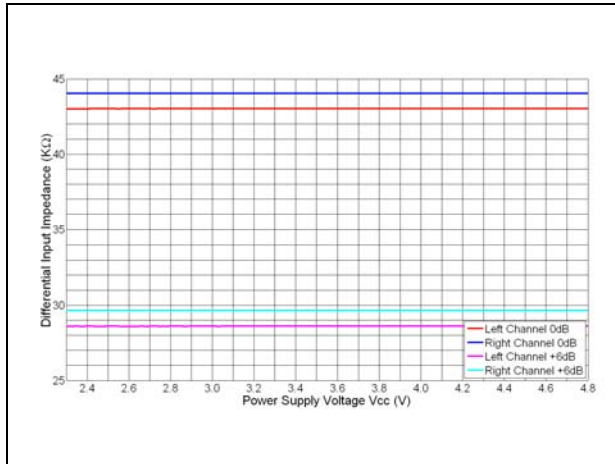


Figure 11. THD+N vs. output power -  $R_L = 16 \Omega$ , in-phase,  $V_{CC} = 2.5 V$

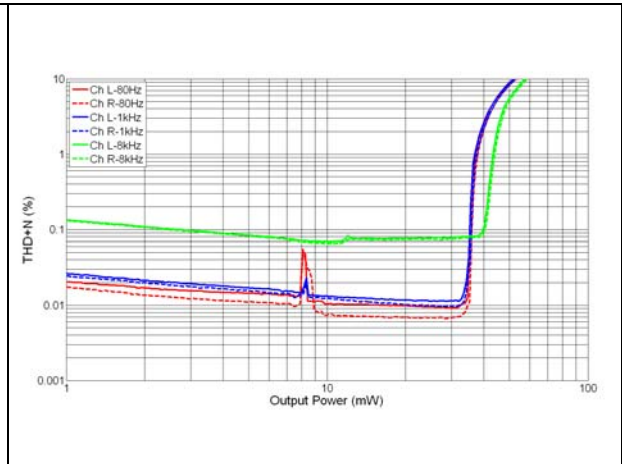


Figure 12. THD+N vs. output power -  $R_L = 16 \Omega$ , out-of-phase,  $V_{CC} = 2.5 V$

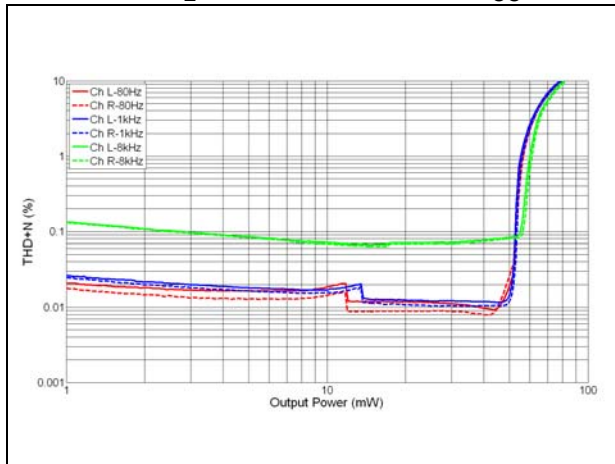


Figure 13. THD+N vs. output power -  $R_L = 16 \Omega$ , in-phase,  $V_{CC} = 3.6 V$

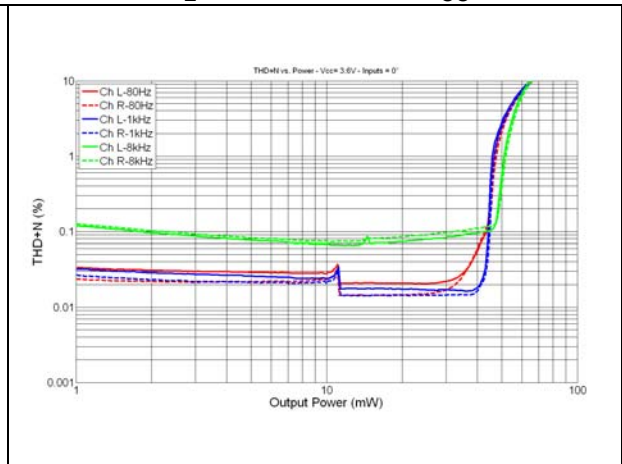


Figure 14. THD+N vs. output power -  $R_L = 16 \Omega$ , out-of-phase,  $V_{CC} = 3.6 V$

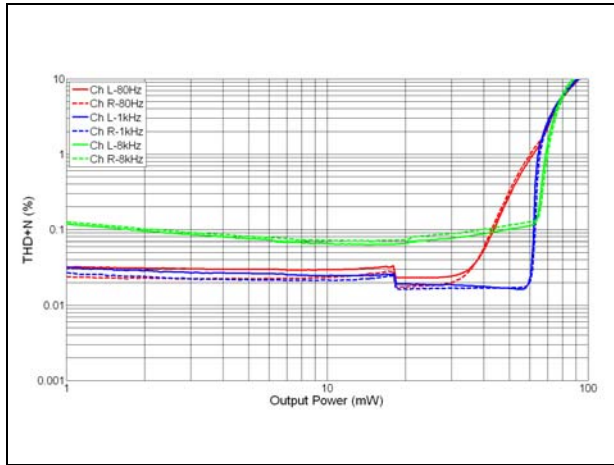


Figure 15. THD+N vs. output power -  $R_L = 16 \Omega$ , in-phase,  $V_{CC} = 4.8 V$

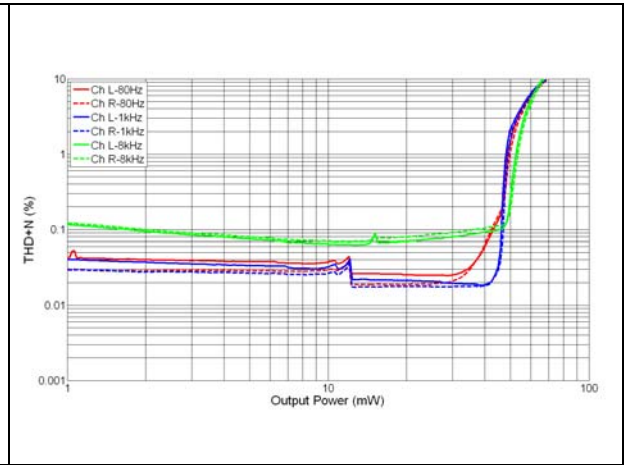


Figure 16. THD+N vs. output power -  $R_L = 16 \Omega$ , out-of-phase,  $V_{CC} = 4.8 V$

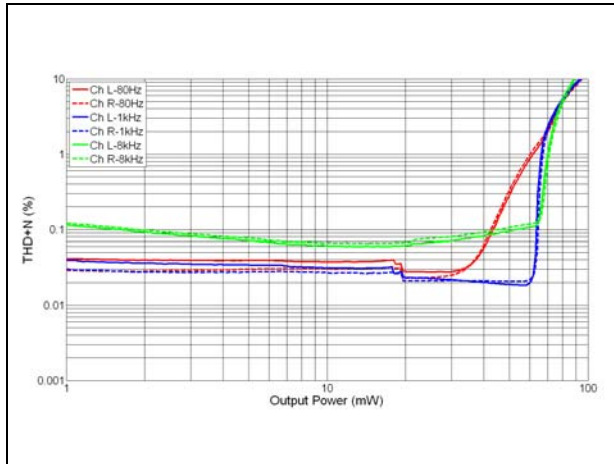


Figure 17. THD+N vs. output power -  $R_L = 32 \Omega$ , in-phase,  $V_{CC} = 2.5 V$

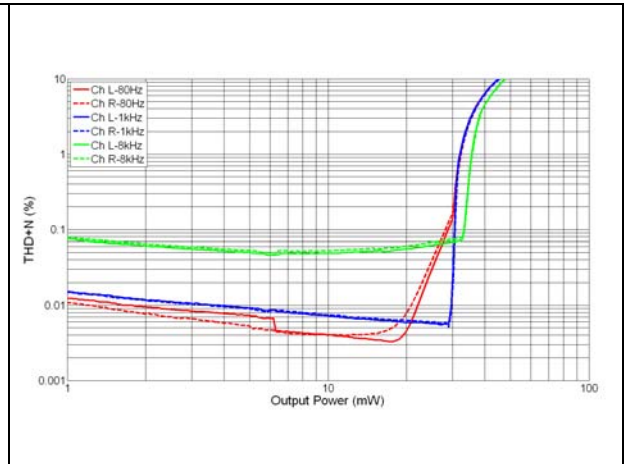


Figure 18. THD+N vs. output power -  $R_L = 32 \Omega$ , out-of-phase,  $V_{CC} = 2.5 V$

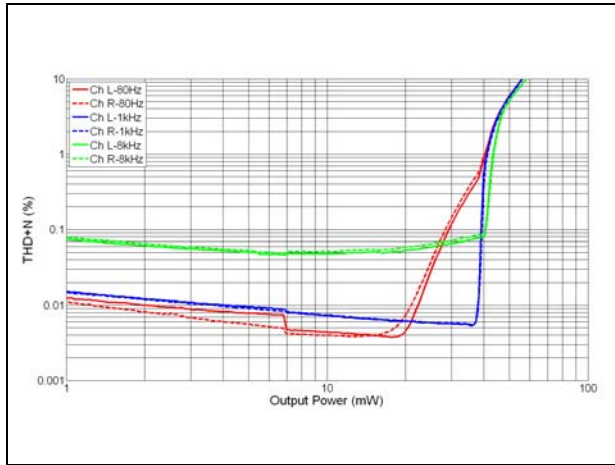


Figure 19. THD+N vs. output power -  $R_L = 32 \Omega$ , in-phase,  $V_{CC} = 3.6 V$

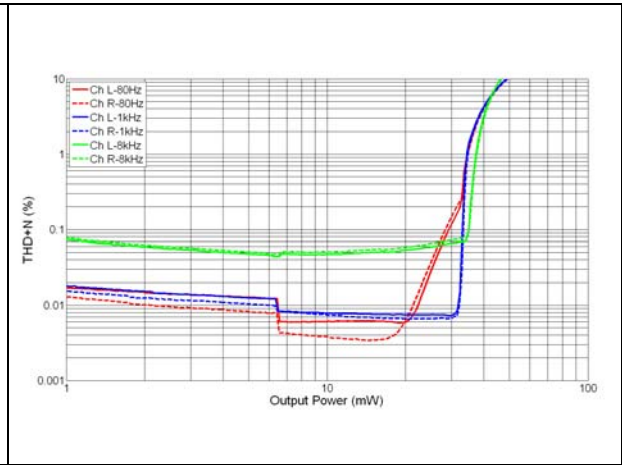


Figure 20. THD+N vs. output power -  $R_L = 32 \Omega$ , out-of-phase,  $V_{CC} = 3.6 V$

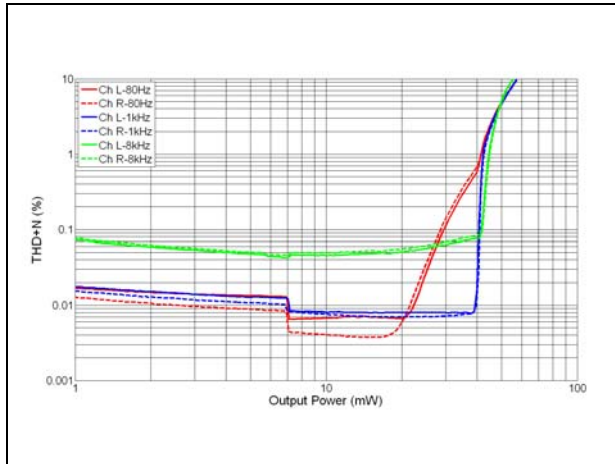
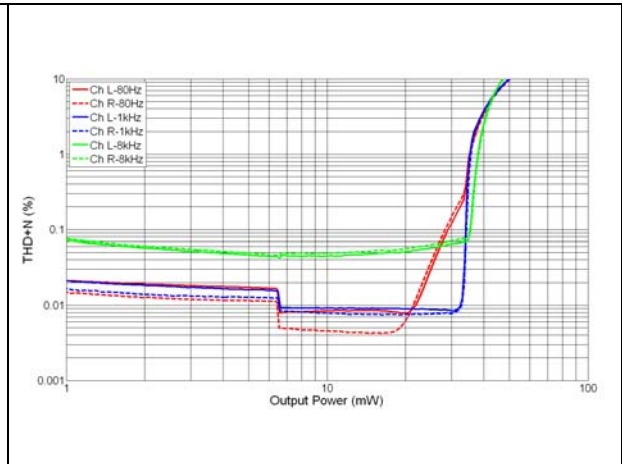
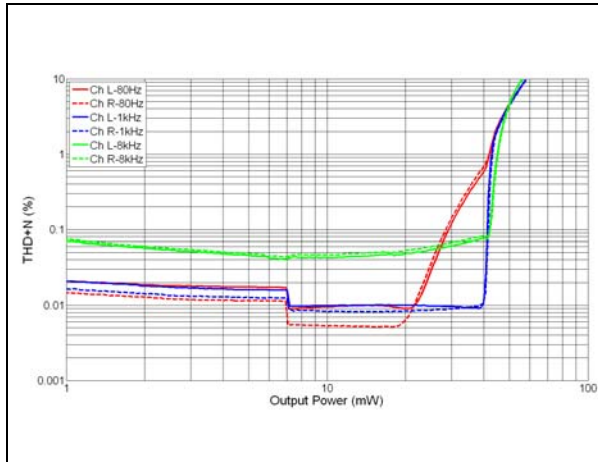


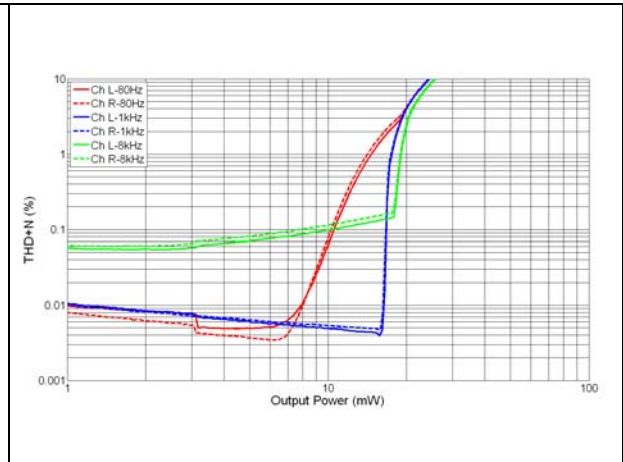
Figure 21. THD+N vs. output power -  $R_L = 32 \Omega$ , in-phase,  $V_{CC} = 4.8 V$



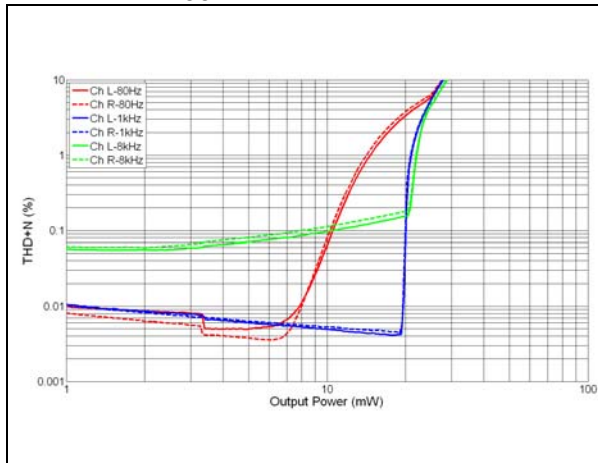
**Figure 22. THD+N vs. output power -  $R_L = 32 \Omega$ , out-of-phase,  $V_{CC} = 4.8 V$**



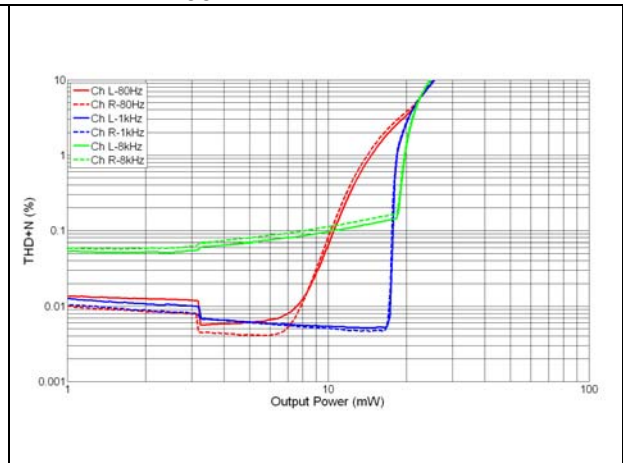
**Figure 23. THD+N vs. output power -  $R_L = 32 \Omega + I_{Pad}$ , in-phase,  $V_{CC} = 2.5 V$**



**Figure 24. THD+N vs. output power -  $R_L = 32 \Omega + I_{Pad}$ , out-of-phase,  $V_{CC} = 2.5 V$**

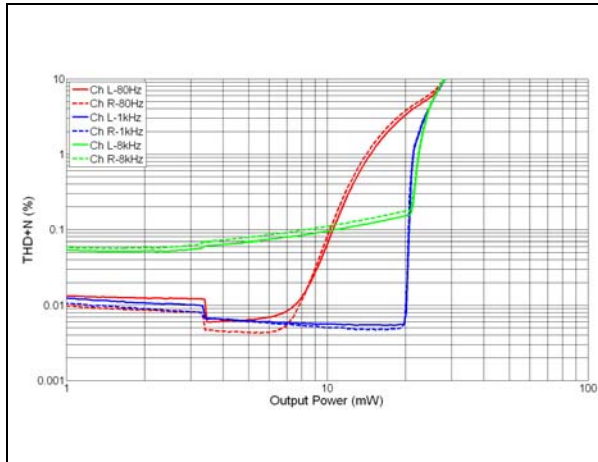


**Figure 25. THD+N vs. output power -  $R_L = 32 \Omega + I_{Pad}$ , in-phase,  $V_{CC} = 3.6 V$**

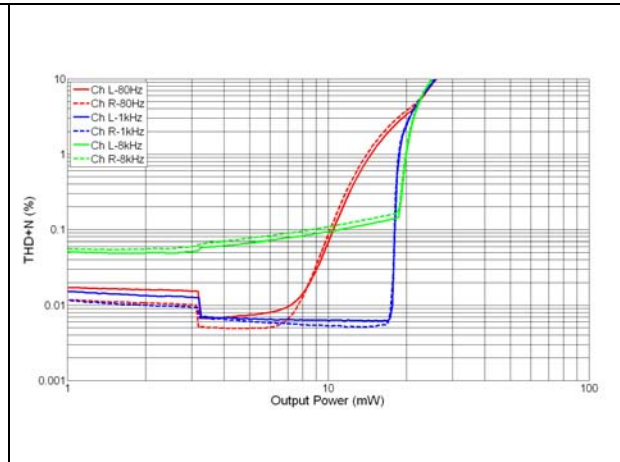




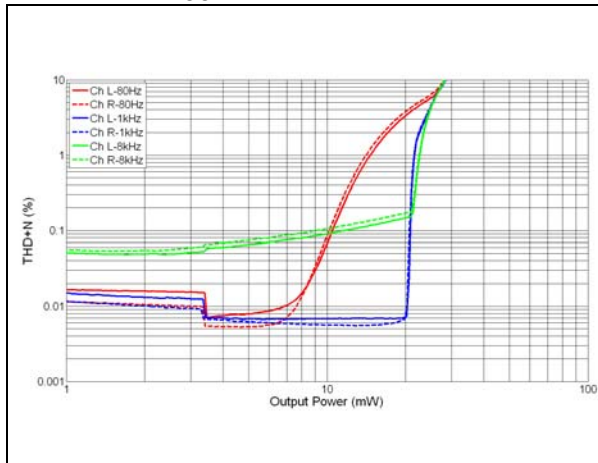
**Figure 26. THD+N vs. output power -  $R_L = 32 \Omega + I_{Pad}$ , out-of-phase,  $V_{CC} = 3.6 V$**



**Figure 27. THD+N vs. output power -  $R_L = 32 \Omega + I_{Pad}$ , in-phase,  $V_{CC} = 4.8 V$**



**Figure 28. THD+N vs. output power -  $R_L = 32 \Omega + I_{Pad}$ , out-of-phase,  $V_{CC} = 4.8 V$**



**Figure 29. THD+N vs. output power -  $R_L = 47 \Omega$ , in-phase,  $V_{CC} = 2.5 V$**

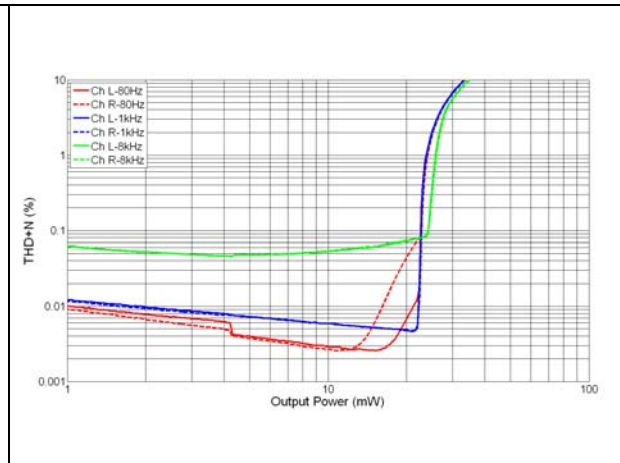




Figure 30. THD+N vs. output power -  $R_L = 47 \Omega$ , out-of-phase,  $V_{CC} = 2.5 V$

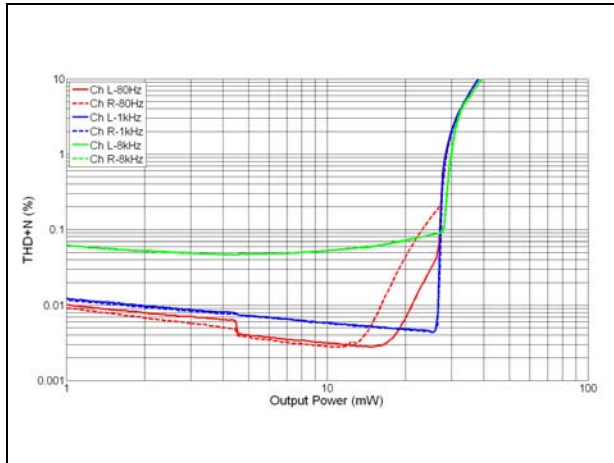


Figure 31. THD+N vs. output power -  $R_L = 47 \Omega$ , in-phase,  $V_{CC} = 3.6 V$

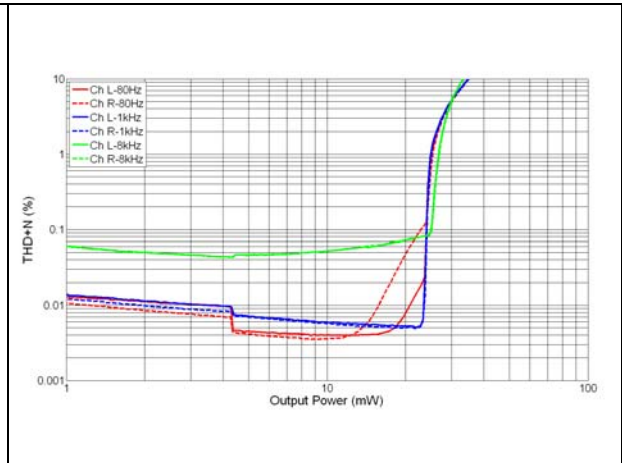


Figure 32. THD+N vs. output power -  $R_L = 47 \Omega$ , out-of-phase,  $V_{CC} = 3.6 V$

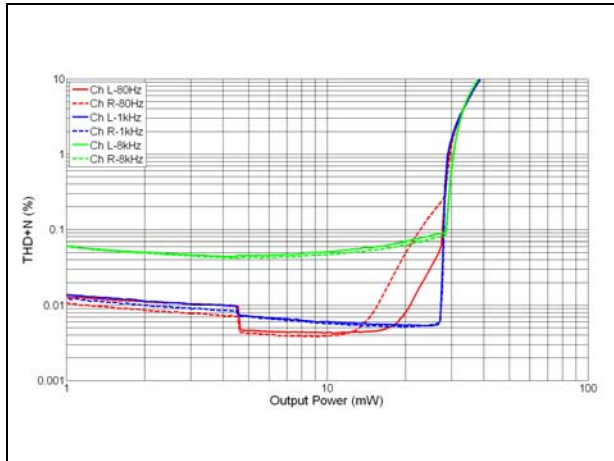


Figure 33. THD+N vs. output power -  $R_L = 47 \Omega$ , in-phase,  $V_{CC} = 4.8 V$

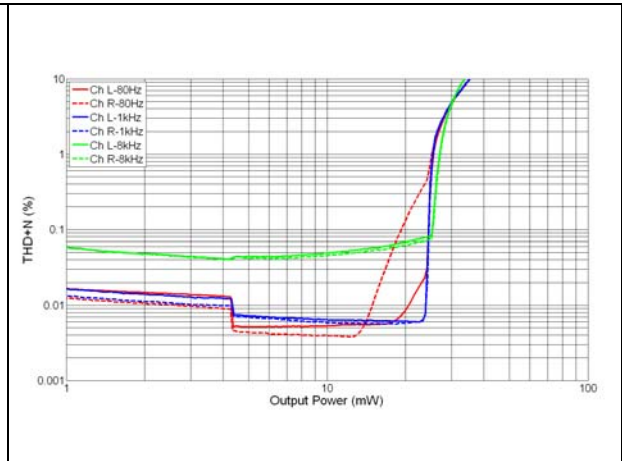


Figure 34. THD+N vs. output power -  $R_L = 47 \Omega$ , out-of-phase,  $V_{CC} = 4.8 V$

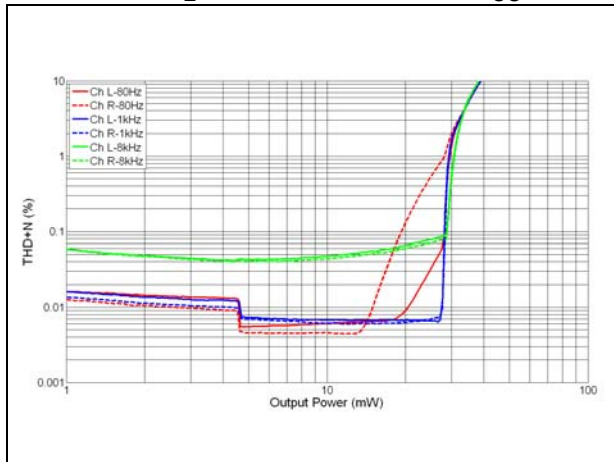


Figure 35. THD+N vs. frequency,  $R_L = 16 \Omega$ , in-phase,  $V_{CC} = 2.5 V$

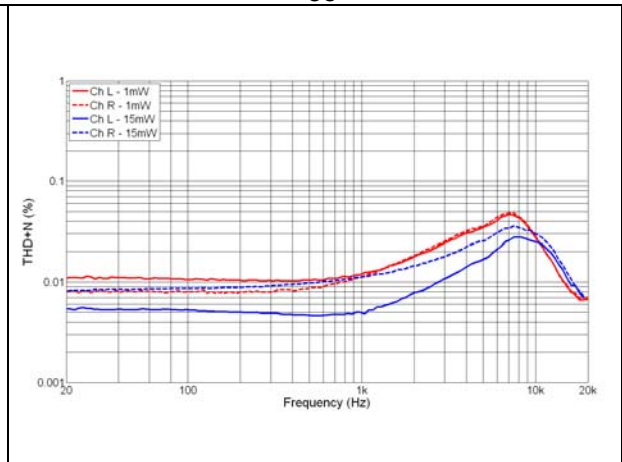


Figure 36. THD+N vs. frequency,  $R_L = 16 \Omega$ , out-of-phase,  $V_{CC} = 2.5 V$

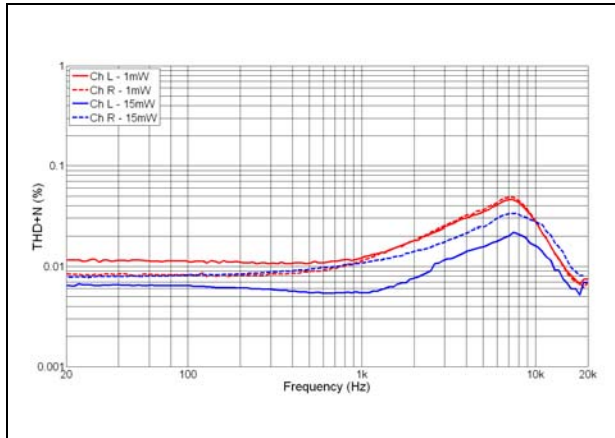


Figure 37. THD+N vs. frequency,  $R_L = 16 \Omega$ , in-phase,  $V_{CC} = 3.6 V$

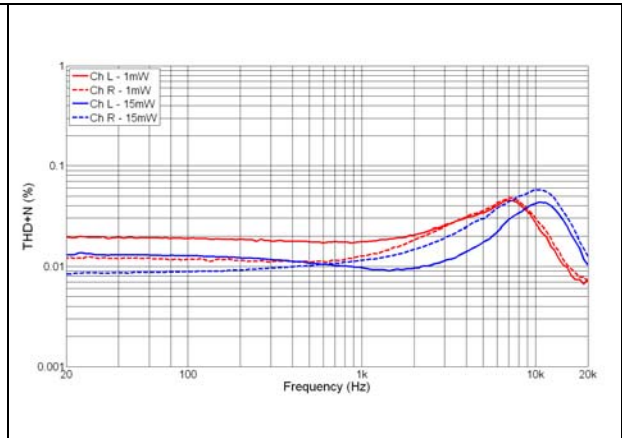


Figure 38. THD+N vs. frequency,  $R_L = 16 \Omega$ , out-of-phase,  $V_{CC} = 3.6 V$

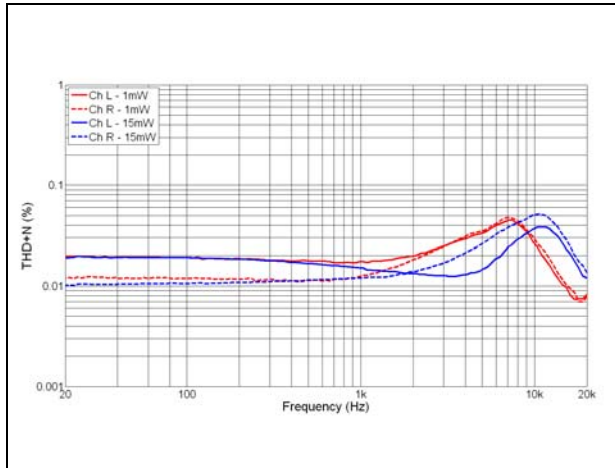


Figure 39. THD+N vs. frequency,  $R_L = 16 \Omega$ , in-phase,  $V_{CC} = 4.8 V$

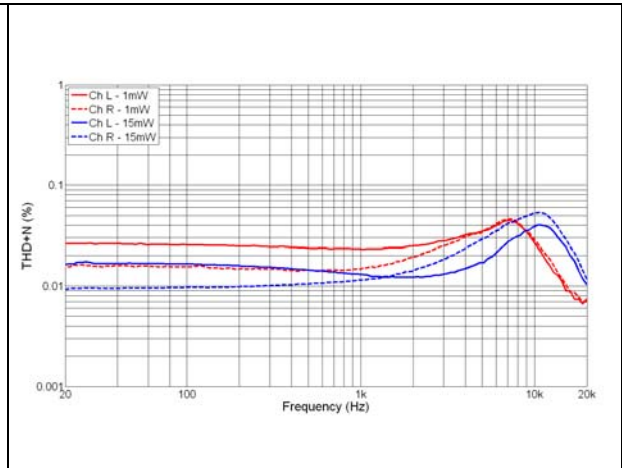


Figure 40. THD+N vs. frequency,  $R_L = 16 \Omega$ , out-of-phase,  $V_{CC} = 4.8 V$

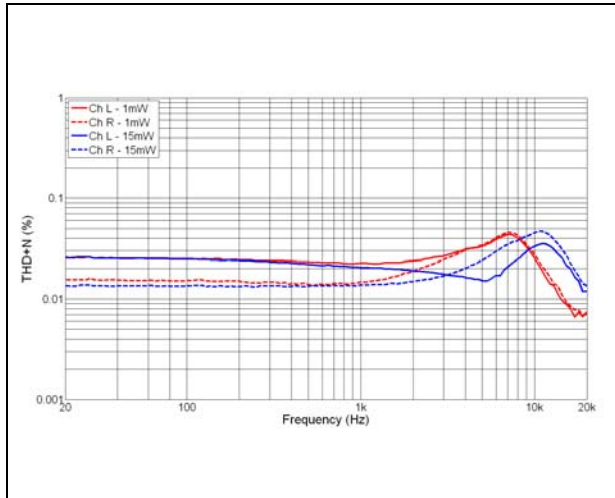


Figure 41. THD+N vs. frequency,  $R_L = 32 \Omega$ , in-phase,  $V_{CC} = 2.5 V$

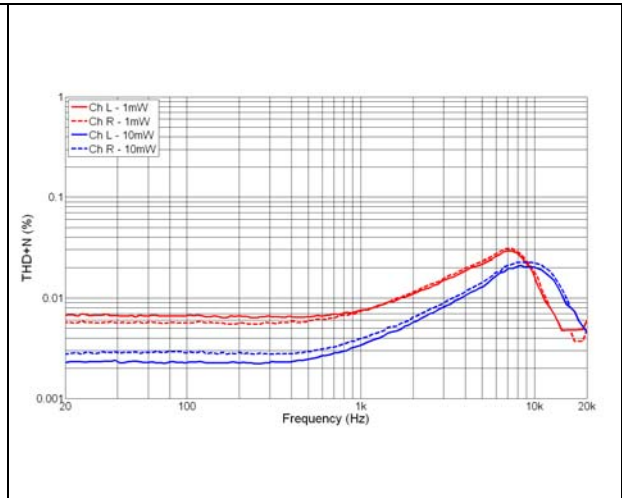


Figure 42. THD+N vs. frequency,  $R_L = 32 \Omega$ , out-of-phase,  $V_{CC} = 2.5 V$

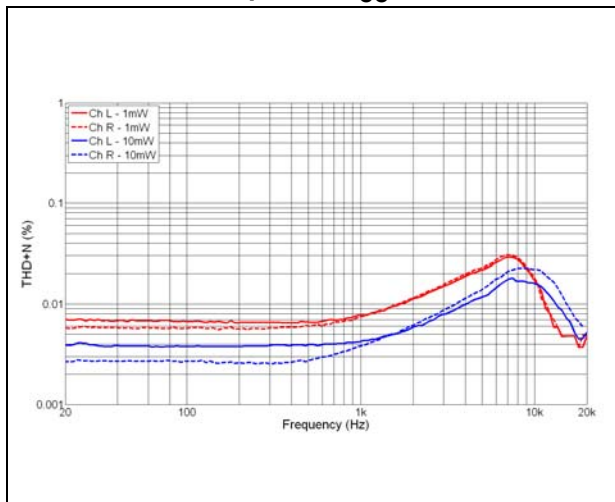


Figure 43. THD+N vs. frequency,  $R_L = 32 \Omega$ , in-phase,  $V_{CC} = 3.6 V$

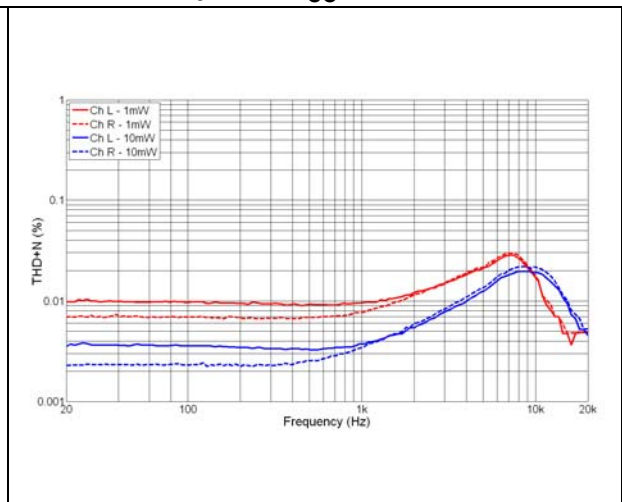


Figure 44. THD+N vs. frequency,  $R_L = 32 \Omega$ , out-of-phase,  $V_{CC} = 3.6 V$

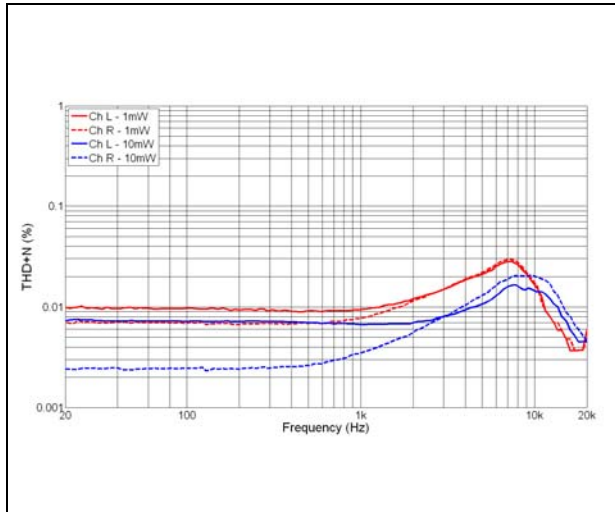


Figure 45. THD+N vs. frequency,  $R_L = 32 \Omega$ , in-phase,  $V_{CC} = 4.8 V$

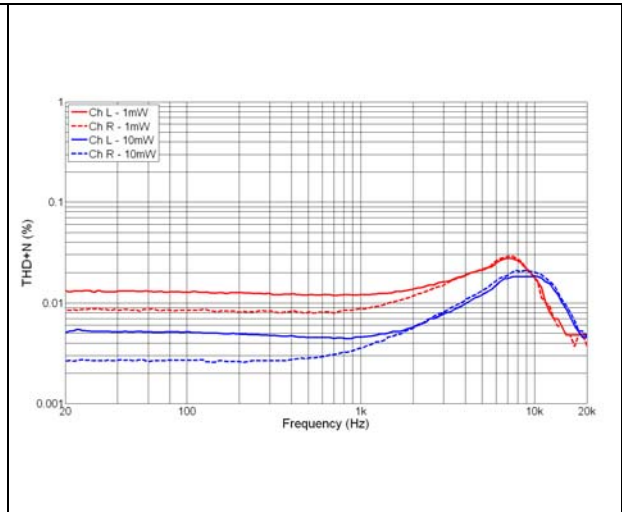


Figure 46. THD+N vs. frequency,  $R_L = 32 \Omega$ , out-of-phase,  $V_{CC} = 4.8 V$

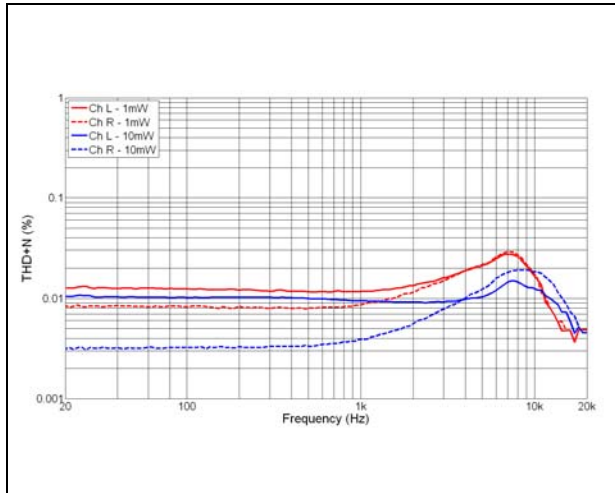


Figure 47. THD+N vs. frequency,  $R_L = 47 \Omega$ , in-phase,  $V_{CC} = 2.5 V$

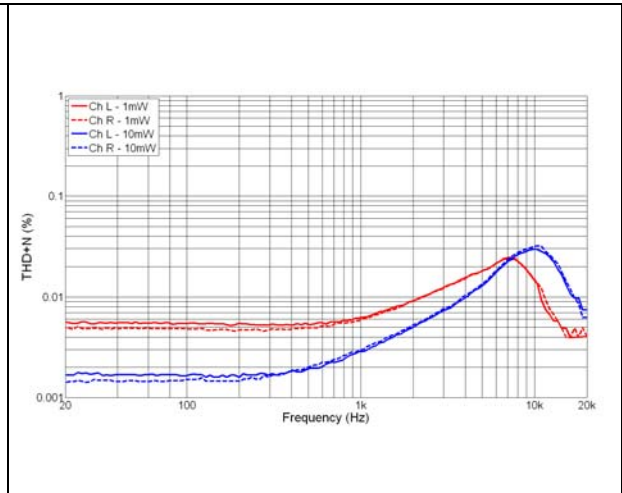


Figure 48. THD+N vs. frequency,  $R_L = 47 \Omega$ , out-of-phase,  $V_{CC} = 2.5 V$

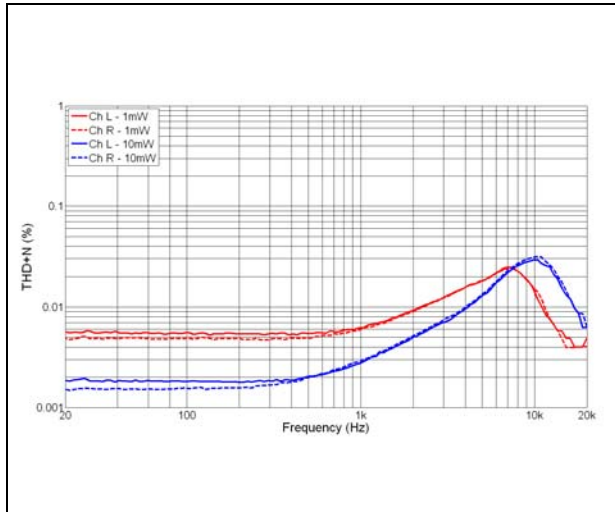


Figure 49. THD+N vs. frequency,  $R_L = 47 \Omega$ , in-phase,  $V_{CC} = 3.6 V$

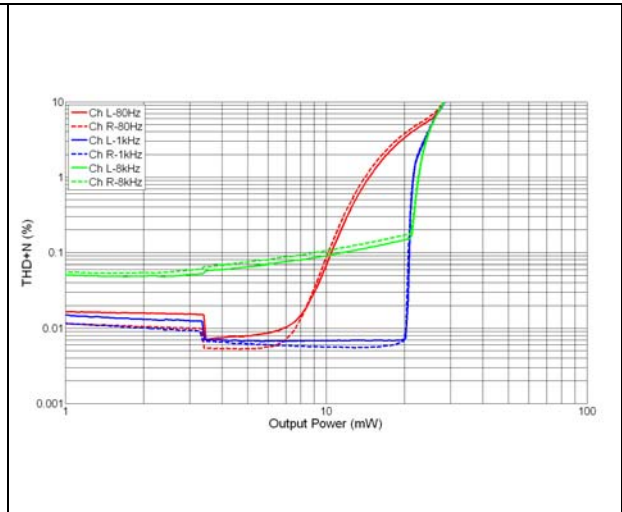


Figure 50. THD+N vs. frequency,  $R_L = 47 \Omega$ , out-of-phase,  $V_{CC} = 3.6 V$

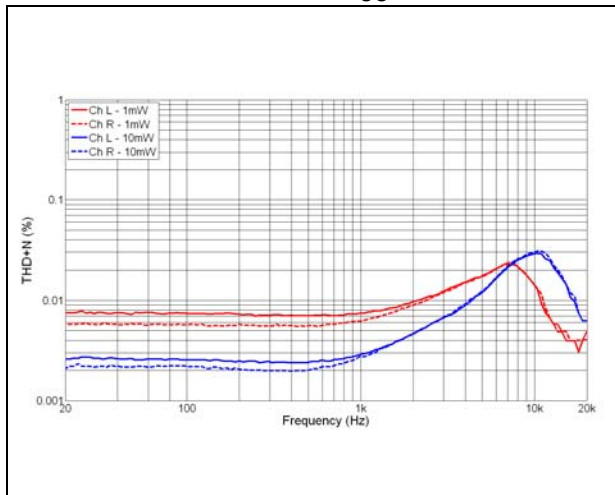


Figure 51. THD+N vs. frequency,  $R_L = 47 \Omega$ , in-phase,  $V_{CC} = 4.8 V$

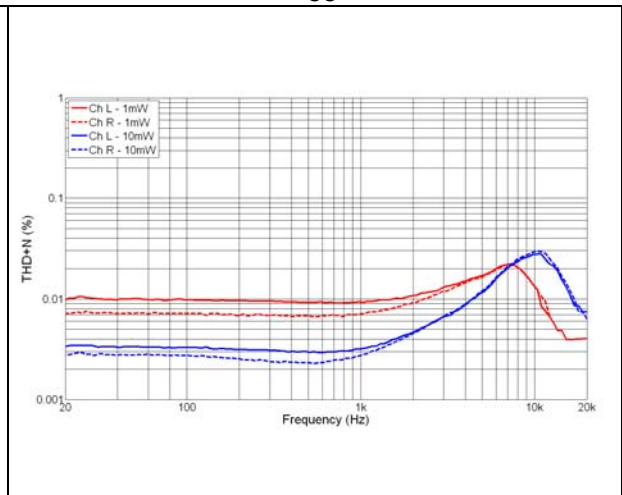


Figure 52. THD+N vs. frequency,  $R_L = 47 \Omega$ , out-of-phase,  $V_{CC} = 4.8 V$

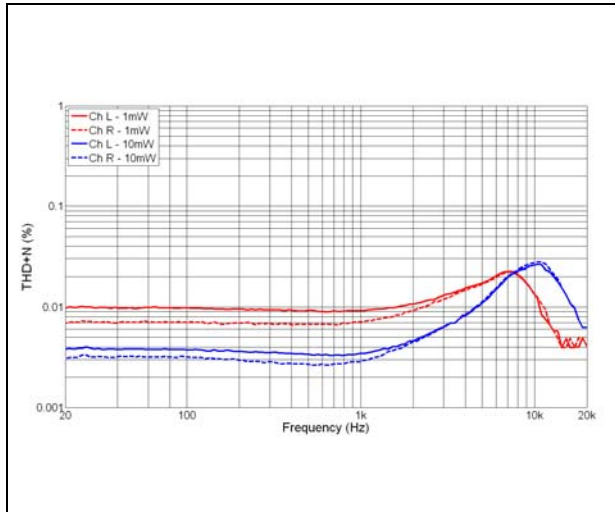


Figure 53. PSRR vs. frequency -  $V_{CC} = 3.6 V$ , gain = 0 dB

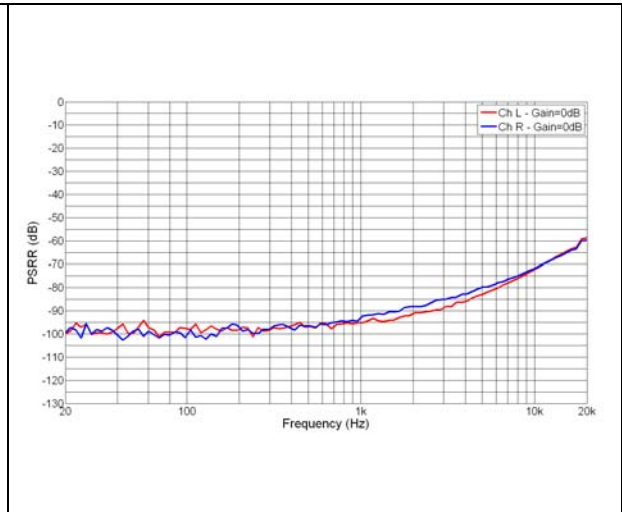


Figure 54. PSRR vs. frequency -  $V_{CC} = 3.6 V$ , gain = +6 dB

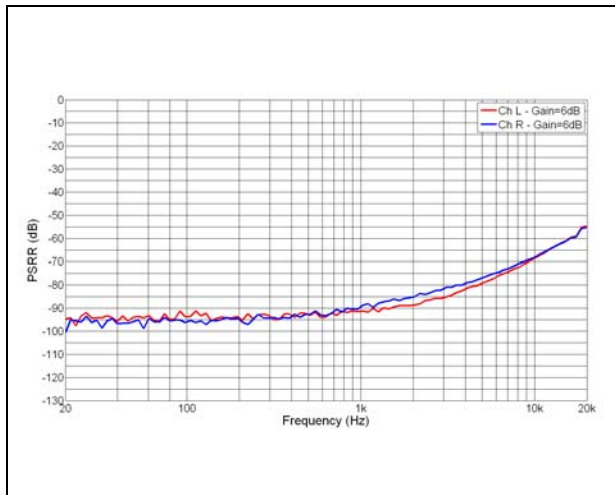
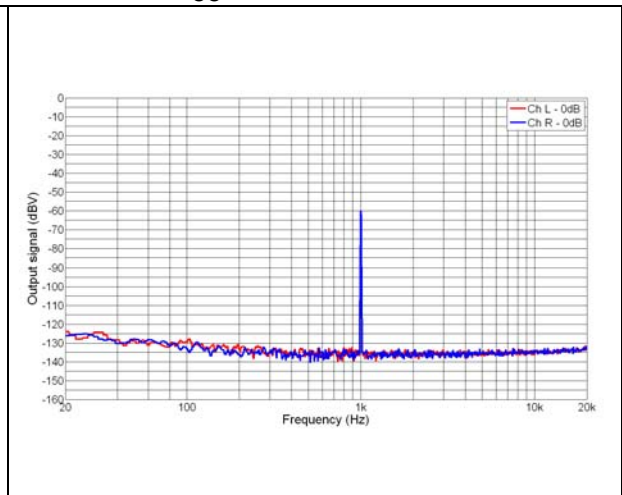
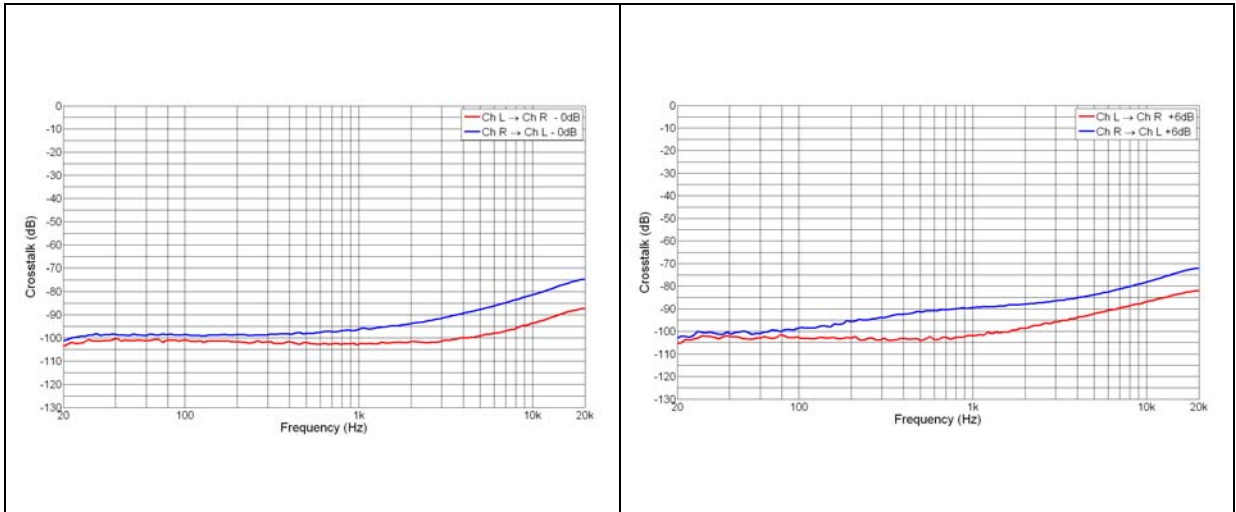


Figure 55. Output signal spectrum ( $V_{CC} = 3.6 V$ , load =  $32 \Omega$ )

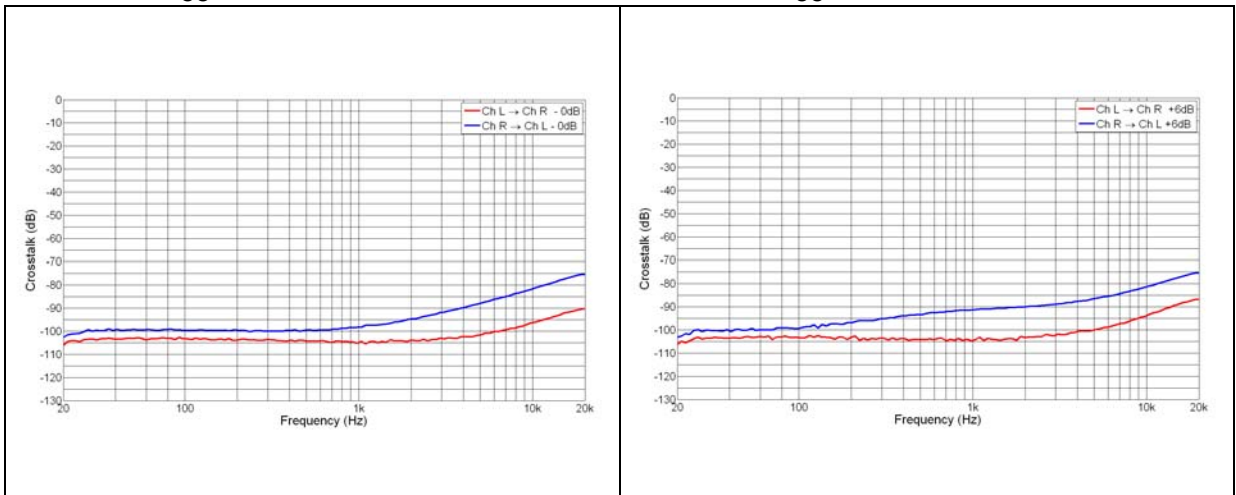




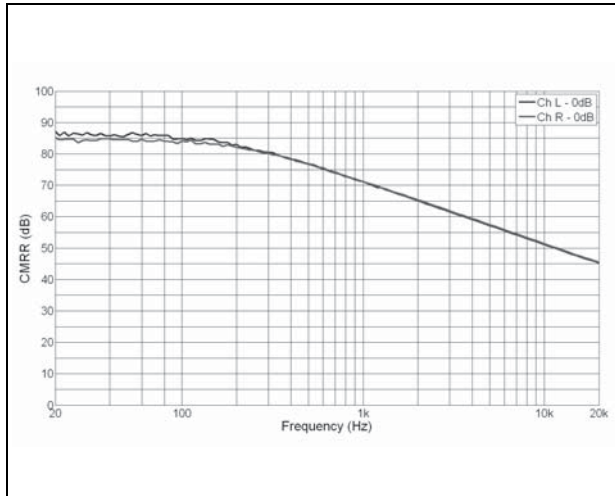
**Figure 56. Crosstalk vs. frequency -  $R_L = 32 \Omega$ ,  $V_{CC} = 3.6 V$ , gain = 0 dB**      **Figure 57. Crosstalk vs. frequency -  $R_L = 32 \Omega$ ,  $V_{CC} = 3.6 V$ , gain = +6 dB**



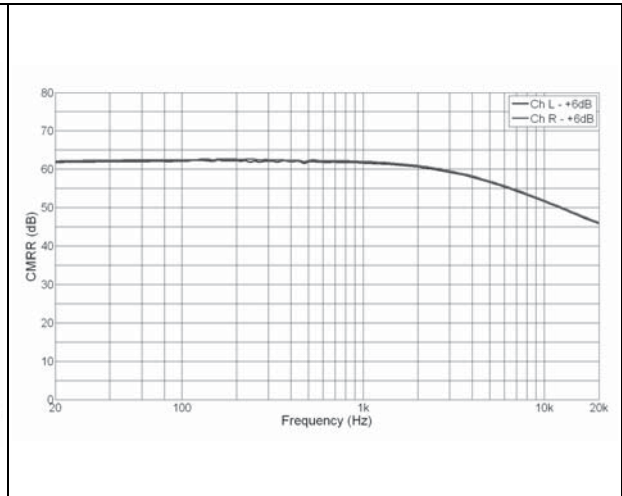
**Figure 58. Crosstalk vs. frequency -  $R_L = 47 \Omega$ ,  $V_{CC} = 3.6 V$ , gain = 0 dB**      **Figure 59. Crosstalk vs. frequency -  $R_L = 47 \Omega$ ,  $V_{CC} = 3.6 V$ , gain = +6 dB**



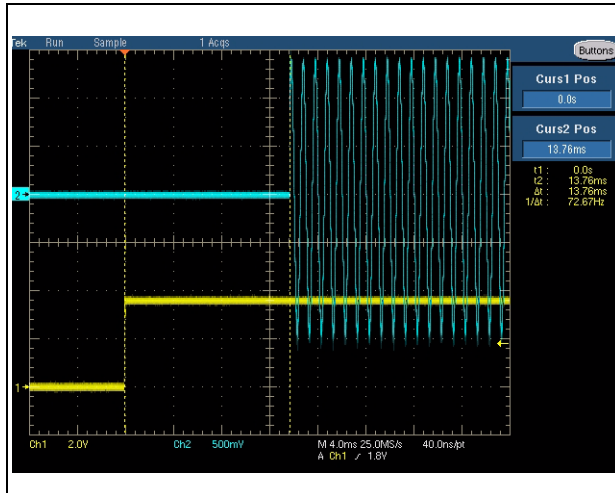
**Figure 60. CMRR vs. frequency, 32 Ω, V<sub>CC</sub> = 36 V, 0 dB**



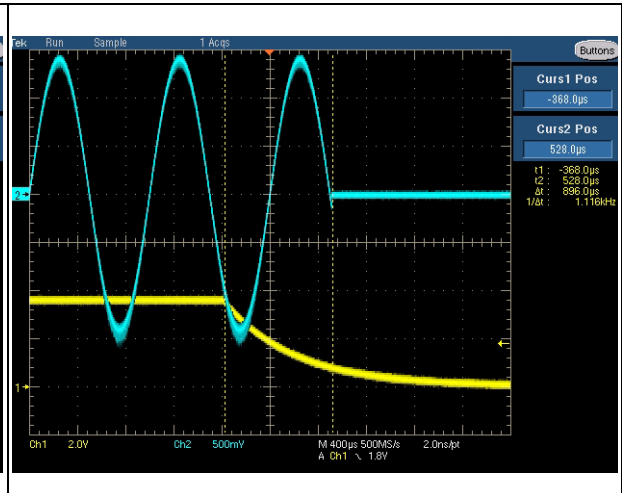
**Figure 61. CMRR vs. frequency, 32 Ω, V<sub>CC</sub> = 36 V, 6 dB**



**Figure 62. Wake-up time**



**Figure 63. Shutdown**





## 4 Application information

### 4.1 Gain control

The TS4621ML has two gain settings which are controlled via the GAIN pin:

GAIN voltage	Amplifier gain
$\leq 0.6 \text{ V}$	0 dB
$\geq 1.3 \text{ V}$	6 dB

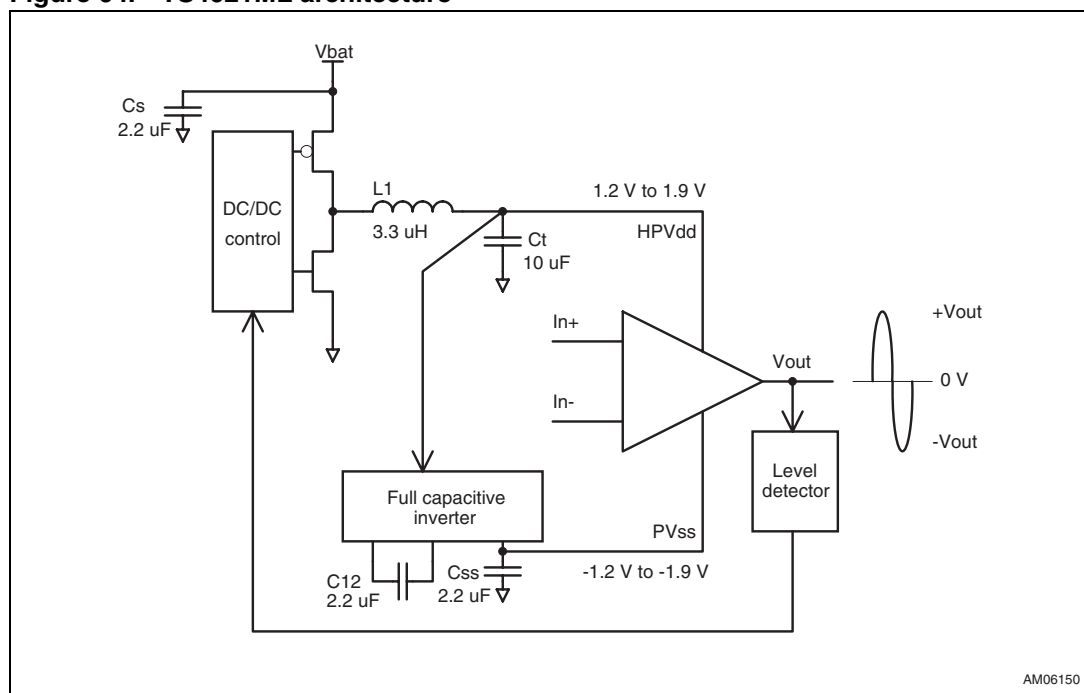
Note: See [Table 5: Electrical characteristics of the amplifier](#) for  $V_{IH}$  and  $V_{IL}$  levels.

### 4.2 Overview of the class-G, 2-level headphone amplifier

The TS4621ML uses what is referred to as *class-G operating mode*. This mode is a combination of the class AB biasing technique and an adaptive power supply. For this device, the power supply uses two levels:  $\pm 1.2 \text{ V}$  and  $\pm 1.9 \text{ V}$ .

To create the  $\pm 1.2 \text{ V}$  and  $\pm 1.9 \text{ V}$  levels, the device uses an internal high-efficiency step-down converter linked with a fully capacitive inverter from AVdd. Thanks to these internally-generated symmetrical power supply voltages, the output of the amplifier can be biased at 0 V, thus eliminating the classical bulky DC blocking output capacitors (typically more than 100  $\mu\text{F}$ ).

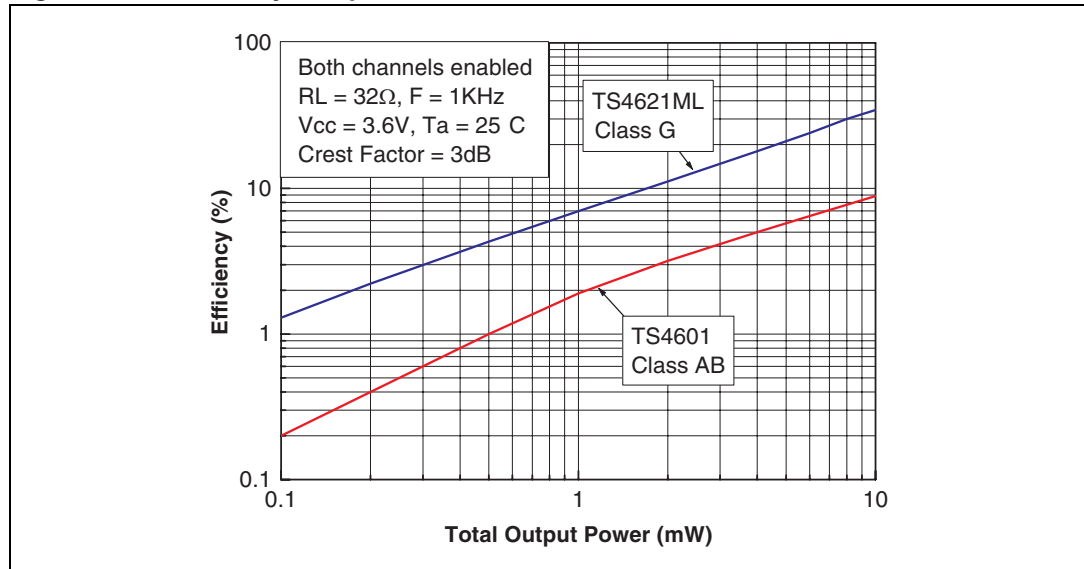
Figure 64. TS4621ML architecture



When an audio signal is playing with the TS4621ML, the class G feature adjusts in real time the internal power supply voltage in order to achieve the best efficiency possible. In addition, thanks to the fast transient response of the internal DC/DC converters, the switching between  $\pm 1.2 \text{ V}$  and  $\pm 1.9 \text{ V}$  can be achieved without audio clipping. Moreover, the out-of-

audio band DC/DC switching frequency keeps the audio quality at a high level (distortion, noise, etc...).

**Figure 65. Efficiency comparison**

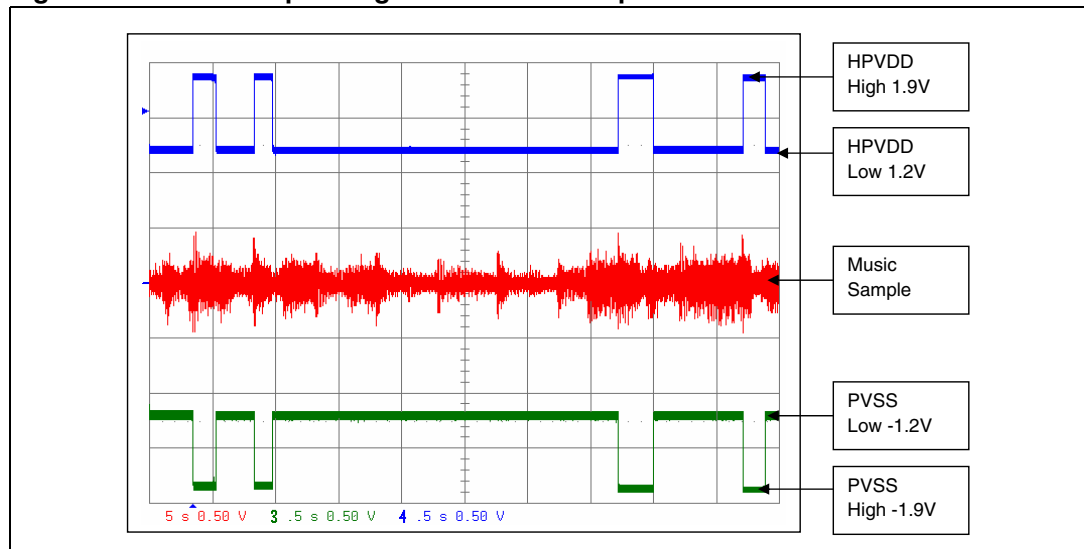


Most audio signals have a crest factor higher than 6 dB (10 dB on average), which means that most of the time the music level is low. In this case, the setting of the internal DC/DC converters is low (1.2 V) and in this way, helps to minimize the power dissipation.

When the audio signal amplitude increases due to a peak or louder music, the setting of the internal DC/DC converters increases to 1.9 V, automatically increasing the output dynamic range. This 1.9 V value remains until the end of the decay time.

Figure 66 shows a music sample played at high levels.

**Figure 66. Class-G operating with a music sample**



**Note:** HPVDD/PVSS voltages are created internally by DC/DC converters. To avoid destruction of the TS4621ML power amplifier, do not connect any external power supply on these pins.

## 4.3 External component selection

The TS4621ML requires few external passive components to operate correctly. Each component is described in the following sections.

### 4.3.1 Step-down inductor selection (L1)

The TS4621ML needs one inductor for the internal step-down DC/DC converter. This inductor must fit the following constraints:

- Typical value: 2.2  $\mu\text{H}$  to 3.3  $\mu\text{H}$  (3.3  $\mu\text{H}$  is recommended)
- Maximum current in operating mode: 400 mA
- Minimum inductor value at maximum current: 1.5  $\mu\text{H}$
- Maximum inductor value at zero current: 4.3  $\mu\text{H}$
- DC resistance: from 50 m $\Omega$  up to 450 m $\Omega$

[Table 6](#) shows the part number that should be used according to the inductor value.

**Table 6. Recommended inductor**

Manufacturer	Part number	Value
Murata	LQM21PN3R3NGRD	3.3 $\mu\text{H}$
	LQM2MPN3R3G0L	3.3 $\mu\text{H}$
	LQM2MPN2R2G0L	2.2 $\mu\text{H}$
FDK	MIPSZ2012D3R3	3.3 $\mu\text{H}$
	MIPSZ2012D2R2	2.2 $\mu\text{H}$

### 4.3.2 Step-down output capacitor selection (C<sub>T</sub>)

For the internal DC/DC step-down converter, the TS4621ML needs one output capacitor.

The three criteria for selecting the output capacitor are the range value of the capacitor including self tolerance, DC variation and the minimum ESR value, which is mandatory to avoid oscillation of the converter. Therefore the following constraints must be observed.

- Typical capacitor value: 10  $\mu\text{F}$  at DC = 0 V
- Maximum capacitor value: 12  $\mu\text{F}$  at DC = 0 V
- Minimum capacitor value: 4.8  $\mu\text{F}$  at DC = 2 V
- Voltage range across this capacitor: from 1.1 V to 2 V
- Minimum DC ESR value: 5 m $\Omega$

A ceramic capacitor in a 0603-type package is also recommended because of its close placement to the TS4621ML, which makes it easier to minimize parasitic inductance and resistance that have a negative impact on the audio performance.

**Table 7. Recommended capacitors**

Manufacturer	Part number	Value
Murata	GRM188R60J106ME47	10 $\mu$ F, 6.3 V, X5R
	GRM188R60J106ME84	10 $\mu$ F, 6.3 V, X5R
	GRM188R61E106ME73	10 $\mu$ F, 25 V, X5R

### 4.3.3 Full capacitive inverter capacitors selection (C12 and C<sub>SS</sub>)

Two capacitors (C12 and C<sub>SS</sub>) are needed for this internal DC/DC inverter.

The three criteria for selecting these capacitors are the range value of the capacitor including self tolerance, DC variation and the minimum ESR to minimize power losses.

- Typical capacitor value: 2.2  $\mu$ F +/-20 %
- Voltage across these capacitors: from 1.1 V to 2 V
- Minimum capacitor value: 1  $\mu$ F

Again, a ceramic capacitor in a 0603 or 0402-type package is also recommended because of their close placement to the TS4621ML, which makes it easier to minimize parasitic inductance and resistance that have a negative impact on the audio performance.

### 4.3.4 Power supply decoupling capacitor selection (C<sub>s</sub>)

A 2.2  $\mu$ F decoupling capacitor with low ESR is recommended for positive power supply decoupling. Packages such as the 0402 or 0603 are also recommended because of their close placement to the TS4621ML, which makes it easier to minimize parasitic inductance. It is advised to choose a X5R dielectric for capacitor tolerance, and a 10 V DC rating voltage for 4.8 V operations (or a 6.3 V DC rating voltage for 3.6 V operations), to take into consideration the  $\Delta C/\Delta V$  variation of this type of ceramic capacitor.

An important parameter is the rated voltage of the capacitor. A 2.2  $\mu$ F/6.3 V capacitor used at 4.8 V DC typically loses about 40 % of its value. In fact, with a 4.8 V power supply voltage, the decoupling value is about 1.3  $\mu$ F instead of 2.2  $\mu$ F. Because the decoupling capacitor influences the THD+N in the medium-to-high frequency region, this capacitor variation becomes decisive. In addition, less decoupling means higher overshoots, which can be problematic if they reach the power supply's AMR value (5.5 V). This is why, for a 2.2  $\mu$ F value, we recommend a 2.2  $\mu$ F/10 V, a 4.7  $\mu$ F/6.3 V or a ceramic capacitor with a low DC bias variation rated at 6.3 V.

### 4.3.5 Input coupling capacitor selection (C<sub>in</sub>)

C<sub>in</sub> input coupling capacitors are mandatory for the TS4621ML's operation. They block any DC component coming from the audio signal source.

C<sub>in</sub> with R<sub>in</sub> form a first-order high-pass filter and the -3 dB cut-off frequency is:

$$FC(-3dB) = \frac{1}{2 \times \pi \times R_{in} \times C_{in}}$$

R<sub>in</sub> is the single-ended input impedance that can be approximated at about R<sub>indiff</sub>/2.

R<sub>in</sub> also depends on the gain setting. [Figure 10](#) provides the differential input impedance vs. gain. One can also see that R<sub>indiff</sub> is minimum for the maximum gain setting (that is, 6 dB).

Therefore, in most cases,  $R_{in}$  should be set to 6 dB to calculate the minimum input capacitor  $C_{in}$ .

**Example:**

In this case and for a -3 dB cut-off frequency of 20 Hz,  $C_{in} = 0.64 \mu\text{F}$ . The closest normalized value is  $0.68 \mu\text{F}$  but a  $1 \mu\text{F}$  capacitor is more suitable to take into consideration the capacitor tolerance +/-20 %.

If the aim is to have the 20 Hz at -1 dB, the capacitor has to be multiplied by 1.96. As such,  $C_{in} = 0.64 \times 1.96 = 1.25 \mu\text{F}$ . The closest normalized value would be  $1.5 \mu\text{F}$  or  $2.2 \mu\text{F}$ .

### 4.3.6 Low-pass output filter ( $R_{out}$ and $C_{out}$ ) and IEC 61000-4-2 ESD protection

The TS4621ML is designed to operate with a passive first-order low-pass filter (as shown in [Figure 1](#)). This low-pass filter is mandatory to ensure correct operation of the TS4621ML over the volume range and output capacitance range vs. load.

$R_{out}$  must have a value of  $12 \Omega$  minimum and  $C_{out}$  a value of  $0.8 \text{ nF}$  minimum up to  $100 \text{ nF}$  maximum. Values of  $12 \Omega$  and  $1 \text{ nF}$  are a good starting point for a design to be able to drive a classic headphone ( $16 \Omega$ ,  $32 \Omega$ ,  $60 \Omega$ ) and the line-in of any hi-fi system or sound card. The cutoff frequency of this filter ( $12 \Omega$  and  $1 \text{ nF}$ ) is approximately  $13 \text{ MHz}$  and clearly above the audio band.

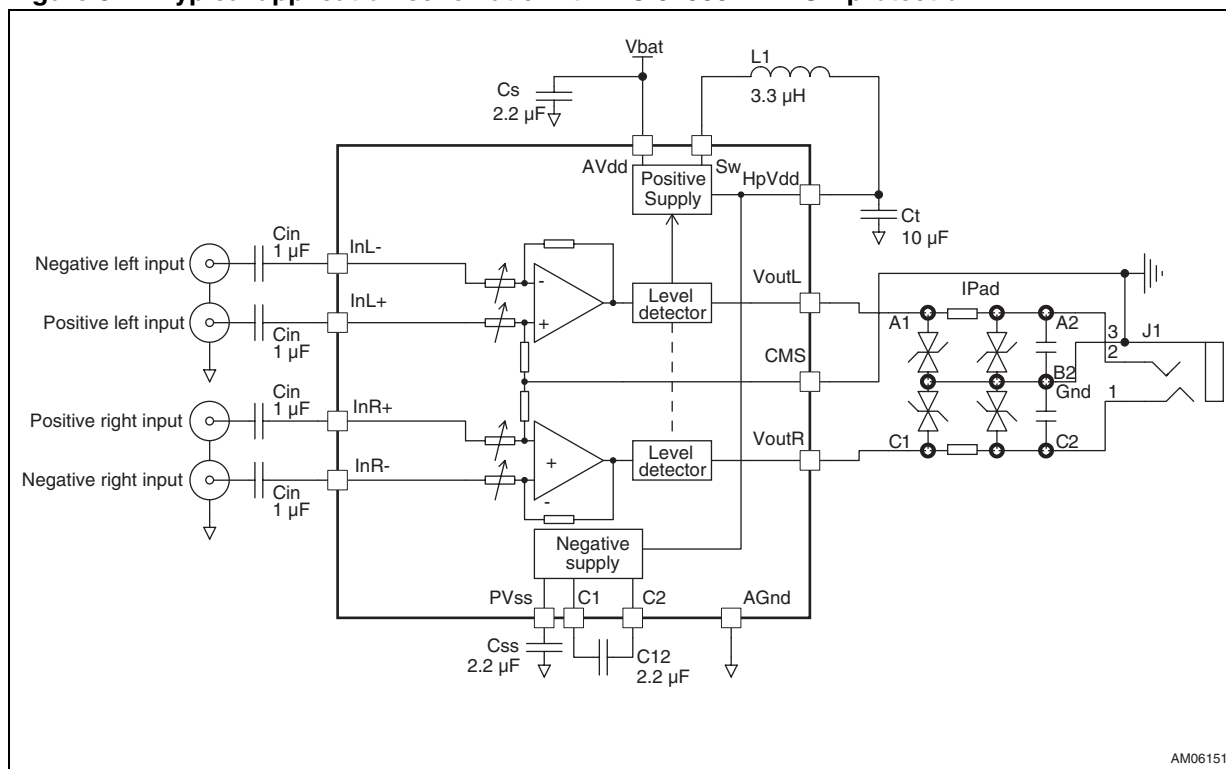
However, this output RC filter is also a part of the IEC 61000-4-2 ESD protection. In most cases, this RC filter is designed with transient absorbers and the final solution can be a discrete solution or an integrated solution. ST Microelectronics' portfolio has many integrated solutions for ESD, but one dedicated to headphone amplifiers in particular: IPAD<sup>(a)</sup> reference EMIF02-AV01F3.

To fit the IEC 61000-4-2 standard, this audio line IPAD can be added to the output of the TS4621ML as shown in [Figure 67](#).

---

a. Copyright STMicroelectronics.

Figure 67. Typical application schematic with IEC 61000-4-2 ESD protection



By adding this ESD protection, the TS4621ML complies with the IEC 61000-4-2 level 4 standard on jack pins. Our demonstration board has been tested using the same conditions as those outlined in the IEC 61000-4-2 standard. Results may differ depending on the layout of the PCB.

- 15 kV (air discharge)
- 8 kV (contact discharge)

This IPAD has an internal series resistor  $R_{out} = 15 \Omega \pm 20\%$  and an output capacitor  $C_{out} = 3.2 \text{ nF} \pm 25\%$ .

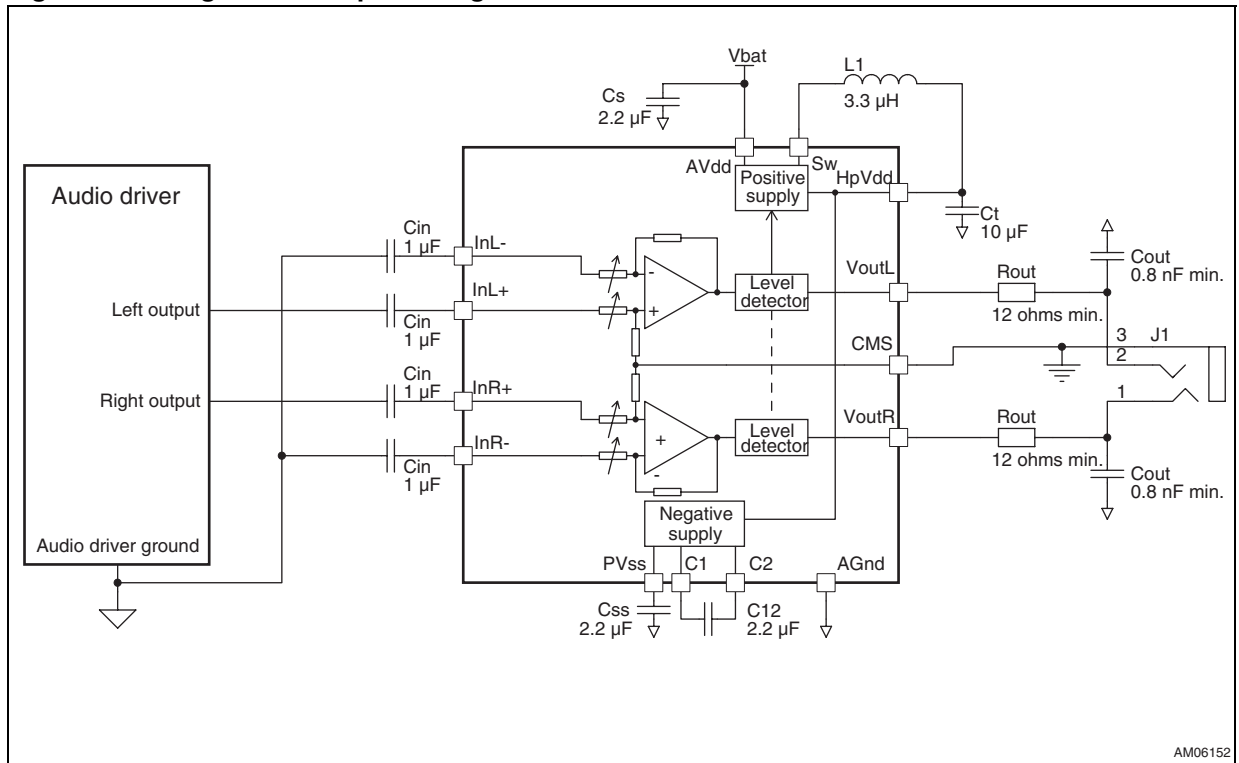
### 4.3.7 Integrated input low-pass filter

The TS4621ML has an integrated internal first-order low-pass filter with a -3 dB cutoff. This integrated filter is present on each input and filters any out-of-band audio noise coming from the audio source.

## 4.4 Single-ended input configuration

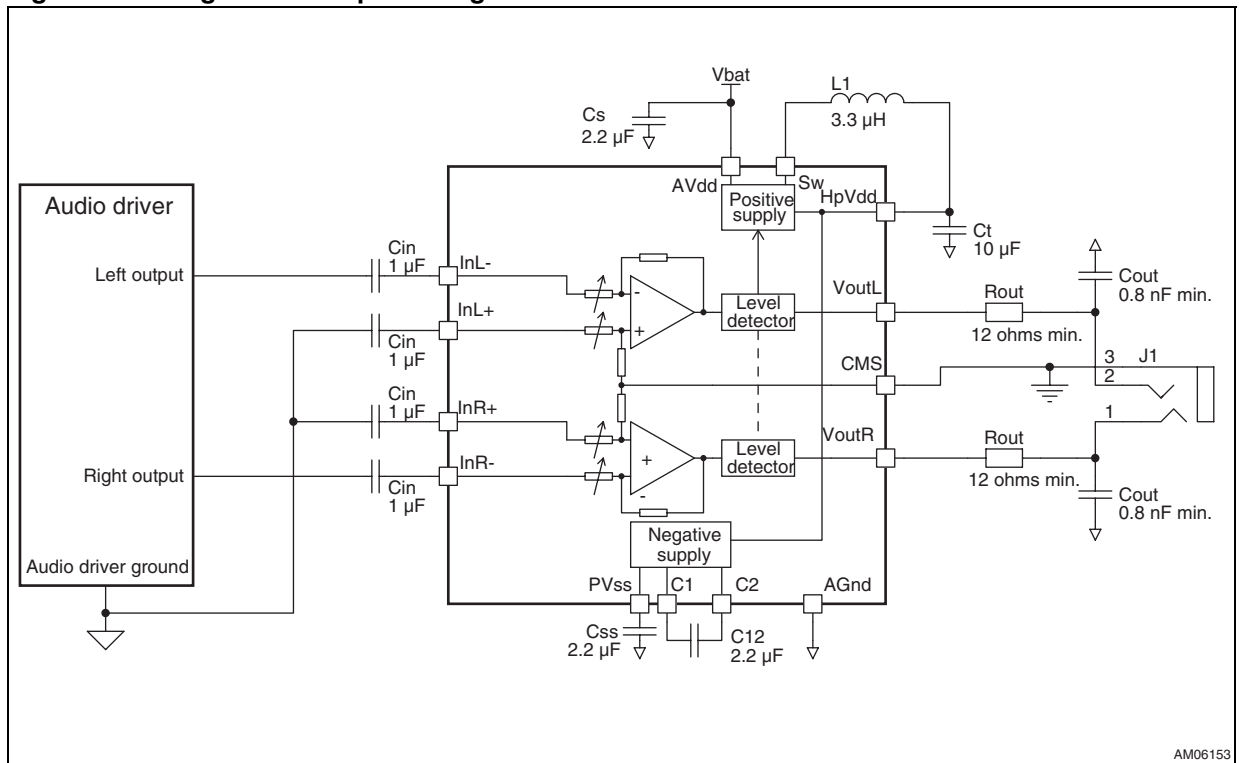
The TS4621ML can be used in a single-ended input configuration. InR- and InL- or InR+ and InL+ can be shorted to ground through input capacitors. All  $C_{in}$  capacitors must have the same value to keep the same PSRR performance as in a differential input configuration. [Figure 68](#) and [Figure 69](#) show how to connect the TS4621ML. Note the ground connection of each input. To avoid PSRR issues resulting from any ground noise, this connection must be done on the ground of the audio source and not on the ground of the TS4621ML itself.

Figure 68. Single-ended input configuration1



AM06152

Figure 69. Single-ended input configuration 2



AM06153

The gain range in these configurations remains unchanged and is given by:

$$V_{outLR} = V_{inLR} \times \text{Gain}$$

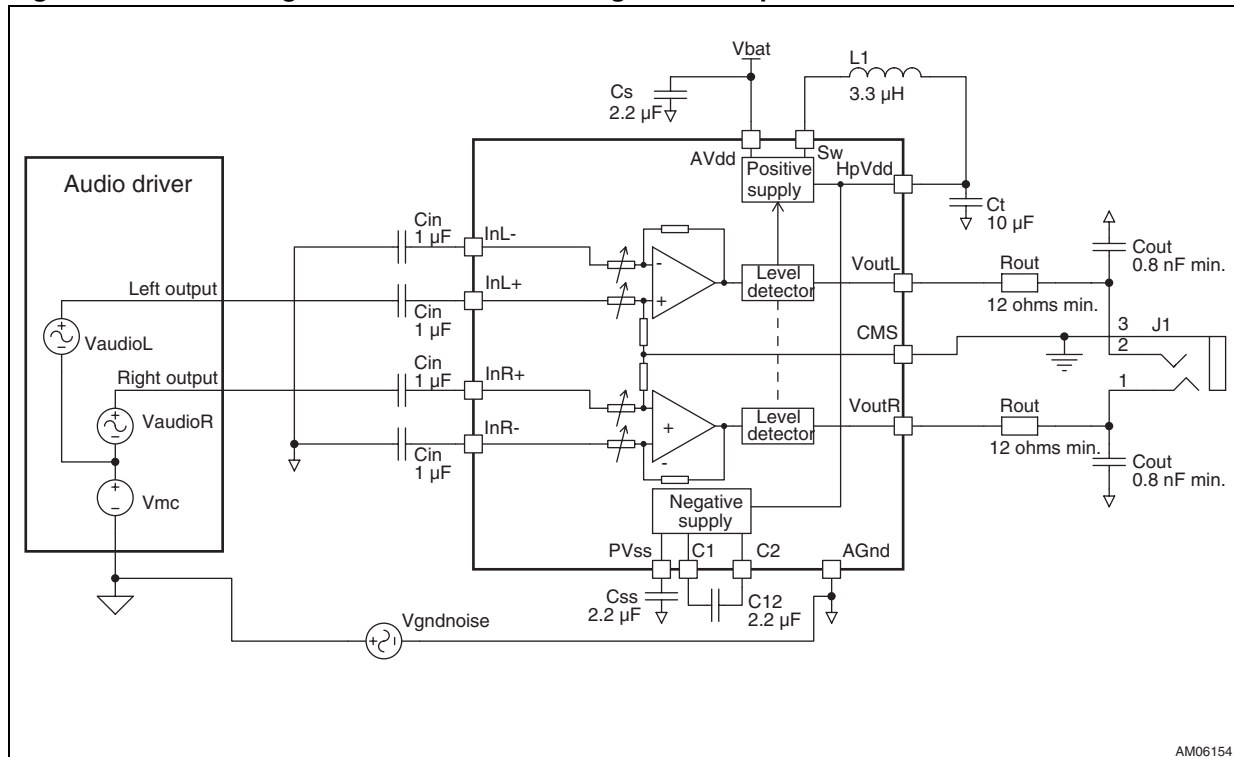
With reference to [Figure 69](#), note that the absolute phase in the audio band is 180°.

### 4.4.1 Layout recommendations for single-ended operation

The connection location of each input that has to be set to ground is extremely important.

#### Incorrect connection location

**Figure 70. Incorrect ground connection for single-ended option**



If these inputs are connected to AGnd (the ground of the TS4621ML class-G), the output voltage can be expressed by the following simplified equation from an AC point of view.

#### Equation 1

$$V_{out} = A_v \times (V_{audio} + V_{mc} + V_{gndnoise}) + V_{batnoise} \times \text{PSRR}$$

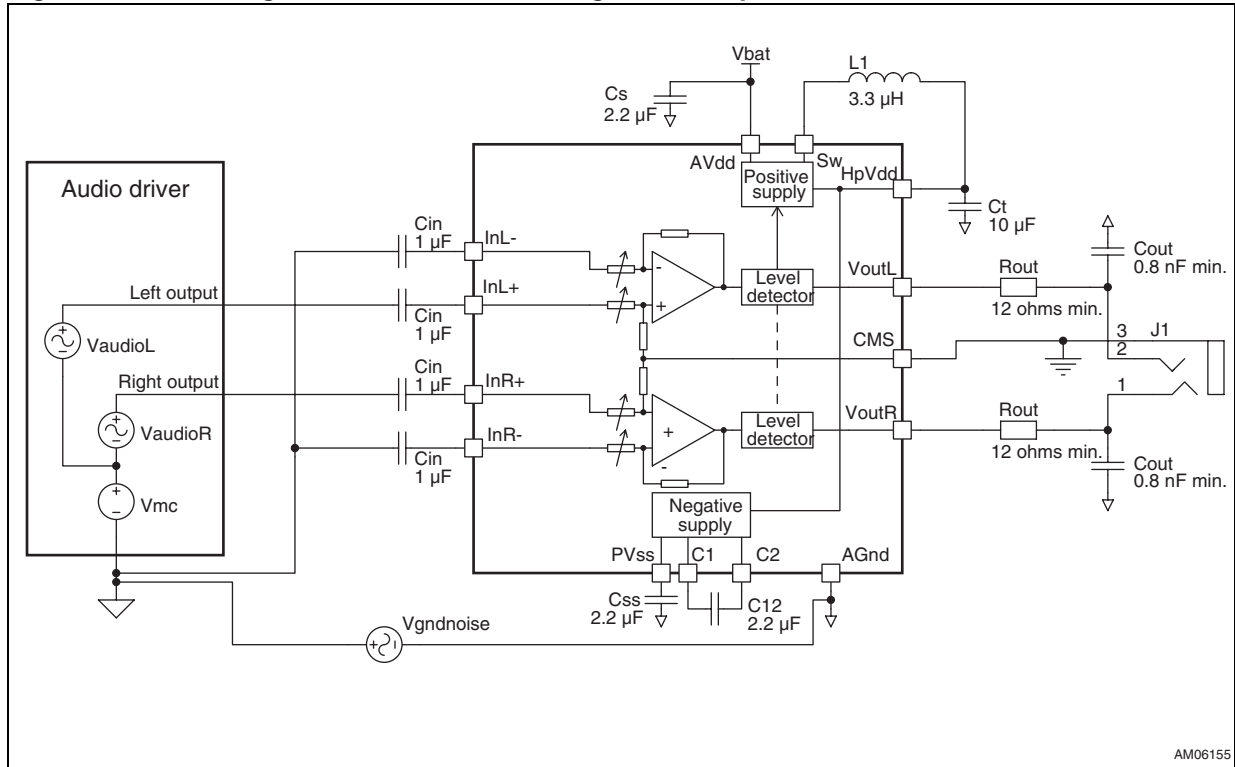
As shown in [Equation 1](#), any ground noise and any parasitic AC voltage on Vmc is directly multiplied by the gain of the amplifier. If Vmc can be totally controlled by the design of the audio source device (no parasitic AC voltage), it is not necessarily the case for Vgndnoise. This noise can be significantly reduced by an adequate low impedance ground plane, but not totally eliminated. In practice, only ten millivolts in the right frequency range are enough to produce an audible parasitic sound in the headphone with a volume level as low as -20 dB.



**Correct connection location**

As shown in [Figure 71](#), the best option is to route the single-ended signal in parallel with the AC ground line of the other input. The AC grounded terminal must be routed in parallel to the audio signal and grounded with the ground of the audio source.

**Figure 71. Correct ground connection for single-ended option**



In this configuration, the AC output voltage is:

**Equation 2**

$$V_{out} = A_v \times (V_{audio} + V_{mc}) + V_{gndnoise} \times CMRR + V_{batnoise} \times PSRR$$

In [Equation 2](#) the ground noise is attenuated by the performance of the CMRR. In practice, 50 dB of CMRR and ten millivolts for ground noise gives an output of approximately 30 µV, which is normally too low to be perceptible in the headphone. If Vmc is also totally controlled by the design of the audio source, [Equation 2](#) becomes:

**Equation 3**

$$V_{out} = A_v \times V_{audio} + V_{batnoise} \times PSRR$$

Like in differential mode, the main contributor for audio signal degradation is the AC noise voltage on Vbat. Thanks to the TS4621ML's very high PSRR that can attenuate GSM burst noise, [Equation 3](#) becomes:

**Equation 4**

$$V_{out} = A_v \times V_{audio}$$

## 4.5 Startup phase

The TS4621ML uses different techniques to reduce the DC current consumption and offer a pop-and-click performance close to none.

### 4.5.1 Auto zero technology

During the startup phase, the differential output voltage is sensed and adjusted to 0 V ( $\pm 500 \mu\text{V}$ ) to avoid any pop noise when the amplifier becomes operational. This also helps to minimize extra current consumption due to the load ( $I_{\text{cc-extra}} = V_{\text{outDC}} / R_{\text{load}}$ ).

### 4.5.2 Input impedance

The TS4621ML requires input coupling capacitors. The usual lowest frequency used for the headphone is close to 20 Hz. This frequency means a constant time for a first-order high-pass filter of approximately  $1 / (2 \times \pi \times 20) = 8 \text{ ms}$ .

To achieve 95 % of the capacitor's charge, it is necessary to wait  $3 \times 8 \text{ ms} = 24 \text{ ms}$ , which is out of range for a device with a fast startup time.

Because of the mismatching of all input capacitors and input resistors, if it is decided to start the TS4621ML at a time of 8 ms, a voltage difference at the inputs (multiplied by the gain) can create a voltage step on the output and consequently a pop noise.

To avoid this issue during the starting phase, the TS4621ML accelerates the charging of the input capacitors by reducing the input impedance to 2 k $\Omega$ .

In such a case, for a 1  $\mu\text{F}$  capacitor the 95 % charge is reached in 6 ms. As the startup time of TS4621ML is 12 ms, there remains sufficient time to fully charge the input capacitors and as such eliminate any pop noise.

## 4.6 Layout recommendations

Particular attention must be given to the correct layout of the PCB traces and wires between the amplifier, load and power supply (in most cases, the battery of the cellular phone).

The power and ground traces are critical since they must provide adequate energy and grounding for all circuits. Good practice is to use short and wide PCB traces to minimize voltage drops and parasitic inductance.

A track with a width of at least 200  $\mu\text{m}$  for a copper thickness of 18  $\mu\text{m}$  is recommended for bringing energy to the amplifier from the battery.

Proper grounding guidelines help improve audio performances, minimize crosstalk between channels, and prevent switching noise from coupling into the audio signal. It is also recommended to use a large-area and multi-via ground plane to minimize parasitic impedance.

A multi-layer PCB board allows double or multiple ground planes to be implemented. Most of the time, the top and bottom layers are used as ground planes and provide shielding for tracks routed on the intermediate layers. In addition, to minimize parasitic impedance over the entire surface, a multi-via technique that connects the bottom and top layer ground planes together in many locations is often used.

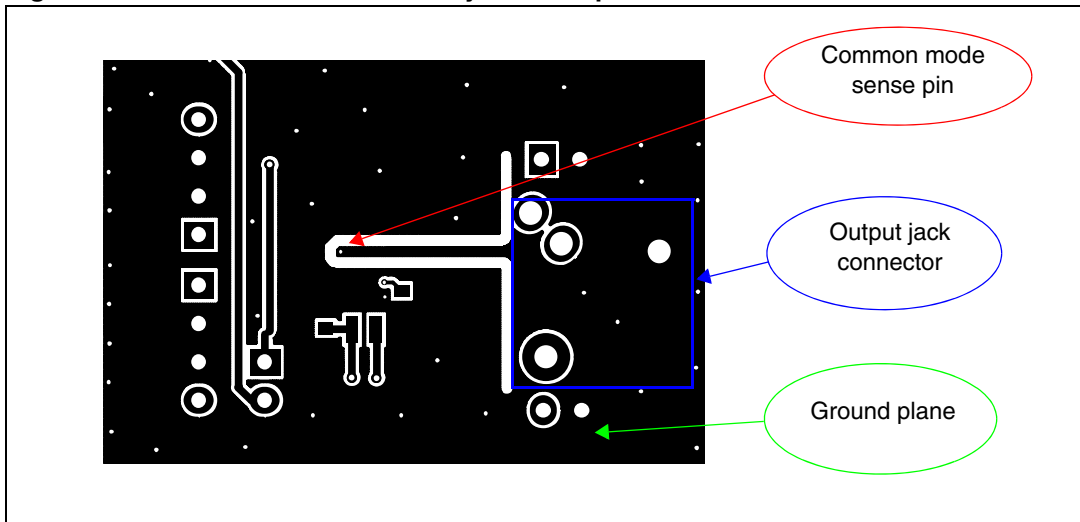
The copper traces that connect the output pins to the load and supply pins should be as wide as possible to minimize the trace resistances.

### 4.6.1 Common-mode sense layout

The TS4621ML implements a common-mode sense pin to correct any voltage differences that might occur between the return of the headphone jack and the AGND of the device that can create parasitic noise in the headphone and/or line out.

The solution to strongly reduce and practically eliminate this noise consists in connecting the headphone jack ground to the CMS pin. This pin senses the difference of potential (voltage noise) between the TS4621ML ground and the headphone ground. Thanks to the frequency response and the attenuation of the common-mode sense pin, this noise is removed from the TS4621ML outputs.

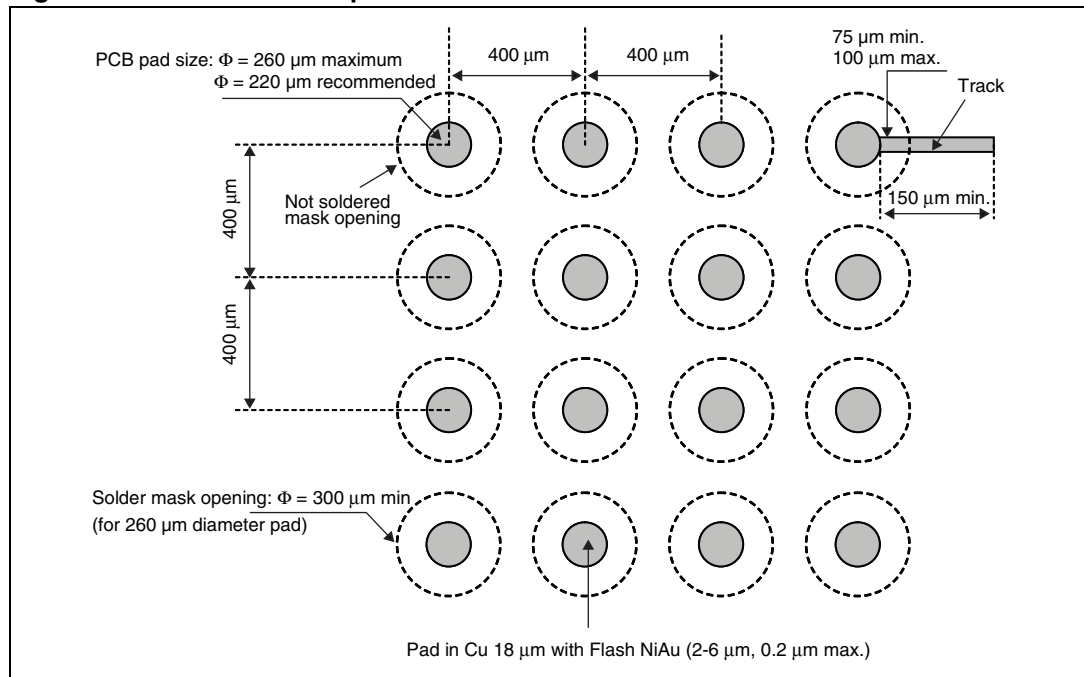
**Figure 72. Common-mode sense layout example**



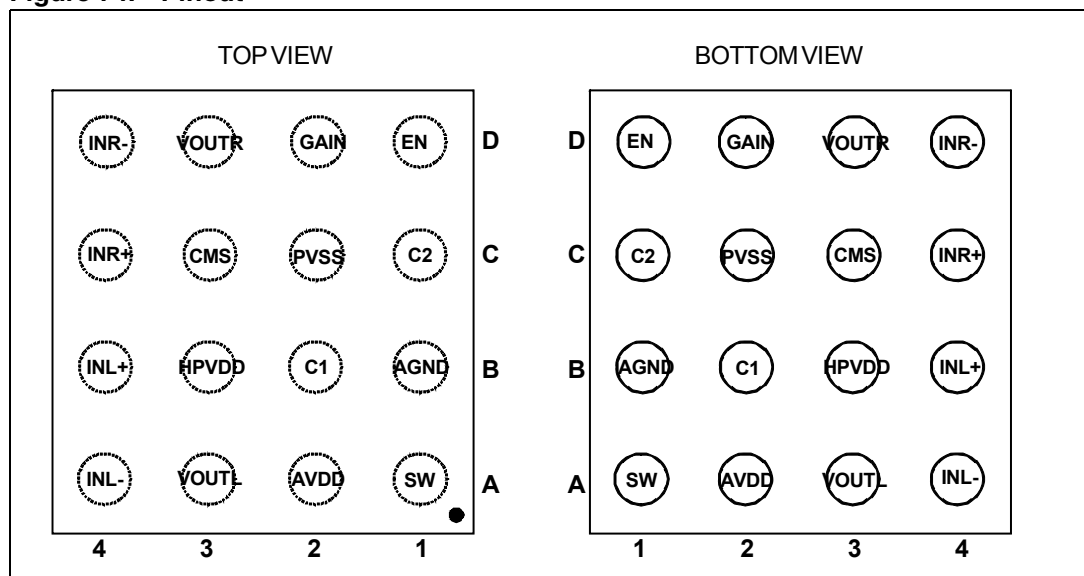
## 5 Package information

In order to meet environmental requirements, ST offers these devices in different grades of ECOPACK® packages, depending on their level of environmental compliance. ECOPACK® specifications, grade definitions and product status are available at: [www.st.com](http://www.st.com). ECOPACK® is an ST trademark.

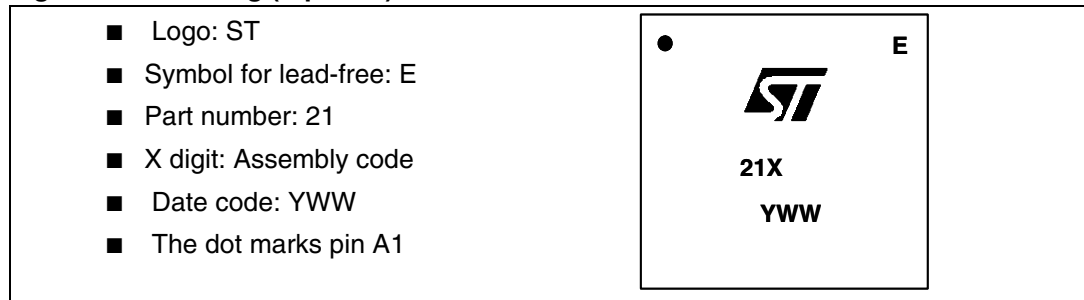
**Figure 73. TS4621ML footprint recommendation**



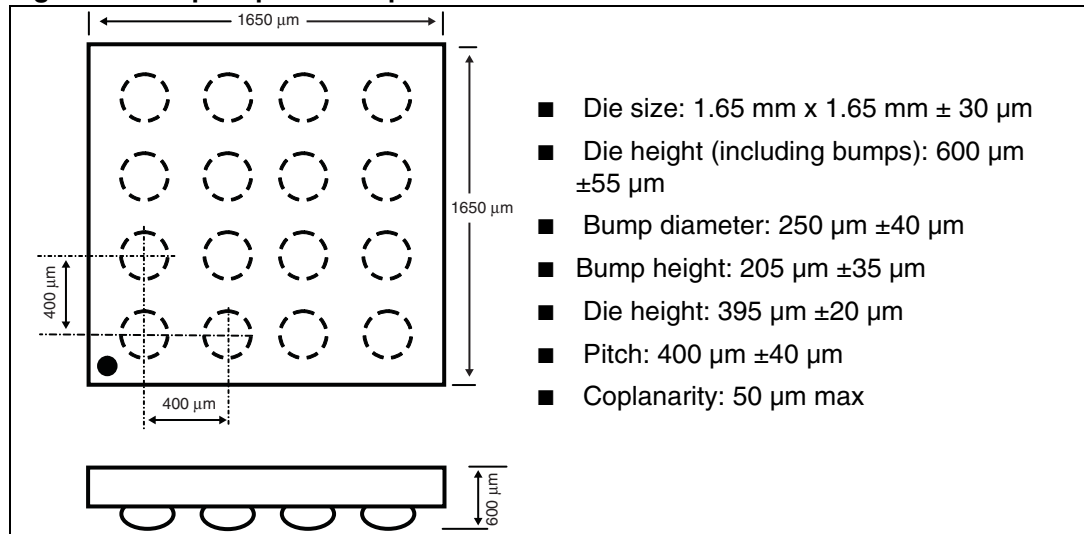
**Figure 74. Pinout**



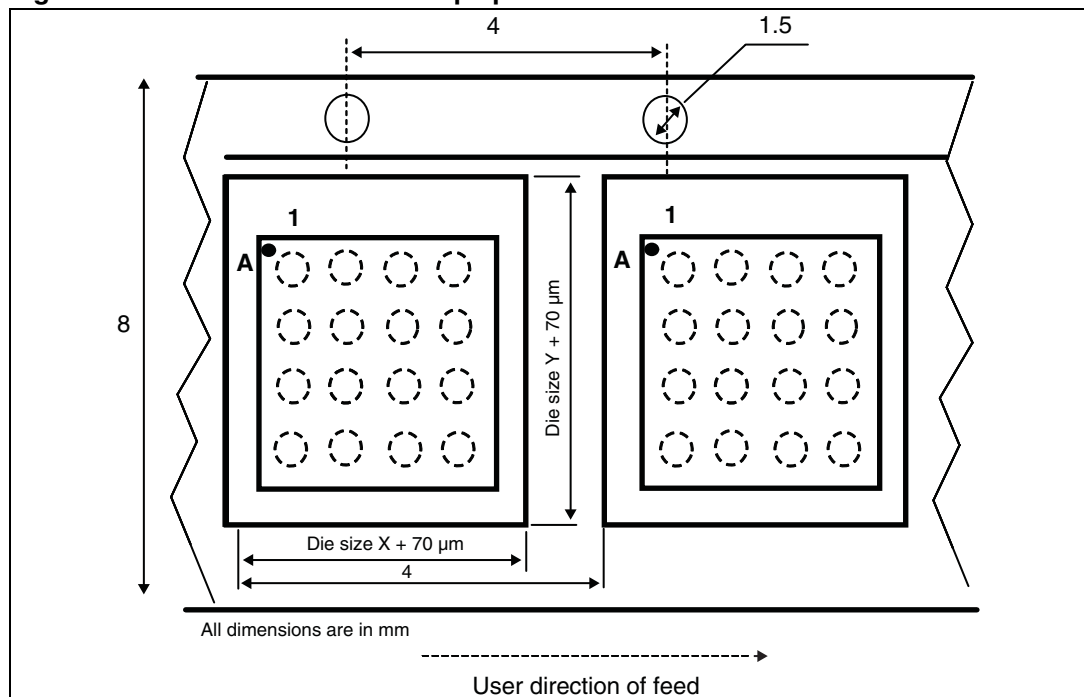
**Figure 75. Marking (top view)**



**Figure 76. Flip-chip - 16 bumps**



**Figure 77. Device orientation in tape pocket**



## 6 Ordering information

**Table 8. Order codes**

Order code	Temperature range	Package	Packing	Marking
TS4621MLEIJT	-40°C to +85°C	Flip-chip	Tape & reel	21

## 7 Revision history

**Table 9. Document revision history**

Date	Revision	Changes
07-May-2011	1	Initial release.

**Please Read Carefully:**

Information in this document is provided solely in connection with ST products. STMicroelectronics NV and its subsidiaries ("ST") reserve the right to make changes, corrections, modifications or improvements, to this document, and the products and services described herein at any time, without notice.

All ST products are sold pursuant to ST's terms and conditions of sale.

Purchasers are solely responsible for the choice, selection and use of the ST products and services described herein, and ST assumes no liability whatsoever relating to the choice, selection or use of the ST products and services described herein.

No license, express or implied, by estoppel or otherwise, to any intellectual property rights is granted under this document. If any part of this document refers to any third party products or services it shall not be deemed a license grant by ST for the use of such third party products or services, or any intellectual property contained therein or considered as a warranty covering the use in any manner whatsoever of such third party products or services or any intellectual property contained therein.

**UNLESS OTHERWISE SET FORTH IN ST'S TERMS AND CONDITIONS OF SALE ST DISCLAIMS ANY EXPRESS OR IMPLIED WARRANTY WITH RESPECT TO THE USE AND/OR SALE OF ST PRODUCTS INCLUDING WITHOUT LIMITATION IMPLIED WARRANTIES OF MERCHANTABILITY, FITNESS FOR A PARTICULAR PURPOSE (AND THEIR EQUIVALENTS UNDER THE LAWS OF ANY JURISDICTION), OR INFRINGEMENT OF ANY PATENT, COPYRIGHT OR OTHER INTELLECTUAL PROPERTY RIGHT.**

**UNLESS EXPRESSLY APPROVED IN WRITING BY TWO AUTHORIZED ST REPRESENTATIVES, ST PRODUCTS ARE NOT RECOMMENDED, AUTHORIZED OR WARRANTED FOR USE IN MILITARY, AIR CRAFT, SPACE, LIFE SAVING, OR LIFE SUSTAINING APPLICATIONS, NOR IN PRODUCTS OR SYSTEMS WHERE FAILURE OR MALFUNCTION MAY RESULT IN PERSONAL INJURY, DEATH, OR SEVERE PROPERTY OR ENVIRONMENTAL DAMAGE. ST PRODUCTS WHICH ARE NOT SPECIFIED AS "AUTOMOTIVE GRADE" MAY ONLY BE USED IN AUTOMOTIVE APPLICATIONS AT USER'S OWN RISK.**

Resale of ST products with provisions different from the statements and/or technical features set forth in this document shall immediately void any warranty granted by ST for the ST product or service described herein and shall not create or extend in any manner whatsoever, any liability of ST.

ST and the ST logo are trademarks or registered trademarks of ST in various countries.

Information in this document supersedes and replaces all information previously supplied.

The ST logo is a registered trademark of STMicroelectronics. All other names are the property of their respective owners.

© 2012 STMicroelectronics - All rights reserved

STMicroelectronics group of companies

Australia - Belgium - Brazil - Canada - China - Czech Republic - Finland - France - Germany - Hong Kong - India - Israel - Italy - Japan - Malaysia - Malta - Morocco - Philippines - Singapore - Spain - Sweden - Switzerland - United Kingdom - United States of America

[www.st.com](http://www.st.com)