

# MPPC modules

C10507-11 series C10751 series

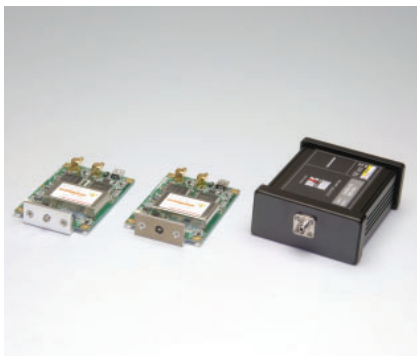

## Photon counting module with built-in MPPC®

The MPPC (multi-pixel photon counter) module is a photon counting module capable of low-light-level detection. This module consists of an MPPC device, current-to-voltage converter circuit, high-speed comparator circuit, high-voltage power supply circuit, temperature-compensation circuit, counter circuit, and microcomputer. The module also has a USB 1.1 port for connecting to a PC. The threshold level (detection level for one photon) can be changed from a PC. The MPPC module is designed to extract maximum MPPC performance and so yields excellent photon counting characteristics. The MPPC module is expected to open up new applications in the photon counting region, including fluorescence measurement, DNA analysis, environmental chemical analysis, high energy physics experiments, and many other fields.

The C10751 series conforms to EU EMC directives and has an FC-type optical fiber connector for easy coupling to an optical fiber.

### Features

- Integrates a signal readout circuit ideal for MPPC
- Built-in high-voltage circuit and temperature-compensated circuit
- Three types of output: analog, comparator and pulse count
- USB interface for easy handling
- Driven by USB bus power (no external power supply required)
- Compact and lightweight

### Applications

- Ultra low light detection
- Analysis equipment
- Fluorescence measurement
- Particle counters
- Bioluminescence analysis

### Selection guide

Type no.	Internal MPPC				Type no.
	Number of pixels	Pixel size (μm)	Package	Effective photosensitive area (mm)	
C10507-11-025U	1600	25 × 25	Metal	1 × 1	S10362-11-025U
C10507-11-050U	400	50 × 50			S10362-11-050U
C10507-11-100U	100	100 × 100			S10362-11-100U
C10507-11-025C	1600	25 × 25	Ceramic		S10362-11-025C
C10507-11-050C	400	50 × 50			S10362-11-050C
C10507-11-100C	100	100 × 100			S10362-11-100C
CE compliant C10751-01	1600	25 × 25	Metal		S10362-11-025U
CE compliant C10751-02	400	50 × 50			S10362-11-050U
CE compliant C10751-03	100	100 × 100			S10362-11-100U

Note: The last letter of each type number indicates package materials (U: metal, C: ceramic).

### Specifications (Ta=25 °C, unless otherwise noted)

Parameter	Condition	Min.	Typ.	Max.	Unit	
Operating temperature			-10 to +40		°C	
Storage temperature			-20 to +50		°C	
Spectral response range			320 to 900		nm	
Peak sensitivity wavelength			440		nm	
Photon detection efficiency*1	*2	$\lambda = \lambda_p$	-	20	-	%
	*3	0.5 p.e.	-	35	-	
	*4	(Threshold level)	-	45	-	
Dark count	*2	0.5 p.e.	-	500	900	kcps
	*3	(Threshold level)	-	600	1200	
	*4		-	900	1500	
Analog output voltage*5		80	100	120	mV/p.e.	
Temperature stability of analog output voltage	25 ± 10 °C	-	±2.5	±5	%	
Comparator output		TTL compatible			-	
Comparator threshold level		0.5, 1.5, 2.5, 3.5, 4.5, 5.5, 6.5, 7.5 disable adjustable 9 states			p.e.	
Interface		USB 1.1			-	

\*1: Photon detection efficiency includes effects crosstalk and afterpulses.

\*2: C10507-11-025U, C10507-11-025C, C10751-01

\*3: C10507-11-050U, C10507-11-050C, C10751-02

\*4: C10507-11-100U, C10507-11-100C, C10751-03

\*5: Cannot be changed. Should be used with 50 Ω termination.

### Block diagram

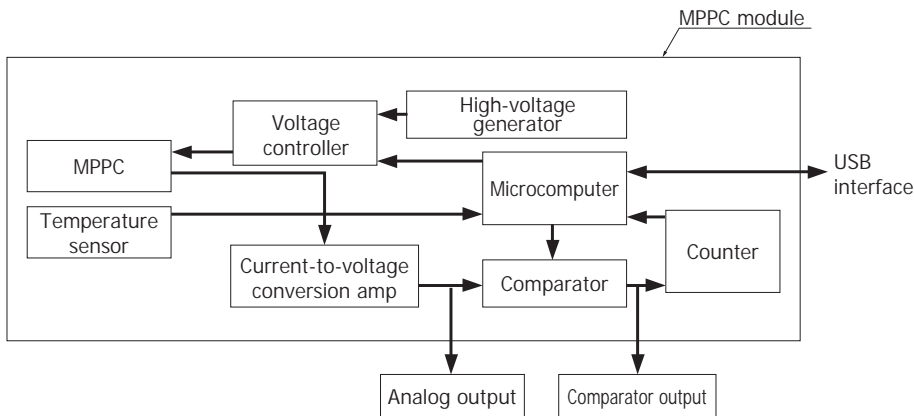

KACCC0343EB

Measurement examples

Analog output (C10507-11-025U)

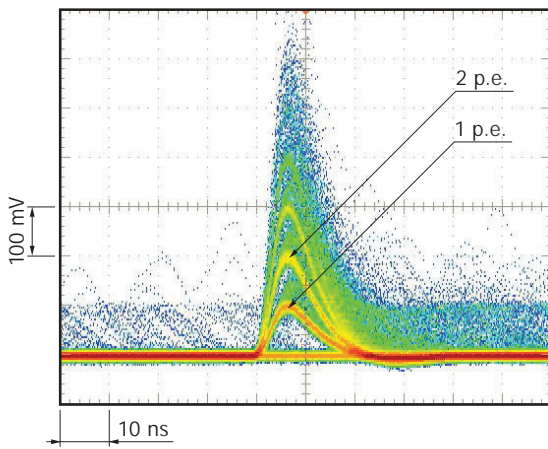

Analog output (C10507-11-050U)

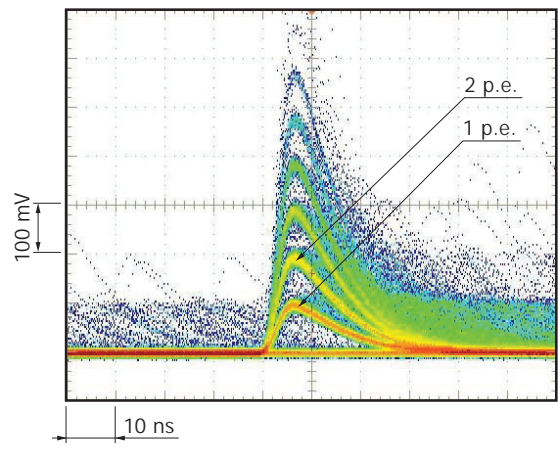

Analog output (C10507-11-100U)

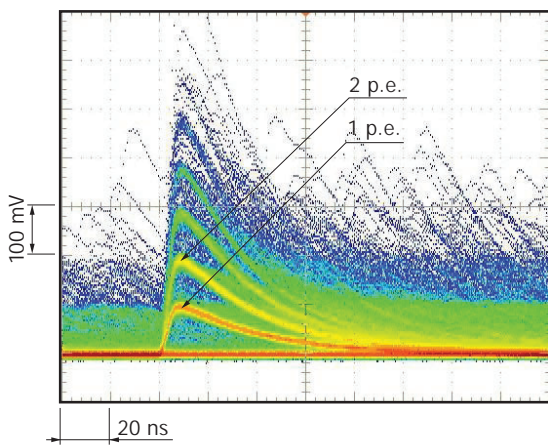

Comparator output

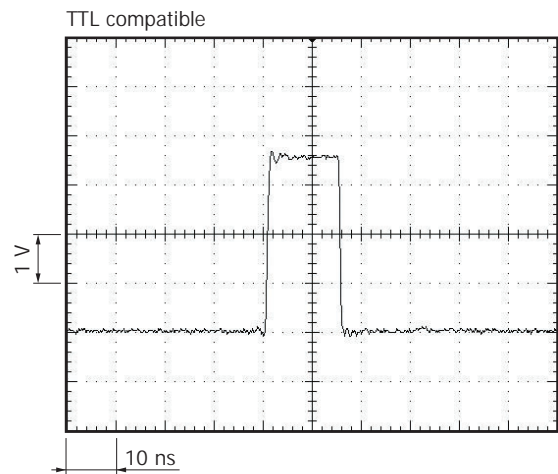

Measurement setup

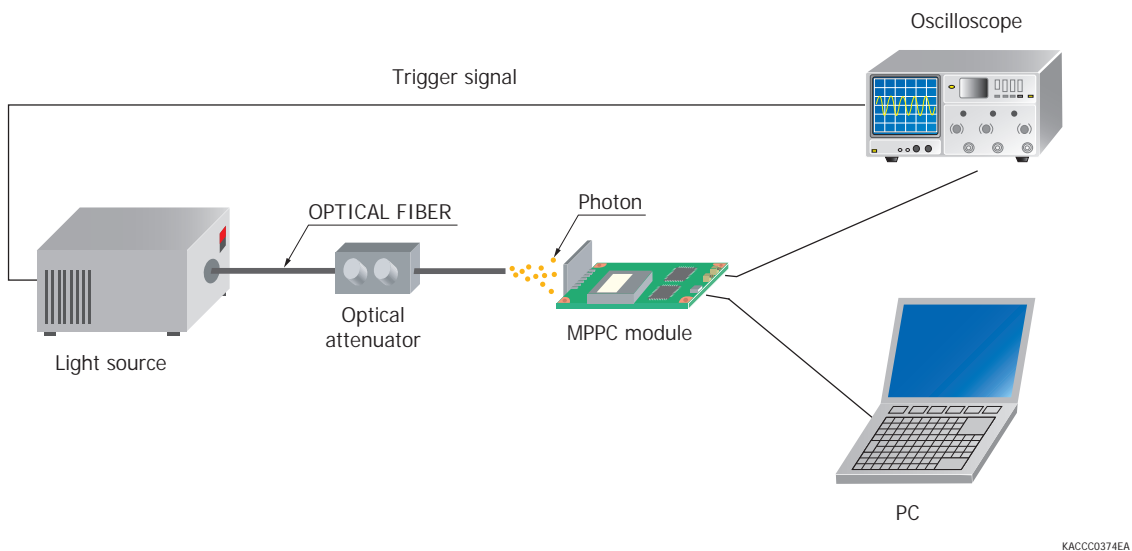

Photon detection efficiency vs. wavelength (typical example)

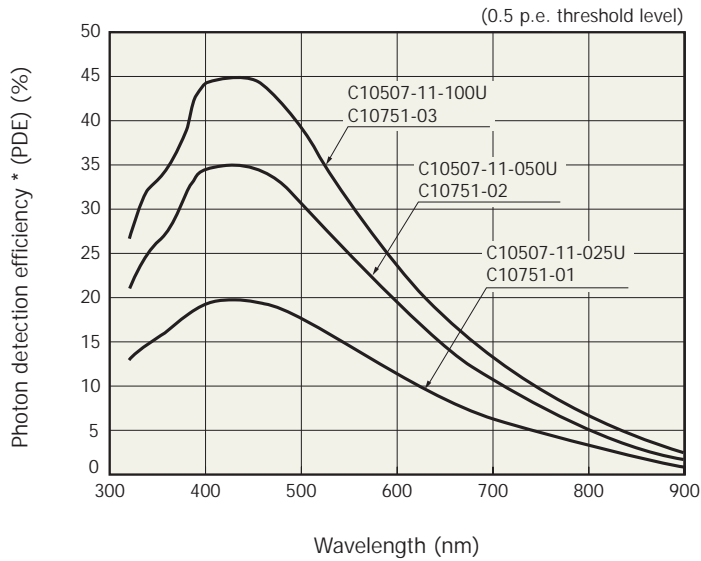

\* Photon detection efficiency includes effects of crosstalk and afterpulses.

KACCB0180ED

Saturation output voltage (typical example)

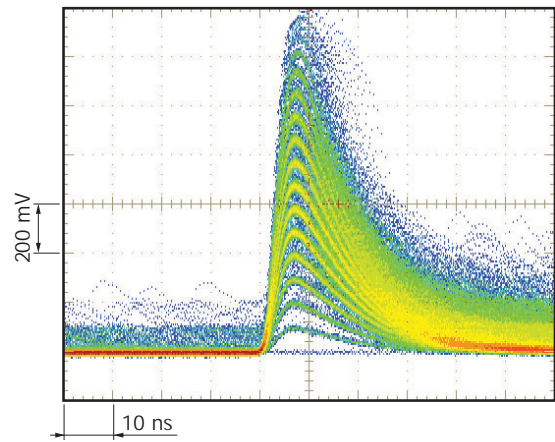

Analog output temperature characteristic

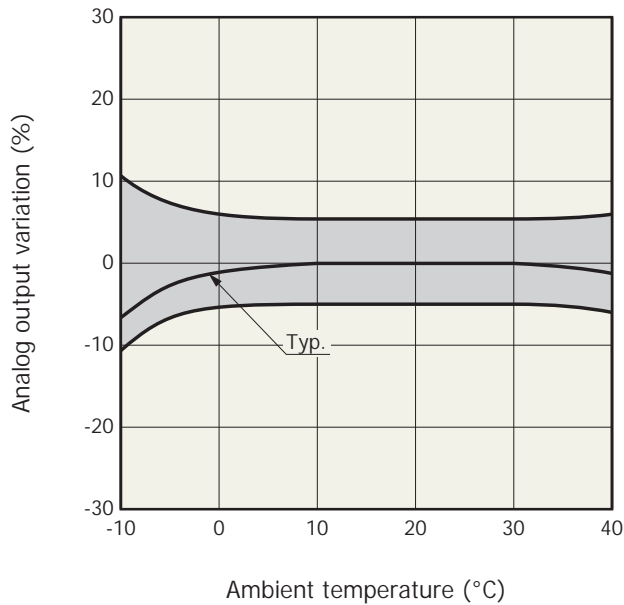

KACCB0175EA

Linearity (typical example)

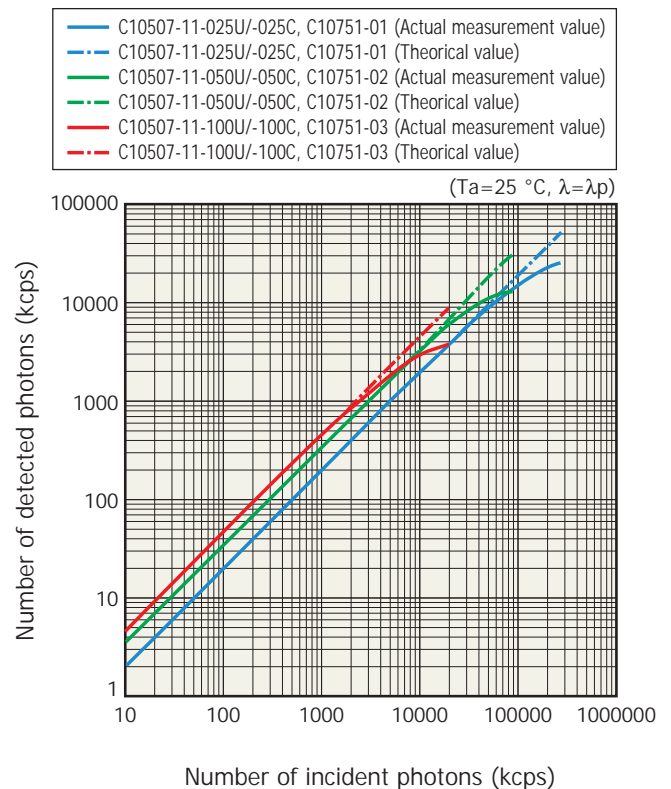

The MPPC module and a point light source, which face each other at a certain distance, are placed in darkness, and a calibration photodiode is installed in position very close the MPPC. The number of photons incident on the MPPC module is detected by the calibration photodiode and is then compared with the output count of the MPPC module in order to find the linearity.

KACCB0176EC

## Connection example

To use the MPPC module, it must be connected to a PC through a USB 1.1 interface. The MPPC is powered by the USB bus power from the PC. Various MPPC module operations are performed on the PC, and the measurement data can be monitored on the PC. Connecting the analog output to an oscilloscope allows monitoring the output waveforms. Connecting the comparator output to a frequency counter allows obtaining the count value.

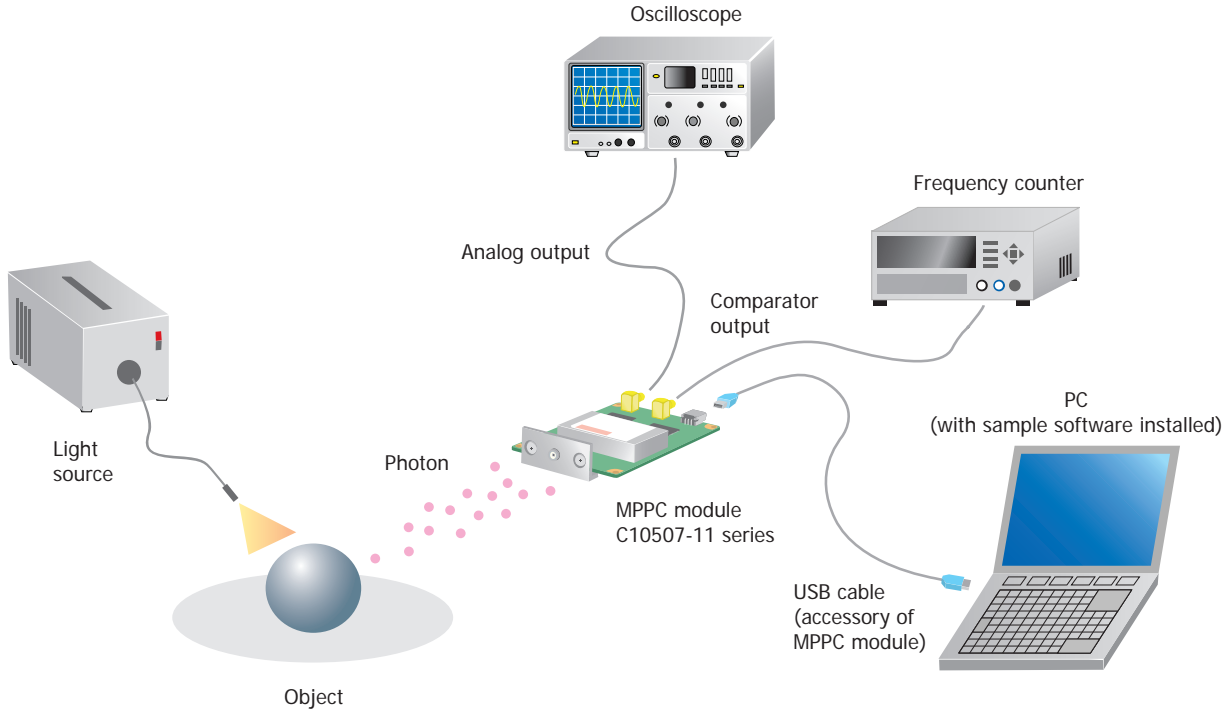

KACC00373EA

## Sample software (supplied)

The sample software is designed to easily perform basic MPPC module operations. Using the sample software makes it easy to perform measurements. Basic functions of the sample software are acquiring data, displaying measurement data graphs, and saving data.

### System requirements for sample software

The sample software operation is verified by the following systems. Operation with other systems is not guaranteed.

Microsoft® Windows® XP Professional SP3 (32-bit)\*6  
 Microsoft® Windows® Vista Business SP1, SP2 (32-bit)\*6  
 Microsoft® Windows® 7 Professional no SP, SP1 (32-bit/64-bit)\*6

We recommend using a PC with a high-performance CPU and a large capacity memory. A high-performance CPU and large memory are especially important when operating two or more MPPC modules simultaneously.

### Example of measuring very low level light

This graph shows an output change when very low level light is input in dark conditions.

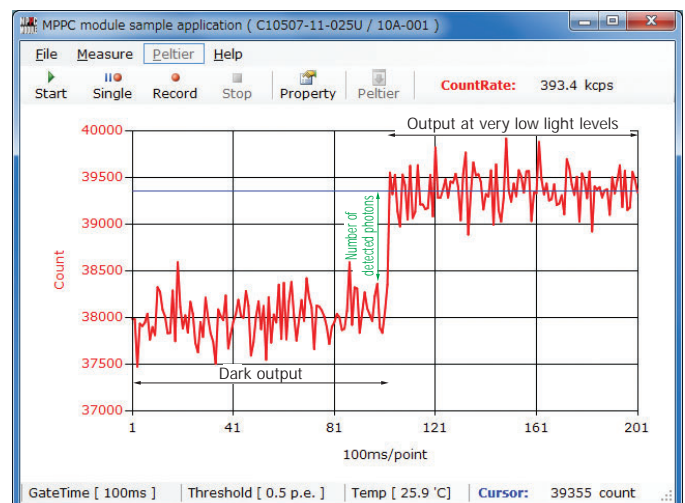

Vertical axis: Number of input counts per gate time setting  
 Horizontal axis: Time [1 second per scale division (10)]

\*6: Microsoft Windows is either registered trademarks or trademarks of Microsoft Corporation in the United States and/or other countries

Dimensional outlines (unit: mm, unless otherwise noted: ±0.3)

C10507-11-025U/-050U/-100U

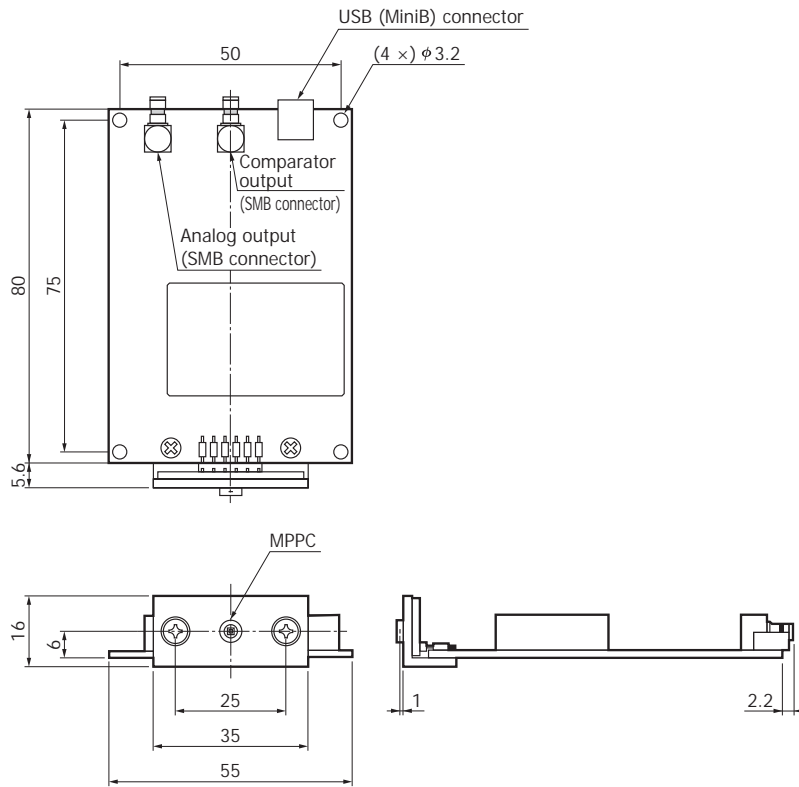

KACCA0210EC

C10507-11-025C/-050C/-100C

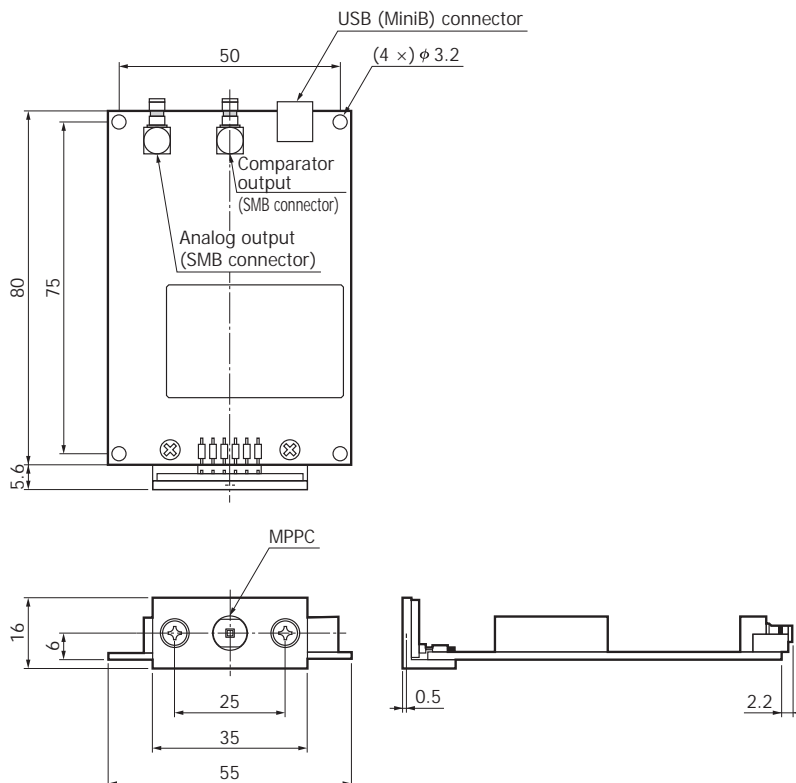

KACCA0233EB

## C10751 series

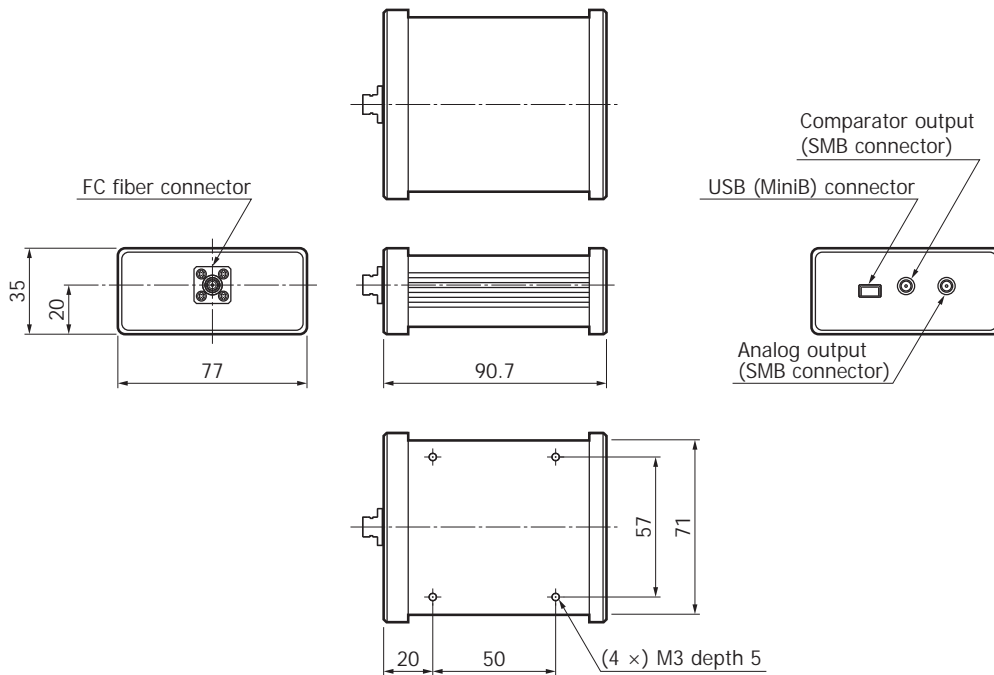

KACCA0230EB

### Accessories

- USB cable
- Quick start guide
- CD-ROM (Instruction manual, sample software)

### Handling precautions

- Do not use organic solvent such as thinner and acetone for cleaning. Use a soft dry cloth to wipe clean the surface of the MPPC module.
- Since the window of this product is made with soft resin, don't push nor touch the window surface by the hard or tip object. If the window needs to be cleaned, use ethyl alcohol and wipe off the window gently.
- For instructions on how to install the sample software to your PC, refer to the "Quick start guide" that comes with the MPPC module. When installing the sample software, make sure that the MPPC module is not connected to the PC. Otherwise, the software installation might fail.
- Power to this product is supplied from the USB port on the PC. Due to the USB specifications, the maximum power that can be supplied from one USB port is limited to 5 V, 500 mA. Avoid connecting two or more units to one USB port through a hub. Typical power consumption of the MPPC module is 200 mA.
- Depending on the PC model, the power supplied from the USB port might be interrupted when the power saving function or screensaver is activated. In this case, the MPPC module also stops operation and might create problems when the PC returns from power saving or screensaver mode. If USB power from your PC is interrupted in this same way, disable the power saving function and screensaver. For information on PC functions and settings, refer to the PC operation manual.

## Options

### Fiber adapter A10524 series

The A10524 series fiber adapters are designed to couple the MPPC module to an optical fiber. Two types are available for FC and SMA connectors. Using this adapter allows efficiently coupling the MPPC module to a GI-50/125 multi-mode fiber. This adapter screws on for easy attachment.

Note: Optical fiber is needed separately.



A10524-01 (FC type)



A10524-02 (SMA type)

■ Suitable MPPC module:

C10507-11-025U  
C10507-11-050U  
C10507-11-100U

### Coaxial converter adapter A10613 series

The A10613 series is a coaxial adapter that converts the SMB coaxial connector for signal-output on the MPPC module to a BNC or SMA coaxial connector. This adapter allows connecting a BNC or SMA cable to the MPPC module.



A10613-01 (SMB-BNC)



A10613-02 (SMB-SMA)

## Description of terms

### ☒ Analog output voltage

The MPPC module analog output is set so as to obtain a peak voltage of 100 mV at 1 p.e.

### ☒ Dark count

Output pulses are produced not only by photon-generated carriers but also by thermally-generated dark current carriers. The dark current pulses are measured as dark count which then causes detection errors. The dark count can be reduced by lowering the temperature. In the MPPC module, the count value measured at 0.5 p.e. is defined as the dark count.

### ☒ Photon detection efficiency: PDE

This is a measure of what percent of the incident photons were detected. Not all carriers generated by the incidence of photons will create pulses at an amplitude large enough to be detected, so photon detection efficiency is lower than quantum efficiency. In the MPPC module, the count value measured using a threshold of 0.5 p.e. is defined as the dark count.

### ☒ p.e. (photon equivalent)

This indicates that one photon was detected. For example, a 1 p.e. pulse is equivalent to the pulse (including noise components) obtained when one photon is detected.



### Lineup of MPPC module

Type no.	Internal MPPC					Spectral response range (nm)		
	Number of pixels	Pixel size (μm)	Package	Effective photosensitive area (mm)	Type no.			
Room temperature type	C10507-11-025U	1600	25 × 25	Metal	1 × 1	S10362-11-025U	320 to 900	
	C10507-11-050U	400	50 × 50			S10362-11-050U		
	C10507-11-100U	100	100 × 100			S10362-11-100U		
	C10507-11-025C	1600	25 × 25	Ceramic		S10362-11-025C		
	C10507-11-050C	400	50 × 50			S10362-11-050C		
	C10507-11-100C	100	100 × 100			S10362-11-100C		
	TE-cooled type	C10751-01	1600	25 × 25		Metal		S10362-11-025U
		C10751-02	400	50 × 50				S10362-11-050U
		C10751-03	100	100 × 100				S10362-11-100U
C11208-01		1600	25 × 25	S11028-025				
C11208-02		400	50 × 50	S11028-050				
C11208-03		100	100 × 100	S11028-100				

Note: The last letter of each type number indicates package materials (U: metal, C: ceramic).

C10507-11 series

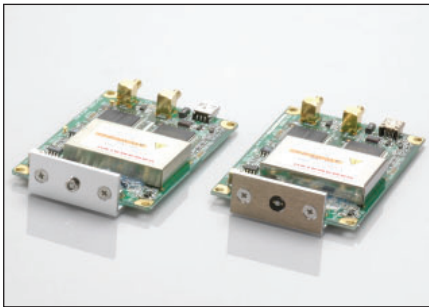

C10751 series



C11208 series



The C10751 series and C11208 series conform to the European EMC directives (Applied standard: EN 61326-1 Class B).

Information described in this material is current as of September, 2012.

Product specifications are subject to change without prior notice due to improvements or other reasons. Before assembly into final products, please contact us for the delivery specification sheet to check the latest information.

Type numbers of products listed in the delivery specification sheets or supplied as samples may have a suffix "(X)" which means preliminary specifications or a suffix "(Z)" which means developmental specifications.

The product warranty is valid for one year after delivery and is limited to product repair or replacement for defects discovered and reported to us within that one year period. However, even if within the warranty period we accept absolutely no liability for any loss caused by natural disasters or improper product use.

Copying or reprinting the contents described in this material in whole or in part is prohibited without our prior permission.

# HAMAMATSU

www.hamamatsu.com

HAMAMATSU PHOTONICS K.K., Solid State Division

1126-1 Ichino-cho, Higashi-ku, Hamamatsu City, 435-8558 Japan, Telephone: (81) 53-434-3311, Fax: (81) 53-434-5184

U.S.A.: Hamamatsu Corporation: 360 Foothill Road, P.O.Box 6910, Bridgewater, N.J. 08807-0910, U.S.A., Telephone: (1) 908-231-0960, Fax: (1) 908-231-1218

Germany: Hamamatsu Photonics Deutschland GmbH: Arzbergerstr. 10, D-82211 Herrsching am Ammersee, Germany, Telephone: (49) 8152-375-0, Fax: (49) 8152-265-8

France: Hamamatsu Photonics France S.A.R.L.: 19, Rue du Saule Trapu, Parc du Moulin de Massy, 91882 Massy Cedex, France, Telephone: 33-(1) 69 53 71 00, Fax: 33-(1) 69 53 71 10

United Kingdom: Hamamatsu Photonics UK Limited: 2 Howard Court, 10 Tewin Road, Welwyn Garden City, Hertfordshire AL7 1BW, United Kingdom, Telephone: (44) 1707-294888, Fax: (44) 1707-325777

North Europe: Hamamatsu Photonics Norden AB: Thorshamnsgatan 35 16440 Kista, Sweden, Telephone: (46) 8-509-031-00, Fax: (46) 8-509-031-01

Italy: Hamamatsu Photonics Italia S.R.L.: Strada della Moia, 1 int. 6, 20020 Arese, (Milano), Italy, Telephone: (39) 02-935-81-733, Fax: (39) 02-935-81-741

China: Hamamatsu Photonics (China) Co., Ltd.: 1201 Tower B, Jiaming Center, No.27 Dongsanhuan Beilu, Chaoyang District, Beijing 100020, China, Telephone: (86) 10-6586-6006, Fax: (86) 10-6586-2866