

Silicon PNP Power Transistors

2SB744 2SB744A

**DESCRIPTION**

With TO-126 package

- Complement to type 2SD794/794A
- Excellent  $h_{FE}$  linearity

**APPLICATIONS**

- For audio frequency power amplifier and general purpose applications

**PINNING**

PIN	DESCRIPTION
1	Emitter
2	Collector;connected to mounting base
3	Base

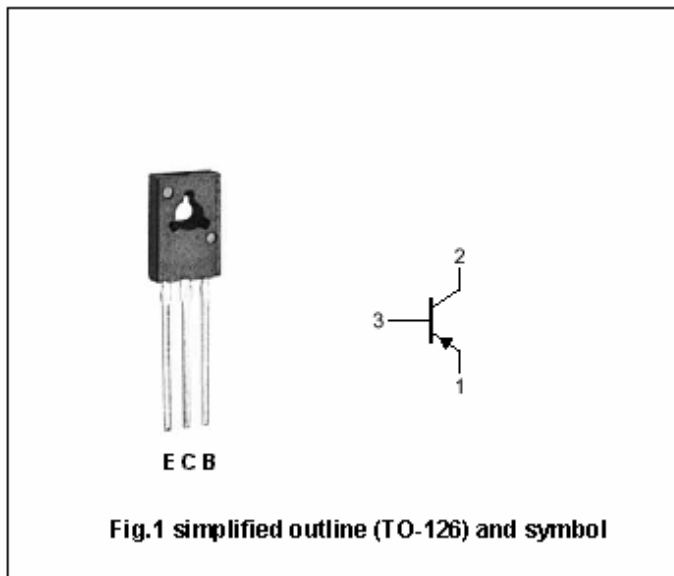

**Absolute maximum ratings( $T_a=25^\circ C$ )**

SYMBOL	PARAMETER	CONDITIONS	VALUE	UNIT
$V_{CBO}$	Collector-base voltage	Open emitter	-70	V
$V_{CEO}$	Collector-emitter voltage	2SB744	-45	V
		2SB744A	-60	
$V_{EBO}$	Emitter-base voltage	Open collector	-5	V
$I_C$	Collector current (DC)		-3	A
$I_{CM}$	Collector current-Peak		-5	A
$I_B$	Base current		-0.6	A
$P_C$	Collector power dissipation	$T_a=25^\circ C$	1	W
		$T_C=25^\circ C$	10	
$T_j$	Junction temperature		150	$^\circ C$
$T_{stg}$	Storage temperature		-55~150	$^\circ C$

## Silicon PNP Power Transistors

## 2SB744 2SB744A

## CHARACTERISTICS

T<sub>j</sub>=25°C unless otherwise specified

SYMBOL	PARAMETER		CONDITIONS	MIN	TYP.	MAX	UNIT
V <sub>(BR)CEO</sub>	Collector-emitter breakdown voltage	2SB744	I <sub>C</sub> =-10mA; I <sub>B</sub> =0	-45			V
		2SB744A		-60			
V <sub>CEsat</sub>	Collector-emitter saturation voltage		I <sub>C</sub> =-1.5A; I <sub>B</sub> =-0.15A		-0.5	-2.0	V
V <sub>BEsat</sub>	Base-emitter saturation voltage		I <sub>C</sub> =-1.5A; I <sub>B</sub> =-0.15A		-0.8	-2.0	V
I <sub>CBO</sub>	Collector cut-off current		V <sub>CB</sub> =-45V; I <sub>E</sub> =0			-1	μA
I <sub>EBO</sub>	Emitter cut-off current		V <sub>EB</sub> =-3V; I <sub>C</sub> =0			-1	μA
h <sub>FE-1</sub>	DC current gain		I <sub>C</sub> =-20mA; V <sub>CE</sub> =-5V	30	120		
h <sub>FE-2</sub>	DC current gain		I <sub>C</sub> =-0.5A; V <sub>CE</sub> =-5V	60	100	320	
f <sub>T</sub>	Transition frequency		I <sub>C</sub> =-0.1A; V <sub>CE</sub> =-5V		45		MHz
C <sub>OB</sub>	Collector output capacitance		f=1MHz; V <sub>CB</sub> =-10V; I <sub>E</sub> =0		60		pF

◆ h<sub>FE-2</sub> Classifications

R	O	Y
60-120	100-200	160-320

Silicon PNP Power Transistors

2SB744 2SB744A

PACKAGE OUTLINE

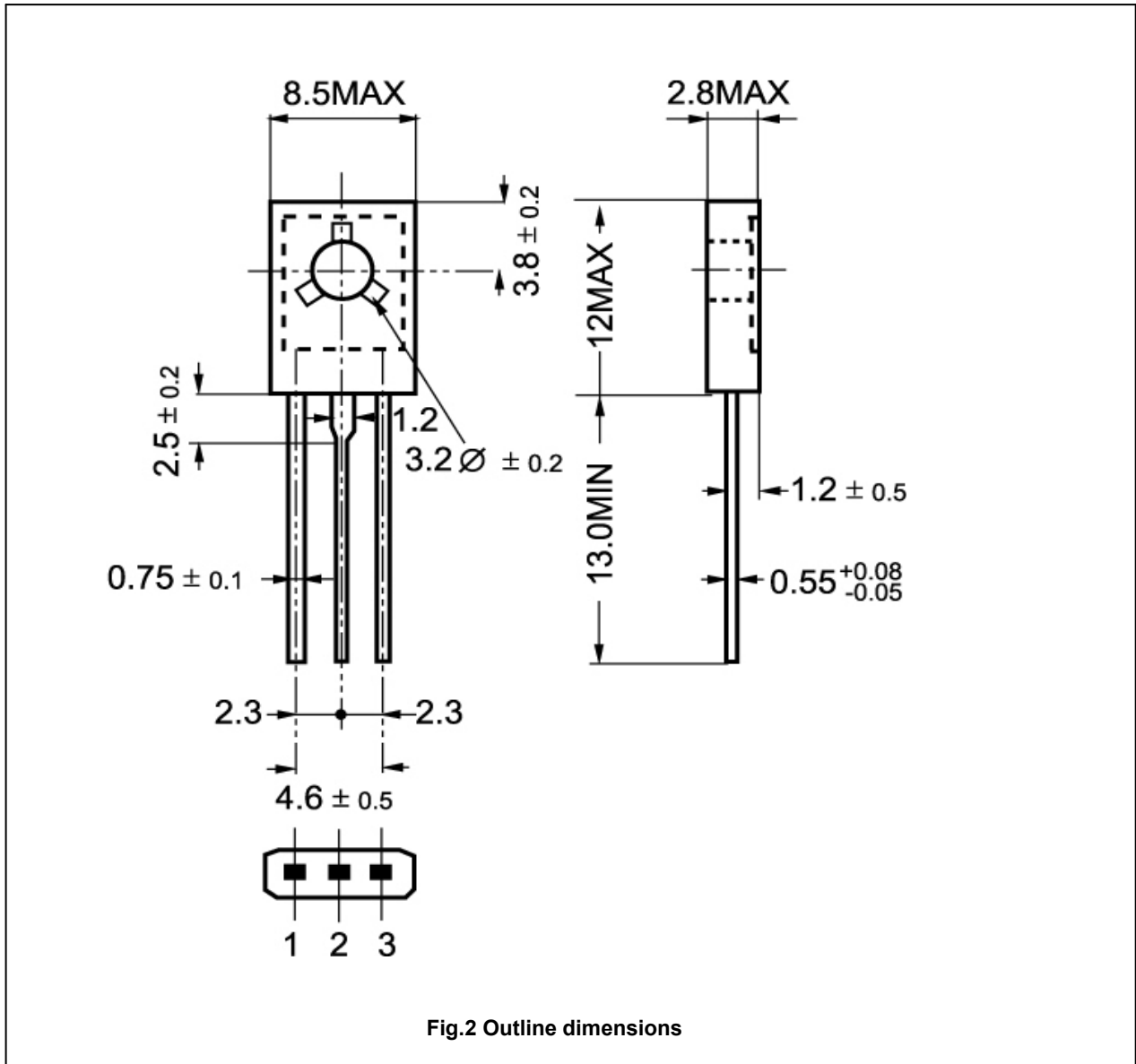

Silicon PNP Power Transistors

2SB744 2SB744A

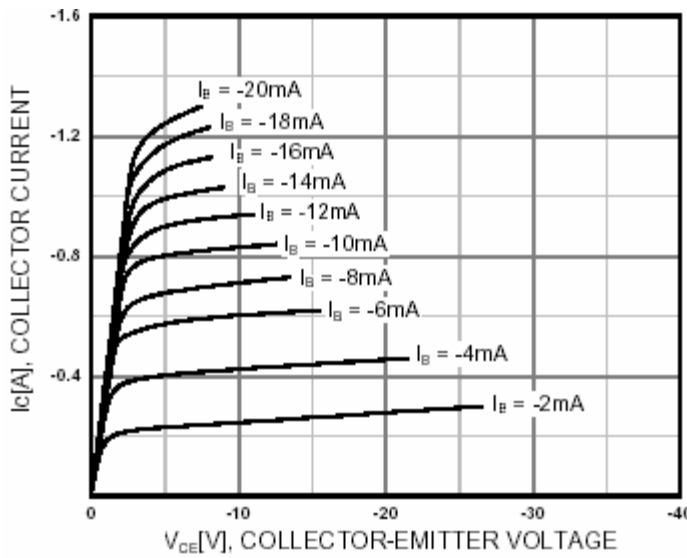

Fig.3 Static Characteristic

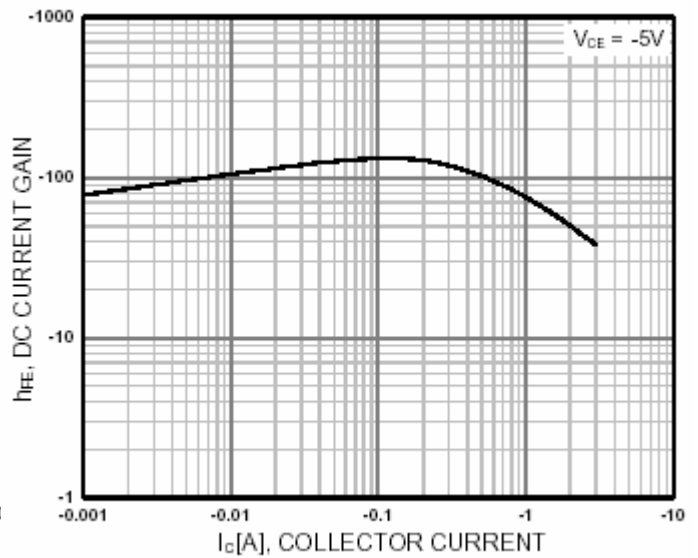

Fig.4 DC current Gain

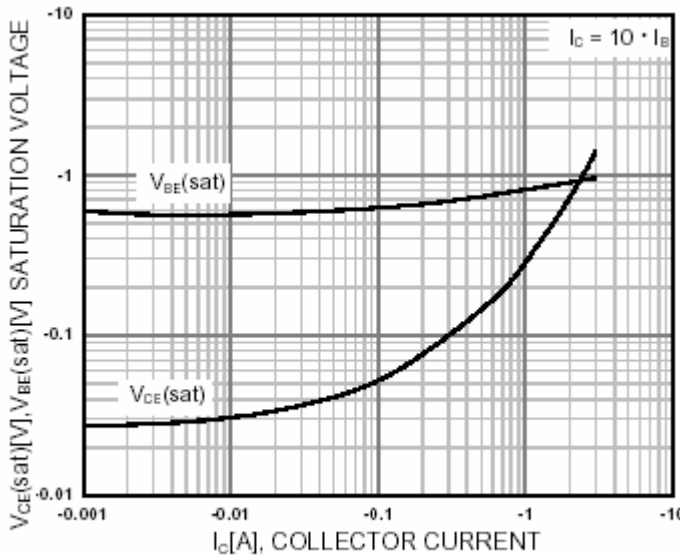

Fig.5 Base-Emitter Saturation Voltage  
Collector-Emitter Saturation Voltage

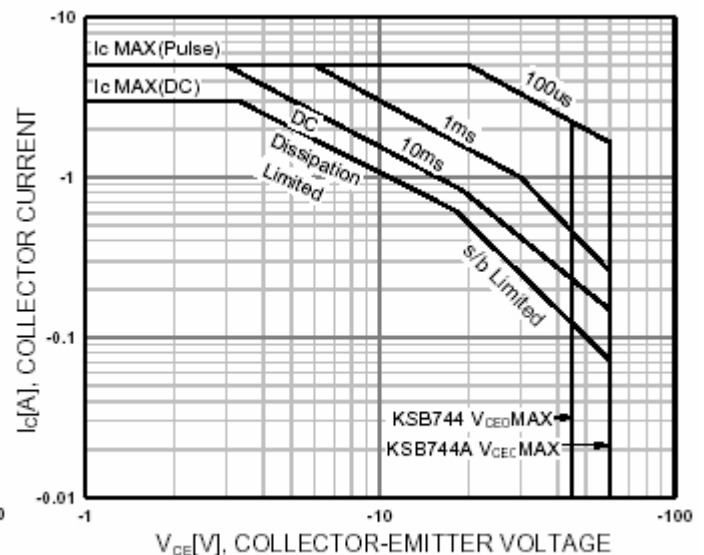

Fig.6 Safe Operating Area

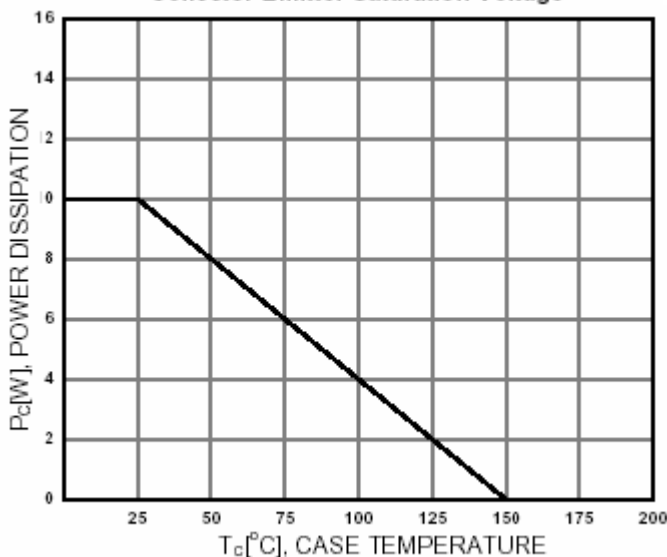

Fig.7 Power Derating