

isc Silicon PNP Darlington Power Transistor

2SB1556

DESCRIPTION

- Collector-Emitter Breakdown Voltage-
: $V_{(BR)CEO} = -140V(\text{Min})$
- High DC Current Gain-
: $h_{FE} = 5000(\text{Min}) @ I_C = -7A$
- Complement to Type 2SD2385

APPLICATIONS

- Designed for power amplifier applications

ABSOLUTE MAXIMUM RATINGS($T_a=25^\circ\text{C}$)

SYMBOL	PARAMETER	VALUE	UNIT
V_{CBO}	Collector-Base Voltage	-140	V
V_{CEO}	Collector-Emitter Voltage	-140	V
V_{EBO}	Emitter-Base Voltage	-5	V
I_C	Collector Current-Continuous	-8	A
I_B	Base Current-Continuous	-0.1	A
P_C	Collector Power Dissipation @ $T_C=25^\circ\text{C}$	120	W
T_J	Junction Temperature	150	$^\circ\text{C}$
T_{stg}	Storage Temperature Range	-55~150	$^\circ\text{C}$

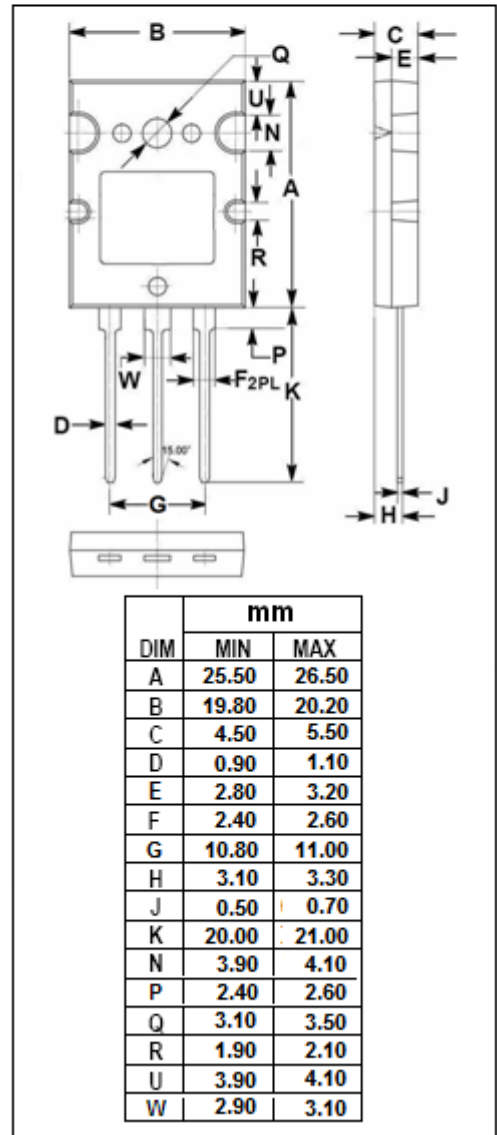
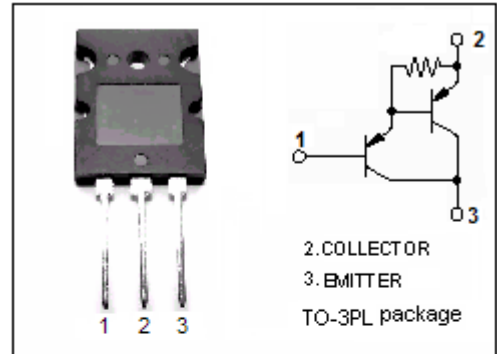

isc Silicon PNP Darlington Power Transistor**2SB1556****ELECTRICAL CHARACTERISTICS** $T_C=25^\circ\text{C}$ unless otherwise specified

SYMBOL	PARAMETER	CONDITIONS	MIN	TYP.	MAX	UNIT
$V_{(BR)CEO}$	Collector-Emitter Breakdown Voltage	$I_C = -50\text{mA}$; $I_B = 0$	-140			V
$V_{CE(sat)}$	Collector-Emitter Saturation Voltage	$I_C = -7\text{A}$; $I_B = -7\text{mA}$			-2.5	V
$V_{BE(on)}$	Base-Emitter On Voltage	$I_C = -7\text{A}$; $V_{CE} = -5\text{V}$			-3.0	V
I_{CBO}	Collector Cutoff Current	$V_{CB} = -140\text{V}$; $I_E = 0$			-5	μA
I_{EBO}	Emitter Cutoff Current	$V_{EB} = -5\text{V}$; $I_C = 0$			-5	μA
h_{FE-1}	DC Current Gain	$I_C = -7\text{A}$; $V_{CE} = -5\text{V}$	5000		30000	
h_{FE-2}	DC Current Gain	$I_C = -12\text{A}$; $V_{CE} = -5\text{V}$	2000			
C_{OB}	Output Capacitance	$I_E = 0$; $V_{CB} = -10\text{V}$; $f_{test} = 1.0\text{MHz}$		170		pF
f_T	Current-Gain—Bandwidth Product	$I_C = -1\text{A}$; $V_{CE} = -5\text{V}$		30		MHz

◆ **h_{FE-1} Classifications**

A	B	C
5000-12000	9000-18000	15000-30000