



128K × 8 HIGH SPEED CMOS STATIC RAM

GENERAL DESCRIPTION

The W24010AC is a high speed, low power CMOS static RAM organized as 131072 × 8 bits that operates on a single 5-volt power supply. This device is manufactured using Winbond's high performance CMOS technology, which can meet the industrial grade requirement.

FEATURES

- High speed access time: 12/15 nS (max.)
- Low power consumption:
 - Active: 600 mW (typ.)
- Single +5V power supply
- Fully static operation
- All inputs and outputs directly TTL compatible
- Three-state outputs
- Available packages: 32-pin 300 mil SOJ, 400 mil SOJ, skinny DIP and standard type one TSOP (8 mm × 20 mm)

PIN CONFIGURATIONS

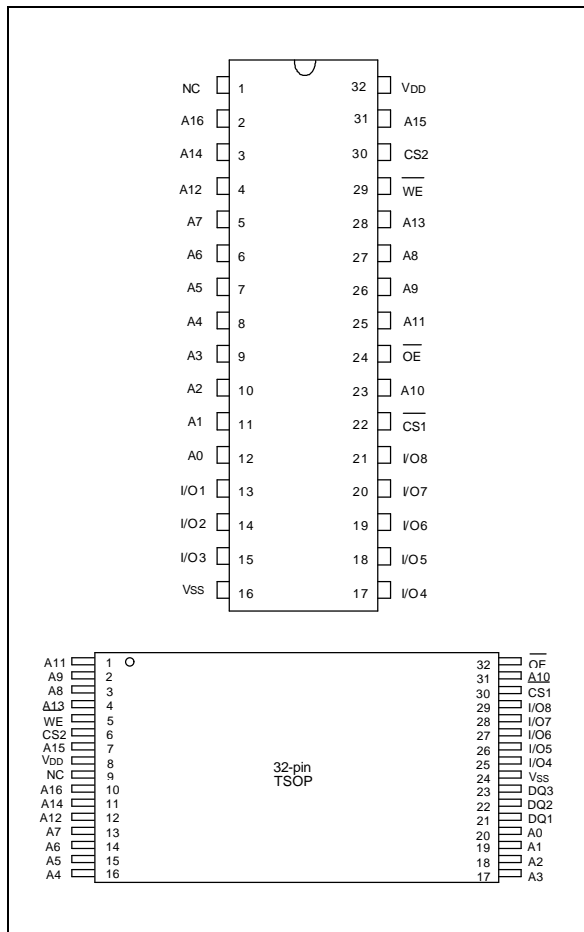

BLOCK DIAGRAM

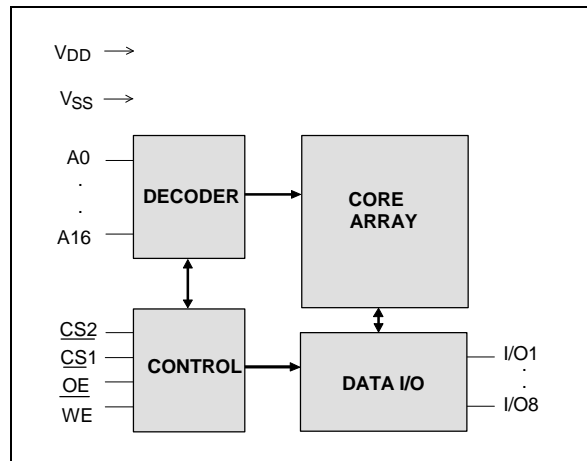

PIN DESCRIPTION

SYMBOL	DESCRIPTION
A0–A16	Address Inputs
I/O1–I/O8	Data Inputs/Outputs
CS1, CS2	Chip Select Inputs
WE	Write Enable Input
OE	Output Enable Input
VDD	Power Supply
VSS	Ground
NC	No Connection



TRUTH TABLE

$\overline{CS1}$	CS2	\overline{OE}	\overline{WE}	MODE	I/O1- I/O8	V _{DD} CURRENT
H	X	X	X	Not Selected	High Z	I _{SB} , I _{SB1}
X	L	X	X	Not Selected	High Z	I _{SB} , I _{SB1}
L	H	H	H	Output Disable	High Z	I _{DD}
L	H	L	H	Read	Data Out	I _{DD}
L	H	X	L	Write	Data In	I _{DD}

DC CHARACTERISTICS

Absolute Maximum Ratings

PARAMETER	RATING	UNIT
Supply Voltage to V _{SS} Potential	-0.5 to +7.0	V
Input/Output to V _{SS} Potential	-0.5 to V _{DD} +0.5	V
Allowable Power Dissipation	1.5	W
Storage Temperature	-65 to +150	°C
Operating Temperature	0 to +70	°C

Note: Exposure to conditions beyond those listed under Absolute Maximum Ratings may adversely affect the life and reliability of the device.

Operating Characteristics

(V_{DD} = 5V ±10%, V_{SS} = 0V, T_A = 0 to 70° C)

PARAMETER	SYM.	TEST CONDITIONS	MIN.	TYP.	MAX.	UNIT
Input Low Voltage	V _{IL}	-	-0.5	-	+0.8	V
Input High Voltage	V _{IH}	-	+2.2	-	V _{DD} +0.5	V
Input Leakage Current	I _{LI}	V _{IN} = V _{SS} to V _{DD}	-10	-	+10	μA
Output Leakage Current	I _{LO}	V _{I/O} = V _{SS} to V _{DD} $\overline{CS1}$ = V _{IH} (min.) or CS2 = V _{IL} (max.) or \overline{OE} = V _{IH} (min.) or \overline{WE} = V _{IL} (max.)	-10	-	+10	μA
Output Low Voltage	V _{OL}	I _{OL} = +8.0 mA	-	-	0.4	V
Output High Voltage	V _{OH}	I _{OH} = -4.0 mA	2.4	-	-	V
Operating Power Supply Current	I _{DD}	$\overline{CS1}$ = V _{IL} (max.), CS2 = V _{IH} (min.) I/O = 0 mA, C _{ycle} = min. Duty = 100%	-	-	200	mA
Standby Power Supply Current	I _{SB}	$\overline{CS1}$ = V _{IH} (min.), or CS2 = V _{IL} (max.)	-	-	30	mA
	I _{SB1}	CS1 ≥ V _{DD} -0.2V or CS2 ≤ 0.2V	-	-	10	mA

Note: Typical characteristics are at V_{DD} = 5V, T_A = 25° C.

CAPACITANCE

(V_{DD} = 5V, T_A = 25° C, f = 1 MHz)

PARAMETER	SYM.	CONDITIONS	MAX.	UNIT
Input Capacitance	C _{IN}	V _{IN} = 0V	8	pF
Input/Output Capacitance	C _{I/O}	V _{OUT} = 0V	10	pF

Note: These parameters are sampled but not 100% tested.

AC CHARACTERISTICS

AC Test Conditions

PARAMETER	CONDITIONS
Input Pulse Levels	0V to 3V
Input Rise and Fall Times	5 nS
Input and Output Timing Reference Level	1.5V
Output Load	C _L = 30 pF, I _{OH} /I _{OL} = -4 mA/8 mA

AC Test Loads and Waveform

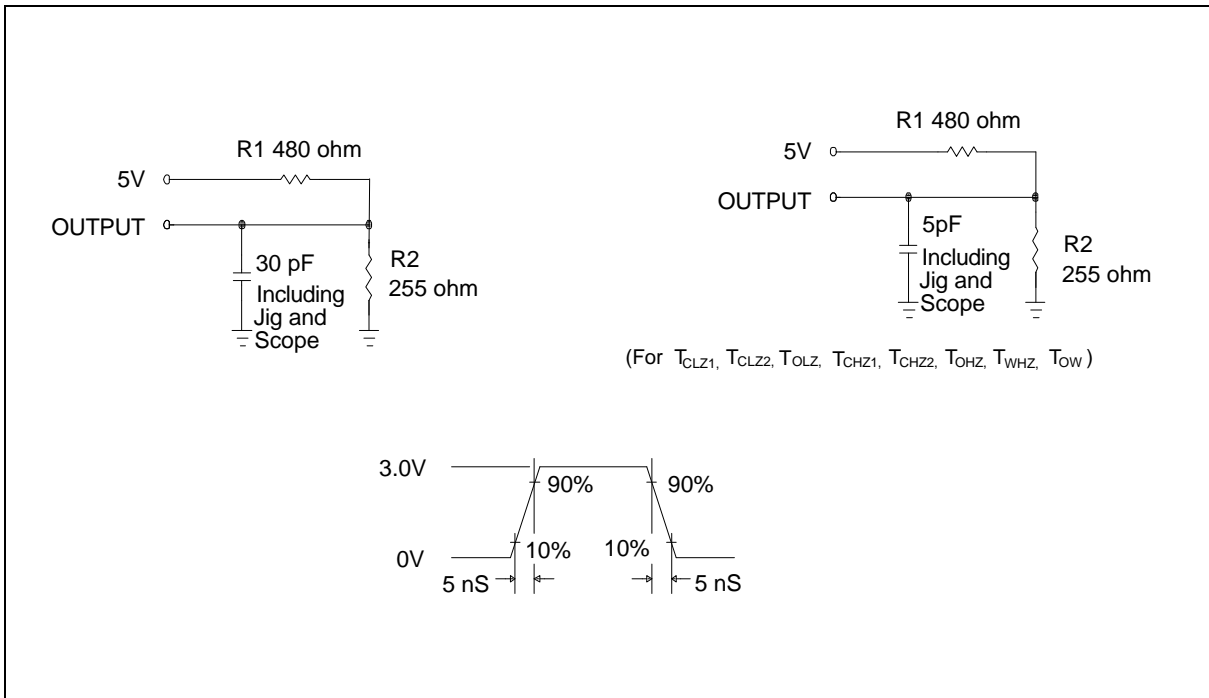



AC Characteristics, continued

(V_{DD} = 5V ±10%, V_{SS} = 0V, T_A = 0 to 70° C)

Read Cycle

PARAMETER		SYM.	W24010AC-12		W24010AC-15		UNIT
			MIN.	MAX.	MIN.	MAX.	
Read Cycle Time		TRC	12	-	15	-	nS
Address Access Time		TAA	-	12	-	15	nS
Chip Select Access Time	$\overline{\text{CS1}}$	TACS1	-	12	-	15	nS
	CS2	TACS2	-	12	-	15	nS
Output Enable to Output Valid		TAOE	-	6	-	7	nS
Chip Selection to Output in Low Z	$\overline{\text{CS1}}$	TCLZ1*	3	-	3	-	nS
	CS2	TCLZ2*	3	-	3	-	nS
Output Enable to Output in Low Z		TO LZ*	0	-	0	-	nS
Chip Deselection to Output in High Z	$\overline{\text{CS1}}$	TCHZ1*	-	6	-	7	nS
	CS2	TCHZ2*	-	6	-	7	nS
Output Disable to Output in High Z		TOHZ*	-	6	-	7	nS
Output Hold from Address Change		TOH	3	-	3	-	nS

* These parameters are sampled but not 100% tested.

Write Cycle

PARAMETER		SYM.	W24010AC-12		W24010AC-15		UNIT
			MIN.	MAX.	MIN.	MAX.	
Write Cycle Time		TWC	12	-	15	-	nS
Chip Selection to End of Write	$\overline{\text{CS1}}$	TCW1	10	-	13	-	nS
	CS2	TCW2	10	-	13	-	nS
Address Valid to End of Write		TAW	10	-	13	-	nS
Address Setup Time		TAS	0	-	0	-	nS
Write Pulse Width		TWP	10	-	10	-	nS
Write Recovery Time	$\overline{\text{CS1}}, \overline{\text{WE}}$	TWR1	0	-	0	-	nS
	CS2	TWR2	0	-	0	-	nS
Data Valid to End of Write		TDW	7	-	9	-	nS
Data Hold from End of Write		TDH	0	-	0	-	nS
Write to Output in High Z		TWHZ*	-	7	-	8	nS
Output Disable to Output in High Z		TOHZ*	-	7	-	8	nS
Output Active from End of Write		TOW	0	-	0	-	nS

* These parameters are sampled but not 100% tested.



TIMING WAVEFORMS

Read Cycle 1

(Address Controlled)

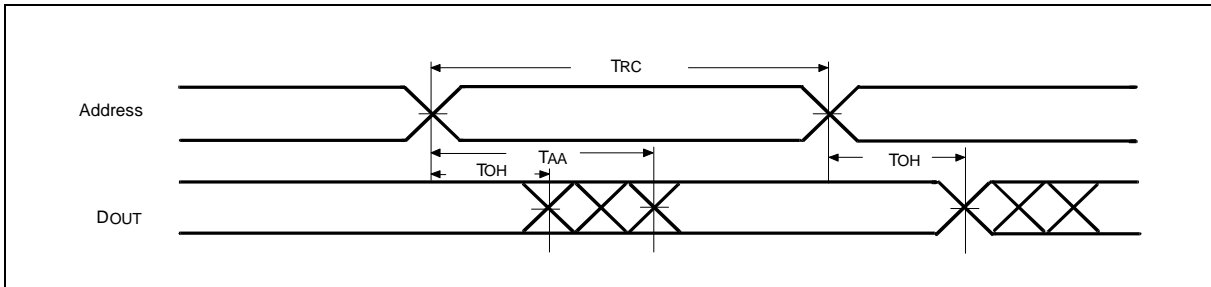

Read Cycle 2

(Chip Select Controlled)

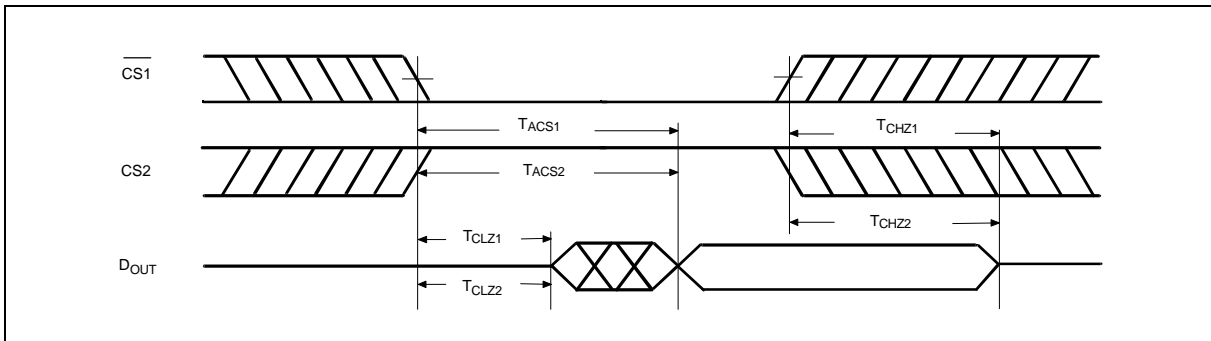

Read Cycle 3

(Output Enable Controlled)

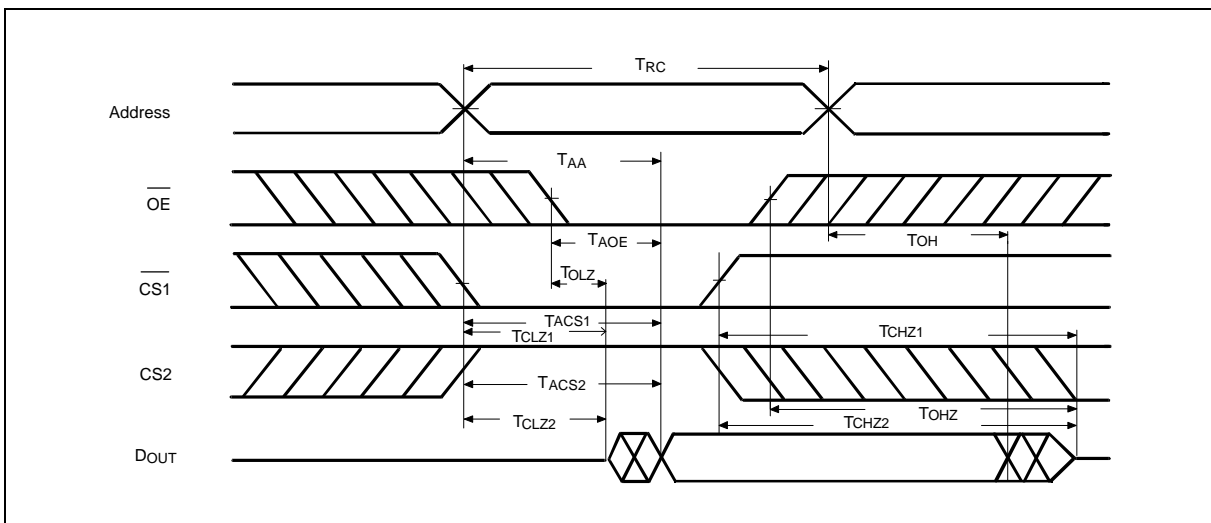



Timing Waveforms, continued

Write Cycle 1

(\overline{OE} Clock)

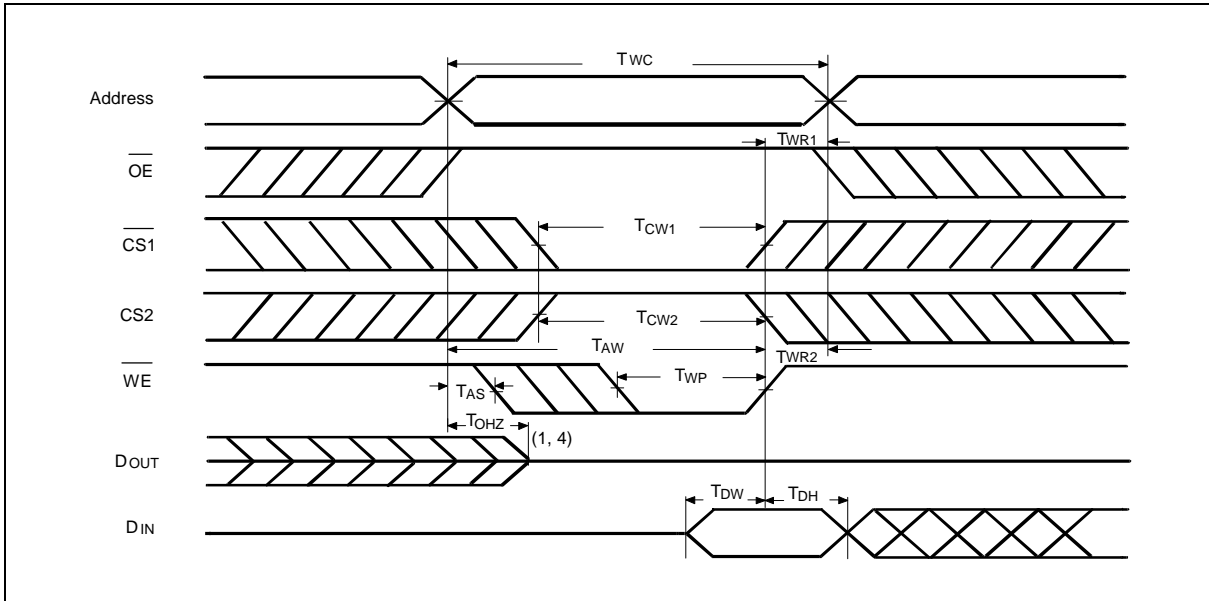

Write Cycle 2

($\overline{OE} = V_{IL}$ Fixed)

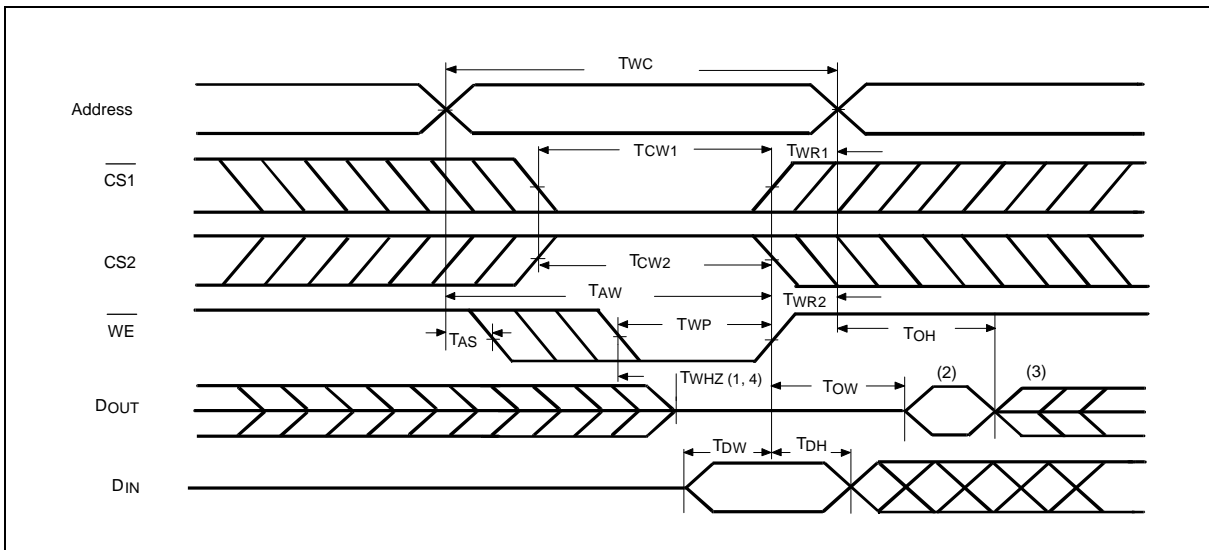

Notes:

1. During this period, I/O pins are in the output state, so input signals of opposite phase to the outputs should not be applied.
2. The data output from DOUT are the same as the data written to DIN during the write cycle.
3. DOUT provides the read data for the next address.
4. Transition is measured ± 500 mV from steady state with $C_L = 5$ pF. This parameter is guaranteed but not 100% tested.



ORDERING INFORMATION

PART NO.	ACCESS TIME (nS)	OPERATING CURRENT MAX. (mA)	STANDBY CURRENT MAX. (mA)	PACKAGE
W24010ACK-12	12	200	10	300 mil skinny DIP
W24010ACK-15	15	200	10	300 mil skinny DIP
W24010ACJ-12	12	200	10	300 mil SOJ
W24010ACJ-15	15	200	10	300 mil SOJ
W24010ACI-12	12	200	10	400 mil SOJ
W24010ACI-15	15	200	10	400 mil SOJ
W24010ACT-12	12	200	10	Standard type one TSOP
W24010ACT-15	15	200	10	Standard type one TSOP

Notes:

1. Winbond reserves the right to make changes to its products without prior notice.
2. Purchasers are responsible for performing appropriate quality assurance testing on products intended for use in applications where personal injury might occur as a consequence of product failure.

PACKAGE DIMENSIONS

32-pin P-DIP Skinny (300 mil)

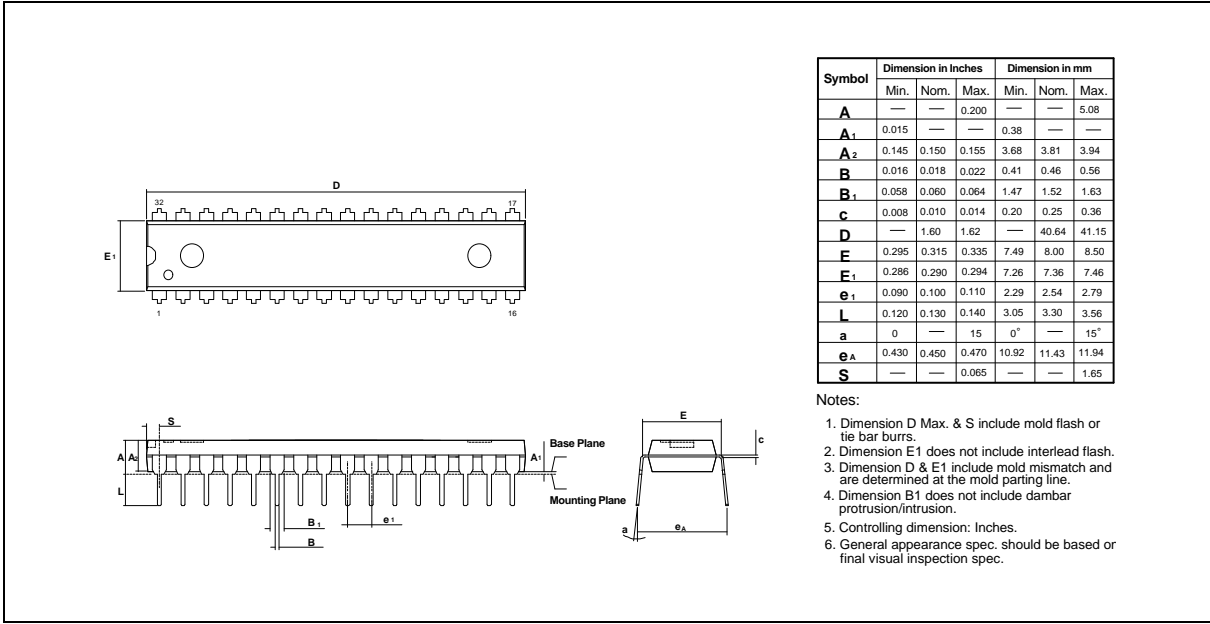

32-pin SOJ (300 mil)

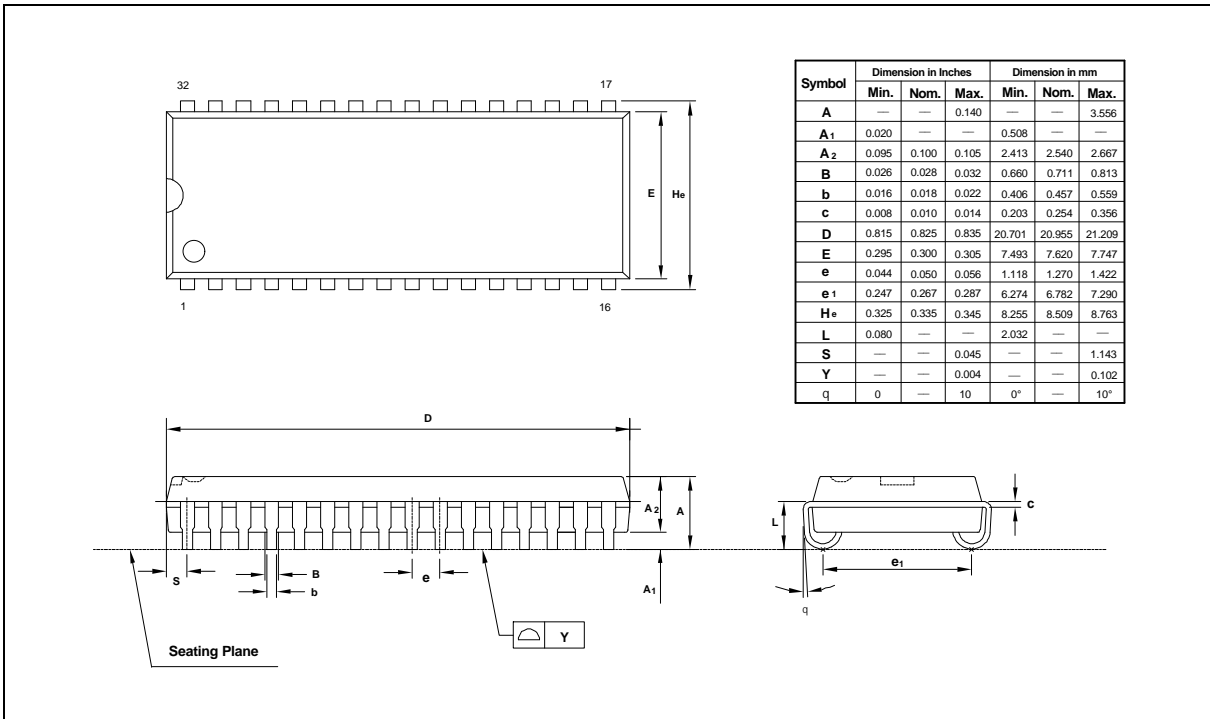

Package Dimensions, continued

32-pin SOJ (400 mil)

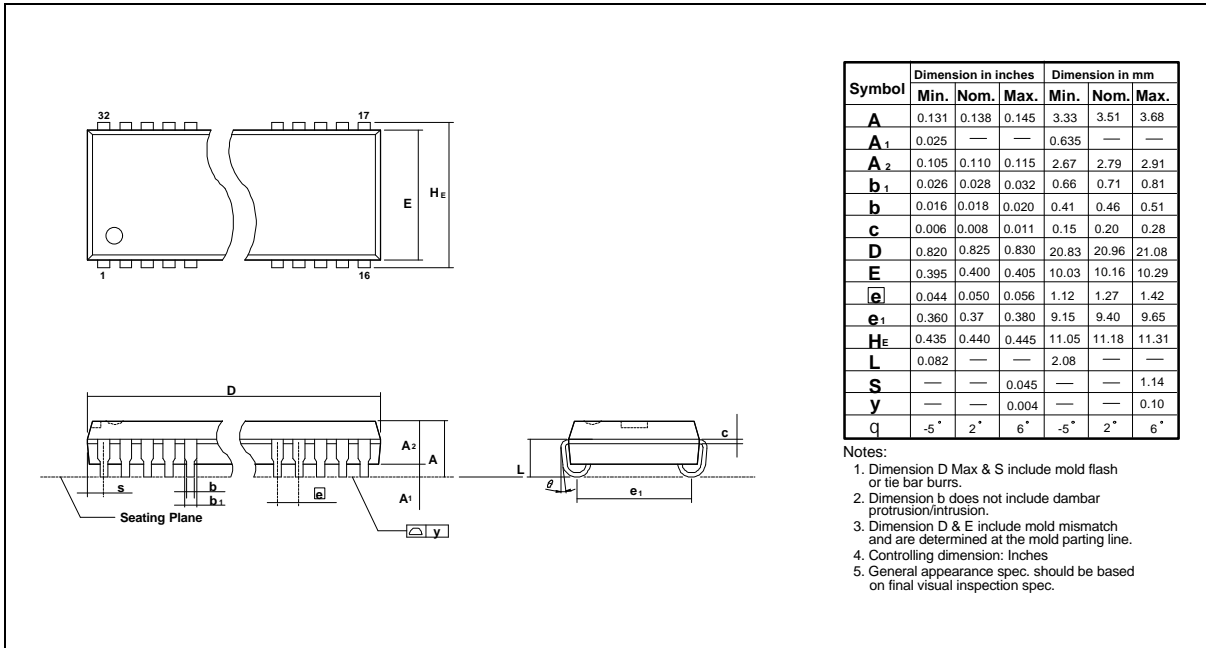

32-pin Standard Type One TSOP

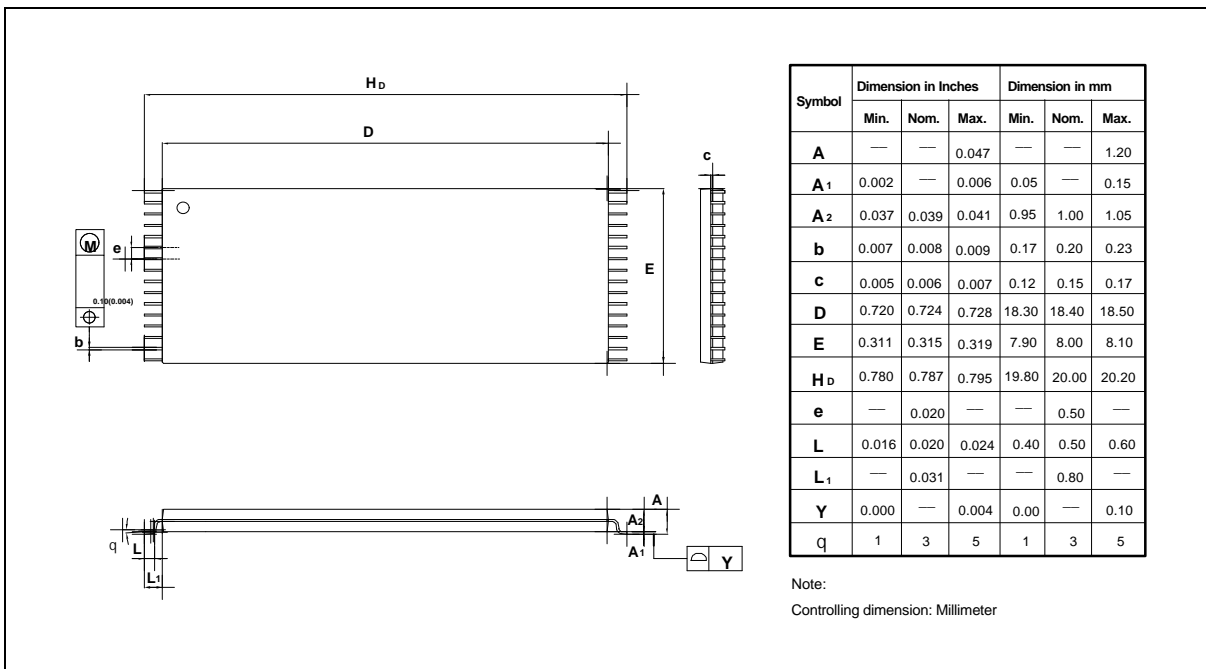



VERSION HISTORY

VERSION	DATE	PAGE	DESCRIPTION
A1	Nov. 1998	-	Initial Issued



Headquarters

No. 4, Creation Rd. III,
Science-Based Industrial Park,
Hsinchu, Taiwan
TEL: 886-3-5770066
FAX: 886-3-5792647
<http://www.winbond.com.tw/>
Voice & Fax-on-demand: 886-2-7197006

Taipei Office

11F, No. 115, Sec. 3, Min-Sheng East Rd.,
Taipei, Taiwan
TEL: 886-2-7190505
FAX: 886-2-7197502

Winbond Electronics (H.K.) Ltd.

Rm. 803, World Trade Square, Tower II,
123 Hoi Bun Rd., Kwun Tong,
Kowloon, Hong Kong
TEL: 852-27513100
FAX: 852-27552064

Winbond Electronics North America Corp.

Winbond Memory Lab.
Winbond Microelectronics Corp.
Winbond Systems Lab.
2730 Orchard Parkway, San Jose,
CA 95134, U.S.A.
TEL: 1-408-9436666
FAX: 1-408-9436668

Note: All data and specifications are subject to change without notice.