

FDMS8820

N-Channel PowerTrench® MOSFET 30 V, 116 A, 2.0 mΩ

Features

- Max $r_{DS(on)}$ = 2.0 mΩ at $V_{GS} = 10\text{ V}$, $I_D = 28\text{ A}$
- Max $r_{DS(on)}$ = 2.4 mΩ at $V_{GS} = 4.5\text{ V}$, $I_D = 25\text{ A}$
- Advanced Package and Silicon combination for low $r_{DS(on)}$ and high efficiency
- Next generation enhanced body diode technology, engineered for soft recovery
- MSL1 robust package design
- 100% UIL tested
- RoHS Compliant



General Description

This N-Channel MOSFET has been designed specifically to improve the overall efficiency and to minimize switch node ringing of DC/DC converters using either synchronous or conventional switching PWM controllers. It has been optimized for low gate charge, low $r_{DS(on)}$, fast switching speed and body diode reverse recovery performance.

Applications

- VRM Vcore Switching for Desktop and Server
- OringFET / Load Switching
- DC-DC Conversion

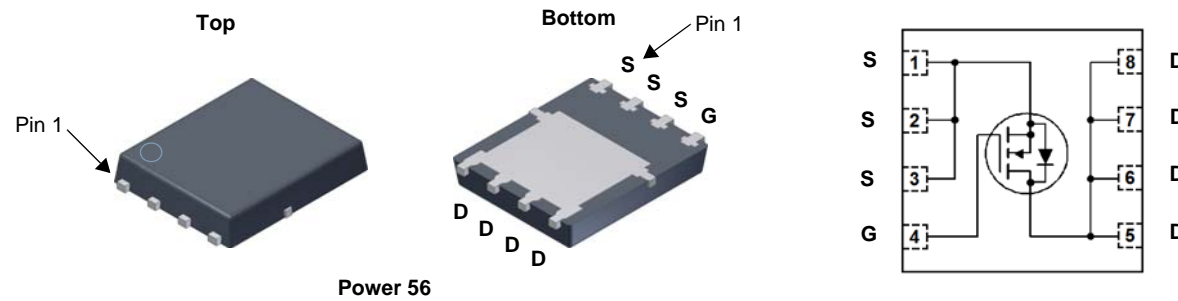

MOSFET Maximum Ratings $T_A = 25\text{ °C}$ unless otherwise noted

| Symbol | Parameter | Ratings | Units |
|----------------|--|-------------|-------|
| V_{DS} | Drain to Source Voltage | 30 | V |
| V_{GS} | Gate to Source Voltage (Note 4) | ± 20 | V |
| I_D | Drain Current -Continuous $T_C = 25\text{ °C}$ | 116 | A |
| | -Continuous $T_A = 25\text{ °C}$ (Note 1a) | 28 | |
| | -Pulsed (Note 5) | 180 | |
| E_{AS} | Single Pulse Avalanche Energy (Note 3) | 294 | mJ |
| P_D | Power Dissipation $T_C = 25\text{ °C}$ | 78 | W |
| | Power Dissipation $T_A = 25\text{ °C}$ (Note 1a) | 2.5 | |
| T_J, T_{STG} | Operating and Storage Junction Temperature Range | -55 to +150 | °C |

Thermal Characteristics

| | | | |
|-----------------|---|-----|------|
| $R_{\theta JC}$ | Thermal Resistance, Junction to Case | 1.6 | °C/W |
| $R_{\theta JA}$ | Thermal Resistance, Junction to Ambient (Note 1a) | 50 | |

Package Marking and Ordering Information

| Device Marking | Device | Package | Reel Size | Tape Width | Quantity |
|----------------|----------|----------|-----------|------------|------------|
| FDMS8820 | FDMS8820 | Power 56 | 13" | 12 mm | 3000 units |

Electrical Characteristics $T_J = 25^\circ\text{C}$ unless otherwise noted

| Symbol | Parameter | Test Conditions | Min | Typ | Max | Units |
|--------|-----------|-----------------|-----|-----|-----|-------|
|--------|-----------|-----------------|-----|-----|-----|-------|

Off Characteristics

| | | | | | | |
|--------------------------------------|---|---|----|----|-----|---------------|
| BV_{DSS} | Drain to Source Breakdown Voltage | $I_D = 250\ \mu\text{A}, V_{GS} = 0\ \text{V}$ | 30 | | | V |
| $\frac{\Delta BV_{DSS}}{\Delta T_J}$ | Breakdown Voltage Temperature Coefficient | $I_D = 250\ \mu\text{A}$, referenced to 25°C | | 19 | | mV/°C |
| I_{DSS} | Zero Gate Voltage Drain Current | $V_{DS} = 24\ \text{V}, V_{GS} = 0\ \text{V}$ | | | 1 | μA |
| I_{GSS} | Gate to Source Leakage Current, Forward | $V_{GS} = 20\ \text{V}, V_{DS} = 0\ \text{V}$ | | | 100 | nA |

On Characteristics

| | | | | | | |
|--|--|--|-----|-----|-----|------------|
| $V_{GS(th)}$ | Gate to Source Threshold Voltage | $V_{GS} = V_{DS}, I_D = 250\ \mu\text{A}$ | 1.2 | 1.5 | 2.5 | V |
| $\frac{\Delta V_{GS(th)}}{\Delta T_J}$ | Gate to Source Threshold Voltage Temperature Coefficient | $I_D = 250\ \mu\text{A}$, referenced to 25°C | | -6 | | mV/°C |
| $r_{DS(on)}$ | Static Drain to Source On Resistance | $V_{GS} = 10\ \text{V}, I_D = 28\ \text{A}$ | | 1.4 | 2.0 | m Ω |
| | | $V_{GS} = 4.5\ \text{V}, I_D = 25\ \text{A}$ | | 1.8 | 2.4 | |
| | | $V_{GS} = 10\ \text{V}, I_D = 28\ \text{A}, T_J = 125^\circ\text{C}$ | | 2.0 | 2.8 | |
| g_{FS} | Forward Transconductance | $V_{DS} = 5\ \text{V}, I_D = 28\ \text{A}$ | | 76 | | S |

Dynamic Characteristics

| | | | | | | |
|-----------|------------------------------|---|-----|------|------|----|
| C_{iss} | Input Capacitance | $V_{DS} = 15\ \text{V}, V_{GS} = 0\ \text{V},$ $f = 1\ \text{MHz}$ | | 3995 | 5315 | pF |
| C_{oss} | Output Capacitance | | | 1295 | 1725 | |
| C_{rss} | Reverse Transfer Capacitance | | | 177 | 270 | |
| R_g | Gate Resistance | | 0.1 | 1.1 | 2.5 | |

Switching Characteristics

| | | | | | | |
|--------------|-------------------------------|--|--|-----|----|----|
| $t_{d(on)}$ | Turn-On Delay Time | $V_{DD} = 15\ \text{V}, I_D = 28\ \text{A},$ $V_{GS} = 10\ \text{V}, R_{GEN} = 6\ \Omega$ | | 14 | 25 | ns |
| t_r | Rise Time | | | 7.7 | 16 | |
| $t_{d(off)}$ | Turn-Off Delay Time | | | 41 | 66 | |
| t_f | Fall Time | | | 6.4 | 13 | |
| Q_g | Total Gate Charge | | $V_{GS} = 0\ \text{V}$ to $10\ \text{V}$ | | 63 | |
| Q_g | Total Gate Charge | $V_{GS} = 0\ \text{V}$ to $4.5\ \text{V}$ | | 30 | 42 | |
| Q_{gs} | Gate to Source Charge | $V_{DD} = 15\ \text{V},$ $I_D = 28\ \text{A}$ | | 9.8 | | |
| Q_{gd} | Gate to Drain "Miller" Charge | | | 8.2 | | |

Drain-Source Diode Characteristics

| | | | | | | |
|----------|---------------------------------------|---|--|-----|-----|----|
| V_{SD} | Source to Drain Diode Forward Voltage | $V_{GS} = 0\ \text{V}, I_S = 2.0\ \text{A}$ (Note 2) | | 0.7 | 1.1 | V |
| | | $V_{GS} = 0\ \text{V}, I_S = 28\ \text{A}$ (Note 2) | | 0.8 | 1.2 | |
| t_{rr} | Reverse Recovery Time | $I_F = 28\ \text{A}, di/dt = 100\ \text{A}/\mu\text{s}$ | | 43 | 69 | ns |
| Q_{rr} | Reverse Recovery Charge | | | 27 | 43 | |

Notes:

1. $R_{\theta JA}$ is determined with the device mounted on a $1\ \text{in}^2$ pad 2 oz copper pad on a $1.5 \times 1.5\ \text{in.}$ board of FR-4 material. $R_{\theta JC}$ is guaranteed by design while $R_{\theta CA}$ is determined by the user's board design.

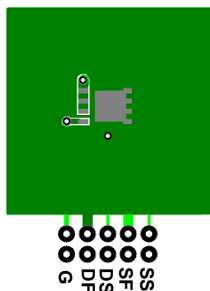

a. $50^\circ\text{C}/\text{W}$ when mounted on a $1\ \text{in}^2$ pad of 2 oz copper

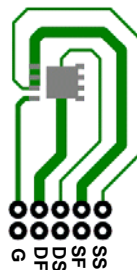

b. $125^\circ\text{C}/\text{W}$ when mounted on a minimum pad of 2 oz copper.

2. Pulse Test: Pulse Width $< 300\ \mu\text{s}$, Duty cycle $< 2.0\%$.

3. E_{AS} of 294 mJ is based on starting $T_J = 25^\circ\text{C}$; N-ch: $L = 3\ \text{mH}, I_{AS} = 14\ \text{A}, V_{DD} = 30\ \text{V}, V_{GS} = 10\ \text{V}$. 100% test at $L = 0.1\ \text{mH}, I_{AS} = 45\ \text{A}$.

4. As an N-ch device, the negative V_{GS} rating is for low duty cycle pulse occurrence only. No continuous rating is implied.

5. Pulsed I_d limited by junction temperature, $t_d \leq 100\ \mu\text{s}$, please refer to SOA curve for more details.

Typical Characteristics $T_J = 25\text{ }^\circ\text{C}$ unless otherwise noted

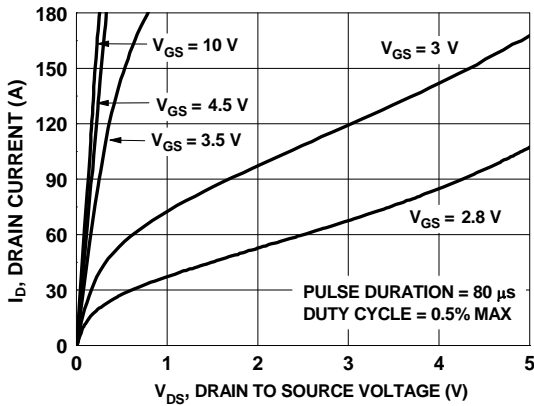

Figure 1. On Region Characteristics

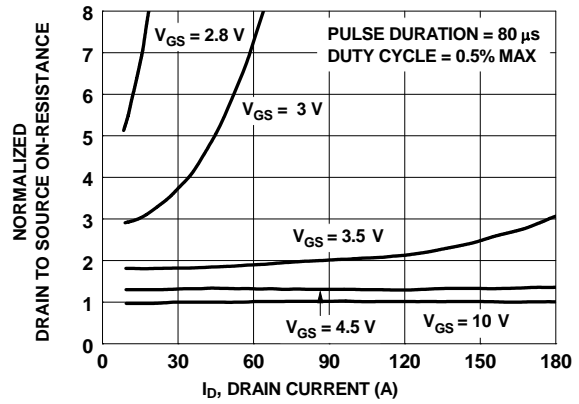

Figure 2. Normalized On-Resistance vs Drain Current and Gate Voltage

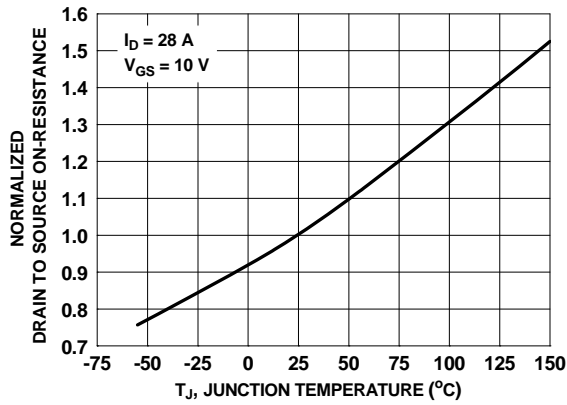

Figure 3. Normalized On Resistance vs Junction Temperature

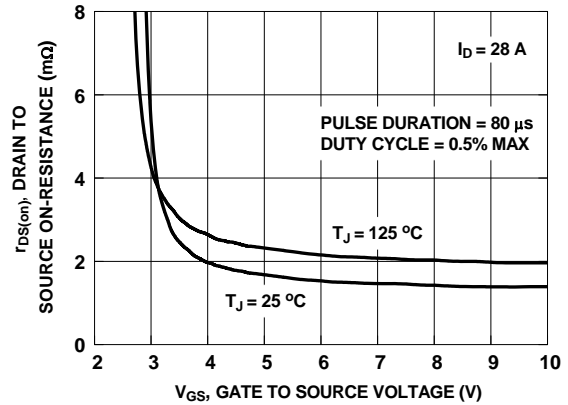

Figure 4. On-Resistance vs Gate to Source Voltage

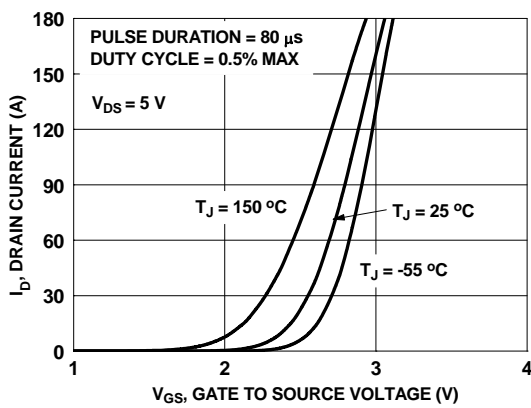

Figure 5. Transfer Characteristics

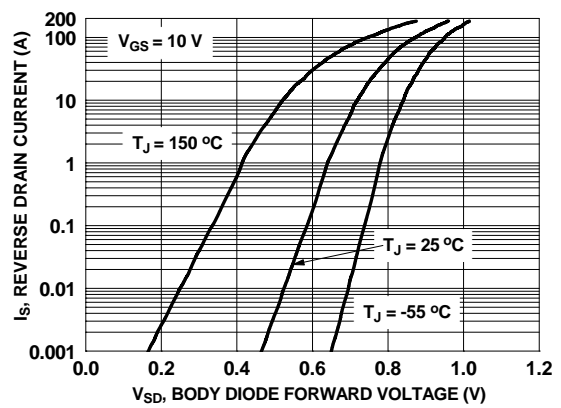

Figure 6. Source to Drain Diode Forward Voltage vs Source Current

Typical Characteristics $T_J = 25\text{ }^\circ\text{C}$ unless otherwise noted

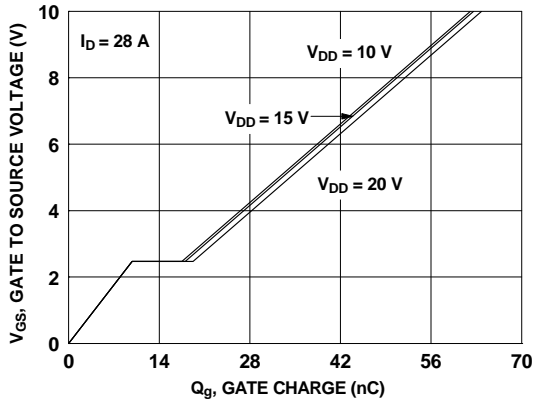

Figure 7. Gate Charge Characteristics

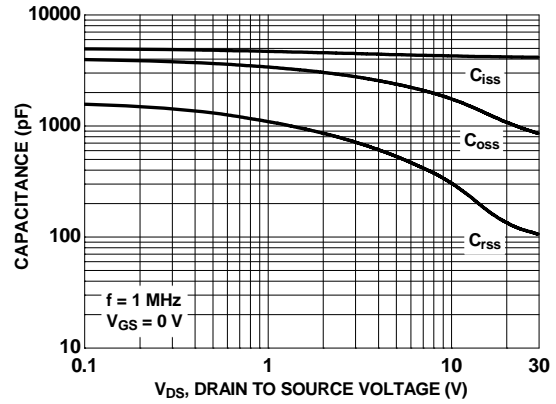

Figure 8. Capacitance vs Drain to Source Voltage

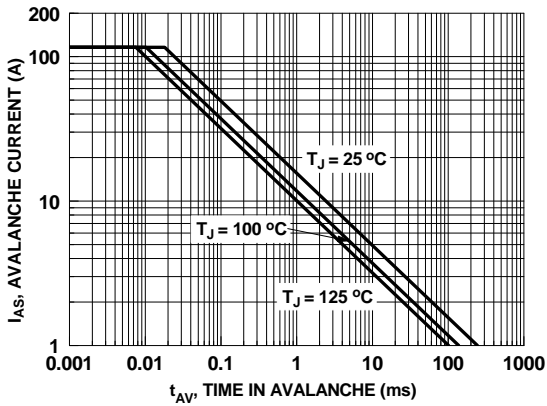

Figure 9. Unclamped Inductive Switching Capability

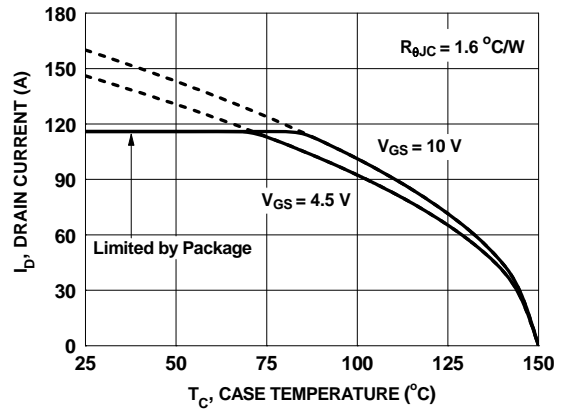

Figure 10. Maximum Continuous Drain Current vs Case Temperature

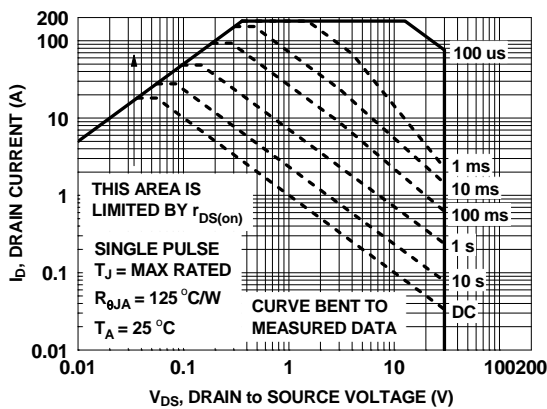

Figure 11. Forward Bias Safe Operating Area

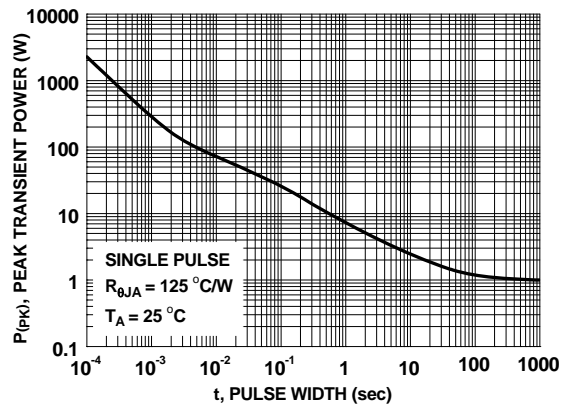

Figure 12. Single Pulse Maximum Power Dissipation

Typical Characteristics $T_J = 25\text{ }^\circ\text{C}$ unless otherwise noted

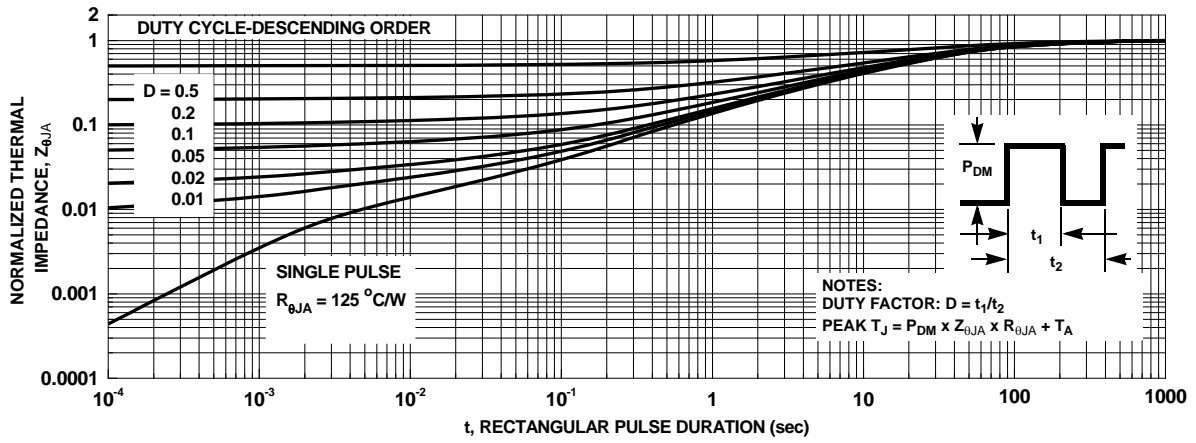
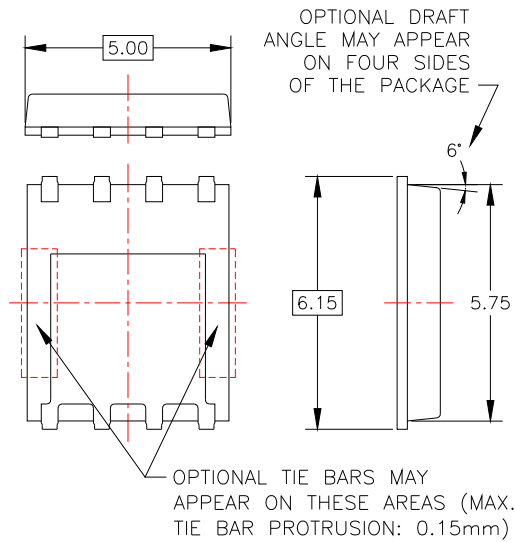
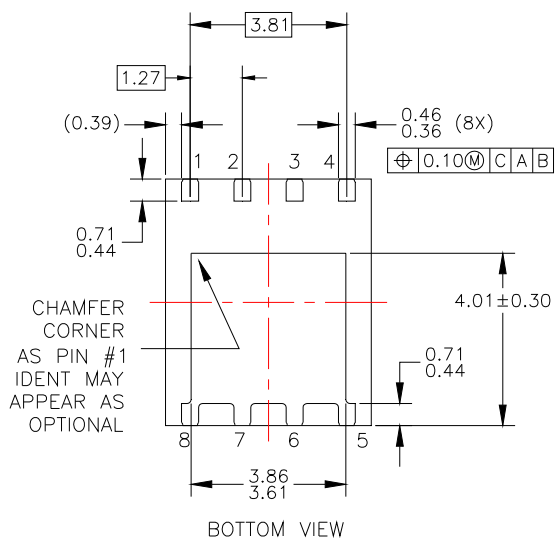
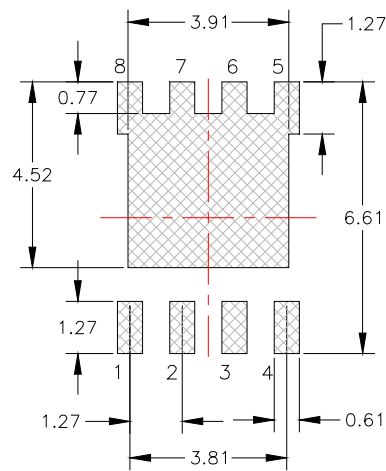
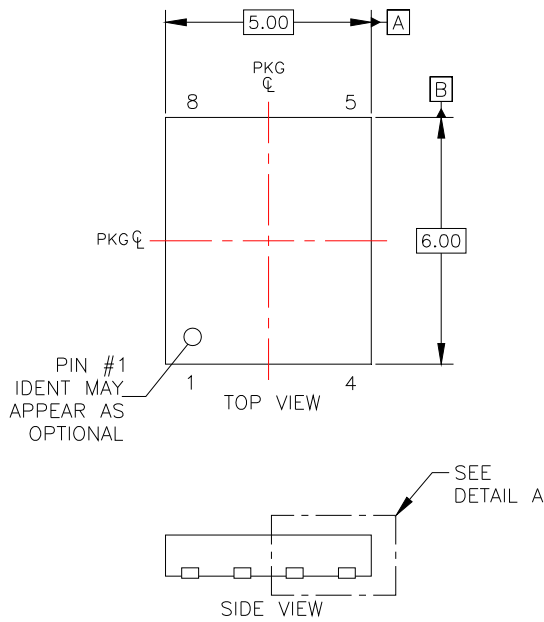

Figure 13. Junction-to-Ambient Transient Thermal Response Curve

Dimensional Outline and Pad Layout



NOTES: UNLESS OTHERWISE SPECIFIED

- A) PACKAGE STANDARD REFERENCE: JEDEC MO-240, ISSUE A, VAR. AA, DATED OCTOBER 2002.
- B) ALL DIMENSIONS ARE IN MILLIMETERS.
- C) DIMENSIONS DO NOT INCLUDE BURRS OR MOLD FLASH. MOLD FLASH OR BURRS DOES NOT EXCEED 0.10MM.
- D) DIMENSIONING AND TOLERANCING PER ASME Y14.5M-1994.
- E) DRAWING FILE NAME: PQFN08AREV4

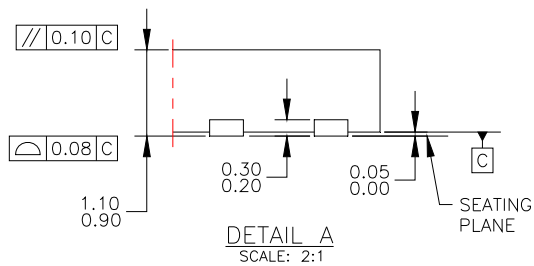



TRADEMARKS

The following includes registered and unregistered trademarks and service marks, owned by Fairchild Semiconductor and/or its global subsidiaries, and is not intended to be an exhaustive list of all such trademarks.

- | | | | |
|---|---|---|---|
| 2Cool™ | F-PFET™ | PowerTrench® | The Power Franchise® |
| AccuPower™ | FRFET® | PowerXS™ | the power® |
| AX-CAP™* | Global Power Resource™ | Programmable Active Droop™ | franchise |
| BitSiC® | Green Bridge™ | QFET® | TinyBoost™ |
| Build it Now™ | Green FPS™ | QS™ | TinyBuck™ |
| CorePLUS™ | Green FPS™ e-Series™ | Quiet Series™ | TinyCalc™ |
| CorePOWER™ | Gmax™ | RapidConfigure™ | TinyLogic® |
| CROSSVOLT™ | GTO™ | TM | TINYOPTO™ |
| CTL™ | IntelliMAX™ |  | TinyPower™ |
| Current Transfer Logic™ | ISOPLANAR™ | Saving our world, 1mW/W/kW at a time™ | TinyPWM™ |
| DEUXPEED® | Marking Small Speakers Sound Louder and Better™ | SignalWise™ | TinyWire™ |
| Dual Cool™ | MegaBuck™ | SmartMax™ | TranSiC® |
| EcoSPARK® | MICROCOUPLER™ | SMART START™ | TriFault Detect™ |
| EfficientMax™ | MicroFET™ | Solutions for Your Success™ | TRUECURRENT®* |
| ESBC™ | MicroPak™ | SPM® | µSerDes™ |
|  | MicroPak2™ | STEALTH™ |  |
| Fairchild® | MillerDrive™ | SuperFET® | UHC® |
| Fairchild Semiconductor® | MotionMax™ | SuperSOT™-3 | Ultra FRFET™ |
| FACT Quiet Series™ | Motion-SPM™ | SuperSOT™-6 | UniFET™ |
| FACT® | mWSaver™ | SuperSOT™-8 | VCX™ |
| FAST® | OptoHiT™ | SupreMOS® | VisualMax™ |
| FastvCore™ | OPTOLOGIC® | SyncFET™ | VoltagePlus™ |
| FETBench™ | OPTOPLANAR® | Sync-Lock™ | XS™ |
| FlashWriter®* |  |  | |
| FPS™ | | | |

*Trademarks of System General Corporation, used under license by Fairchild Semiconductor.

DISCLAIMER

FAIRCHILD SEMICONDUCTOR RESERVES THE RIGHT TO MAKE CHANGES WITHOUT FURTHER NOTICE TO ANY PRODUCTS HEREIN TO IMPROVE RELIABILITY, FUNCTION, OR DESIGN. FAIRCHILD DOES NOT ASSUME ANY LIABILITY ARISING OUT OF THE APPLICATION OR USE OF ANY PRODUCT OR CIRCUIT DESCRIBED HEREIN; NEITHER DOES IT CONVEY ANY LICENSE UNDER ITS PATENT RIGHTS, NOR THE RIGHTS OF OTHERS. THESE SPECIFICATIONS DO NOT EXPAND THE TERMS OF FAIRCHILD'S WORLDWIDE TERMS AND CONDITIONS, SPECIFICALLY THE WARRANTY THEREIN, WHICH COVERS THESE PRODUCTS.

LIFE SUPPORT POLICY

FAIRCHILD'S PRODUCTS ARE NOT AUTHORIZED FOR USE AS CRITICAL COMPONENTS IN LIFE SUPPORT DEVICES OR SYSTEMS WITHOUT THE EXPRESS WRITTEN APPROVAL OF FAIRCHILD SEMICONDUCTOR CORPORATION.

As used here in:

- Life support devices or systems are devices or systems which, (a) are intended for surgical implant into the body or (b) support or sustain life, and (c) whose failure to perform when properly used in accordance with instructions for use provided in the labeling, can be reasonably expected to result in a significant injury of the user.
- A critical component in any component of a life support, device, or system whose failure to perform can be reasonably expected to cause the failure of the life support device or system, or to affect its safety or effectiveness.

ANTI-COUNTERFEITING POLICY

Fairchild Semiconductor Corporation's Anti-Counterfeiting Policy. Fairchild's Anti-Counterfeiting Policy is also stated on our external website, www.Fairchildsemi.com, under Sales Support.

Counterfeiting of semiconductor parts is a growing problem in the industry. All manufactures of semiconductor products are experiencing counterfeiting of their parts. Customers who inadvertently purchase counterfeit parts experience many problems such as loss of brand reputation, substandard performance, failed application, and increased cost of production and manufacturing delays. Fairchild is taking strong measures to protect ourselves and our customers from the proliferation of counterfeit parts. Fairchild strongly encourages customers to purchase Fairchild parts either directly from Fairchild or from Authorized Fairchild Distributors who are listed by country on our web page cited above. Products customers buy either from Fairchild directly or from Authorized Fairchild Distributors are genuine parts, have full traceability, meet Fairchild's quality standards for handling and storage and provide access to Fairchild's full range of up-to-date technical and product information. Fairchild and our Authorized Distributors will stand behind all warranties and will appropriately address and warranty issues that may arise. Fairchild will not provide any warranty coverage or other assistance for parts bought from Unauthorized Sources. Fairchild is committed to combat this global problem and encourage our customers to do their part in stopping this practice by buying direct or from authorized distributors.

PRODUCT STATUS DEFINITIONS

Definition of Terms

| Datasheet Identification | Product Status | Definition |
|--------------------------|-----------------------|---|
| Advance Information | Formative / In Design | Datasheet contains the design specifications for product development. Specifications may change in any manner without notice. |
| Preliminary | First Production | Datasheet contains preliminary data; supplementary data will be published at a later date. Fairchild Semiconductor reserves the right to make changes at any time without notice to improve design. |
| No Identification Needed | Full Production | Datasheet contains final specifications. Fairchild Semiconductor reserves the right to make changes at any time without notice to improve the design. |
| Obsolete | Not In Production | Datasheet contains specifications on a product that is discontinued by Fairchild Semiconductor. The datasheet is for reference information only. |