

LOW DROPOUT POSITIVE VOLTAGE REGULATOR
DESCRIPTION

The AMS1084M series of positive adjustable and fixed regulators are designed to provide 5A with high efficiency. All internal circuitry is designed to operate down to 1.3V input to output differential. On-chip trimming adjusts the reference voltage to 1%.

APPLICATIONS

- High Efficiency Linear Regulators
- Post Regulators for Switching Supplies
- Adjustable Power Supply

FEATURES

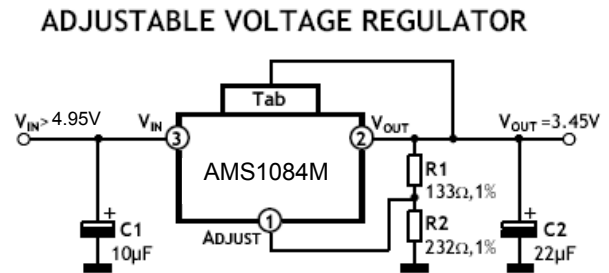
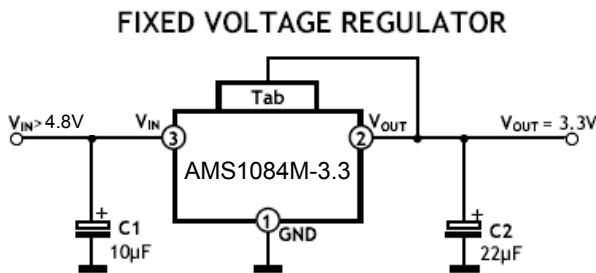

- Adjustable or Fixed Output
- Output Current of 5A
- Low Dropout, 1.5V max at 5A Output Current
- 0.04% Line Regulation
- 0.2 % Load Regulation
- 100% Thermal Limit Burn-In
- Fast Transient Response

TYPICAL APPLICATION DATA

NOTES:

- C1 needed if device is far from filter capacitors
- C2 minimum value required for stability

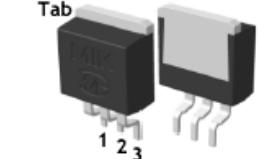
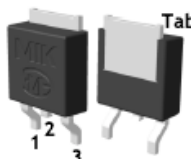
$$V_{OUT} = V_{REF} \times \left(1 + \frac{R2}{R1}\right) + I_{ADJ} \times R2$$

PIN DESCRIPTION

TO-220-3		PIN NO.	FIXED VERSION	ADJUSTABLE VERSION		TO-263-3
		1	GROUND	ADJUST		
		2	V _{OUT}	V _{OUT}		
		3	V _{IN}	V _{IN}		
TO-252-2		Tab	V _{OUT}	V _{OUT}		TO-263-2

ABSOLUTE MAXIMUM RATINGS

SYMBOL	PARAMETER	VALUE	UNIT	
V_{CC}	Power Dissipation	Internally Limited	W	
V_{IN}	Input Voltage	15	V	
T_J	Operation Junction Temperature Range		$^{\circ}\text{C}$	
		Control Section		0 to 125
		Power Transistor		0 to 150
T_{STG}	Storage Temperature Range	-65 to +150	$^{\circ}\text{C}$	
T_{LEAD}	Lead Temperature (Soldering 10 sec)	300	$^{\circ}\text{C}$	

ELECTRICAL CHARACTERISTICS
 $I_{LOAD} = 0\text{mA}$ and $T_J = +25^{\circ}\text{C}$ (unless otherwise noted)

PARAMETER	DEVICE	TEST CONDITIONS	MIN.	TYP.	MAX.	UNIT	
Reference Voltage Note 1	AMS1084M	$V_{IN} = 5\text{V}$, $I_{LOAD} = 10\text{mA}$		1.238	1.250	1.262	V
		$V_{IN} - V_{OUT} = 1.5\text{V to } 10\text{V}$, $I_{LOAD} = 10\text{mA to } 5\text{A}$	*	1.225	1.250	1.275	
Output Voltage Note 1	All fixed versions	$V_{IN} - V_{OUT} = 1.5\text{V}$, Variator from nominal V_{OUT}		-1	-	+1	%
		$V_{IN} - V_{OUT} = 1.5\text{V to } 10\text{V}$ $I_{LOAD} = 0\text{mA to } 5\text{A}$, Variator from nominal V_{OUT}	*	-2	-	+2	
Line Regulation Note 1	All	$I_{LOAD} = 10\text{mA}$, $V_{IN} - V_{OUT} = 1.5\text{V to } 10\text{V}$	*	-	0.04	0.20	%
Load Regulation Note 1	All	$V_{IN} - V_{OUT} = 1.5\text{V}$ $I_{LOAD} = 10\text{mA to } 5\text{A}$	*	-	0.2	0.40	
Minimum Load Current	AMS1084M	$V_{IN} = 5\text{V}$, $V_{ADJ} = 0\text{V}$	*	-	3	7	mA
Ground Pin Current	All fixed versions	$V_{IN} - V_{OUT} = 1.5\text{V}$ $I_{LOAD} = 10\text{mA to } 5\text{A}$	*	-	7	10	mA
Adjust Pin Current	AMS1084M	$V_{IN} - V_{OUT} = 1.5\text{V to } 10\text{V}$ $I_{LOAD} = 10\text{mA}$	*	-	40	90	μA
Current Limit	All	$V_{IN} - V_{OUT} = 1.5\text{V}$	*	5	6.5	-	A
Ripple Rejection Note 2	All	$V_{IN} - V_{OUT} = 3\text{V}$ $I_{LOAD} = 5\text{A}$	*	60	72	-	dB
Dropout Voltage Note 1,3	All	$I_{LOAD} = 5\text{A}$	*	-	1.3	1.5	V
Temperature Coefficient	All	$V_{IN} - V_{OUT} = 1.5\text{V}$, $I_{LOAD} = 10\text{mA}$	*	-	0.005	-	$\%/^{\circ}\text{C}$

The * denotes the specifications which apply over the full temperature range (see previous table, T_J)

NOTES:

- 1: Low duty pulse testing with Kelvin connections required.
- 2: 120Hz input ripple (C_{ADJ} for ADJ = $25\mu\text{F}$, $C_{OUT} = 25\mu\text{F}$)
- 3: ΔV_{OUT} , $\Delta V_{REF} = 1\%$

APPLICATION INFORMATION

The AMS1084M series of adjustable and fixed regulators are easy to use and have all the protection features expected in high performance voltage regulators: short circuit protection and thermal shut-down. Pin compatible with older three terminal adjustable regulators, these devices offer the advantage of a lower dropout voltage, more precise reference tolerance and improved reference stability with temperature.

STABILITY

The circuit design used in the AMS1084M series requires the use of an output capacitor as part of the device frequency compensation.

The addition of $150\mu\text{F}$ aluminum electrolytic or a $22\mu\text{F}$ solid tantalum on the output will ensure stability for all operating conditions.

When the adjustment terminal is bypassed with a capacitor to improve the ripple rejection, the requirement for an output capacitor increases. The value of $22\mu\text{F}$ tantalum or $150\mu\text{F}$ aluminum covers all cases of bypassing the adjustment terminal. Without bypassing the adjustment terminal smaller capacitors can be used with equally good results.

To ensure good transient response with heavy load current changes capacitor values on the order of 100 μ F are used in the output of many regulators. To further improve stability and transient response of these devices larger values of output capacitor can be used.

PROTECTION DIODES

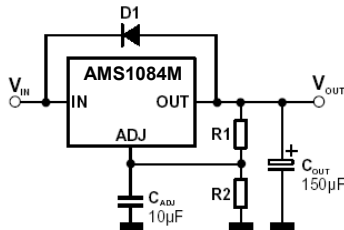

Unlike older regulators, the AMS1084M family does not need any protection diodes between the adjustment pin and the output and from the output to the input to prevent over-stressing the die.

Internal resistors are limiting the internal current paths on the AMS1084M adjustment pin, therefore even with capacitors on the adjustment pin no protection diode is needed to ensure device safety under short-circuit conditions.

Diodes between the input and output are not usually needed.

Microsecond surge currents of 50A to 100A can be handled by the internal diode between the input and output pins of the device. In normal operations it is difficult to get those values of surge currents even with the use of large output capacitances. If high value output capacitors are used, such as 1000 μ F to 5000 μ F and the input pin is instantaneously shorted to ground, damage can occur. A diode from output to input is recommended, when a crowbar circuit at the input of the AMS1084M is used. Normal power supply cycling or even plugging and unplugging in the system will not generate current large enough to do any damage.

The adjustment pin can be driven on a transient basis ± 25 V, with respect to the output without any device degradation. As with any IC regulator, none the protection circuitry will be functional and the internal transistors will break down if the maximum input to output voltage differential is exceeded.

RIPPLE REJECTION

The ripple rejection values are measured with the adjustment pin bypassed. The impedance of the adjust pin capacitor at the ripple frequency should be less than the value of R1 (normally 100 Ω to 120 Ω) for a proper bypassing and ripple rejection approaching the values shown. The size of the required adjust pin capacitor is a function of the input ripple frequency. If R1=100 Ω at 120Hz the adjust pin capacitor should be 25 μ F. At 10kHz only 0.22 μ F is needed.

The ripple rejection will be a function of output voltage, in circuits without an adjust pin bypass capacitor. The output ripple will increase directly as a ratio of the output voltage to the reference voltage (V_{OUT} / V_{REF}).

OUTPUT VOLTAGE

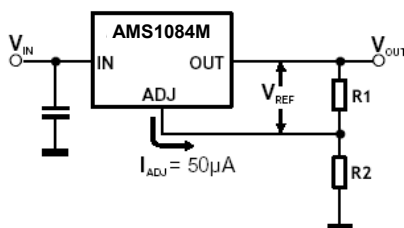

The AMS1084M series develops a 1.25V reference voltage between the output and the adjust terminal. Placing a resistor between these two terminals causes a constant current to flow through R1 and down through R2 to set the overall output voltage.

This current is normally the specified minimum load current of 10mA. Because I_{ADJ} is very small and constant it represents a small error and it can usually be ignored.

LOAD REGULATION

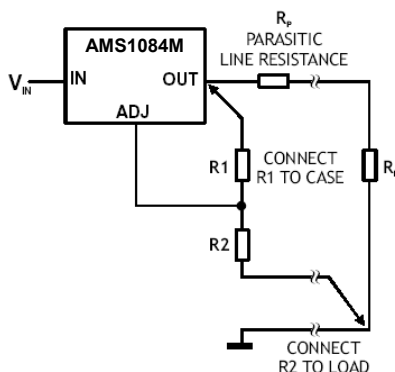

True remote load sensing it is not possible to provide, because the AMS1084M is a three terminal device. The resistance of the wire connecting the regulator to the load will limit the load regulation.

The data sheet specification for load regulation is measured at the bottom of the package. Negative side sensing is a true Kelvin connection, with the bottom of the output divider returned to the negative side of the load.

The best load regulation is obtained when the top of the resistor divider R1 is connected directly to the case not to the load. If R1 were connected to the load, the effective resistance between the regulator and the load would be:

$$\frac{R_p \times (R_2 + R_1)}{R_1}, \quad R_p = \text{Parasitic Line Resistance}$$

Connected as shown Fig.3, R_p is not multiplied by the divider ratio. Using 16-gauge wire the parasitic line resistance is about 0.004 Ω per foot, translating to 4mV/ft at 1A load current. It is important to keep the positive lead between regulator and load as short as possible and use large wire or PC board traces.