

KSA1174

KSA1174

Audio Frequency Low Noise Amplifier

- Complement to KSC2784

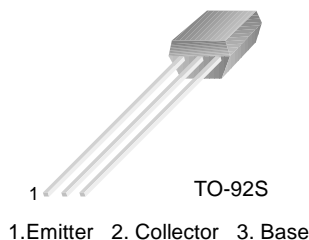

PNP Epitaxial Silicon Transistor

Absolute Maximum Ratings $T_a=25^\circ\text{C}$ unless otherwise noted

Symbol	Parameter	Ratings	Units
V_{CBO}	Collector-Base Voltage	-120	V
V_{CEO}	Collector-Emitter Voltage	-120	V
V_{EBO}	Emitter-Base Voltage	-5	V
I_C	Collector Current	-50	mA
I_B	Base Current	-10	mA
P_C	Collector Power Dissipation	300	mW
T_J	Junction Temperature	150	$^\circ\text{C}$
T_{STG}	Storage Temperature	-55 ~ 150	$^\circ\text{C}$

Electrical Characteristics $T_a=25^\circ\text{C}$ unless otherwise noted

Symbol	Parameter	Test Condition	Min.	Typ.	Max.	Units
I_{CBO}	Collector Cut-off Current	$V_{CB} = -120\text{V}, I_E = 0$			-50	nA
I_{CEO}	Collector Cut-off Current	$V_{CE} = -100\text{V}, I_B = 0$			-1	μA
I_{EBO}	Emitter Cut-off Current	$V_{EB} = -5\text{V}, I_C = 0$			-50	nA
h_{FE1} h_{FE2}	DC Current Gain	$V_{CE} = -6\text{V}, I_C = -0.1\text{mA}$ $V_{CE} = -6\text{V}, I_C = -1\text{mA}$	150 200	500 500	800	
$V_{BE}(\text{on})$	Base-Emitter On Voltage	$V_{CE} = -6\text{V}, I_C = -1\text{mA}$	-0.55	-0.61	-0.65	V
$V_{CE}(\text{sat})$	Collector-Emitter Saturation Voltage	$I_C = -10\text{mA}, I_B = -1\text{mA}$		-0.09	-0.3	V
f_T	Current Gain Bandwidth Product	$V_{CE} = -6\text{V}, I_C = -1\text{mA}$	50	100		MHz
C_{ob}	Output Capacitance	$V_{CB} = -30\text{V}, I_E = 0, f = 1\text{MHz}$		2	3	pF
NV	Noise Voltage			25	40	mV

h_{FE2} Classification

Classification	P	F	E
h_{FE2}	200 ~ 400	300 ~ 600	400 ~ 800

Typical Characteristics

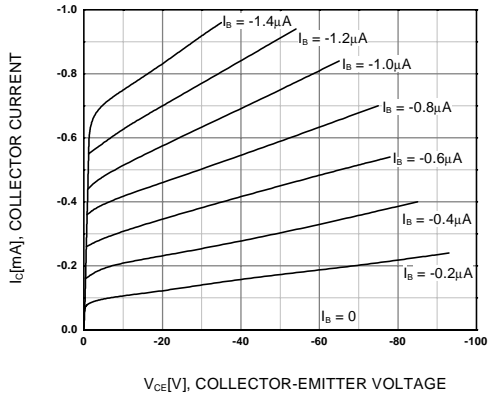

Figure 1. Static Characteristic

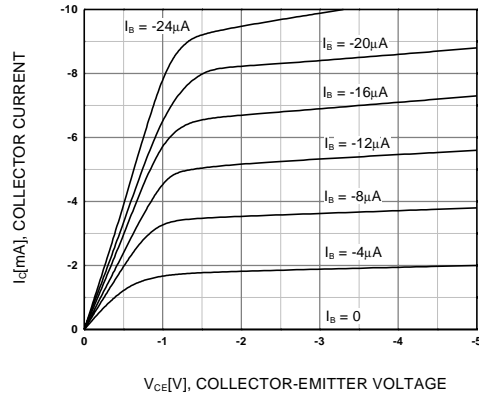

Figure 2. Static Characteristic

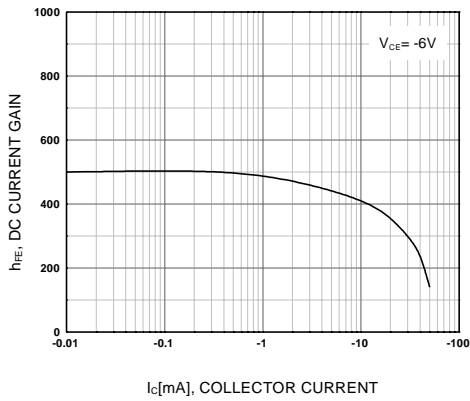

Figure 3. DC current Gain

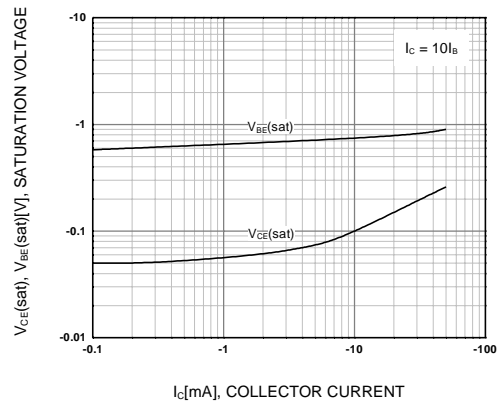

Figure 4. Base-Emitter Saturation Voltage
Collector-Emitter Saturation Voltage

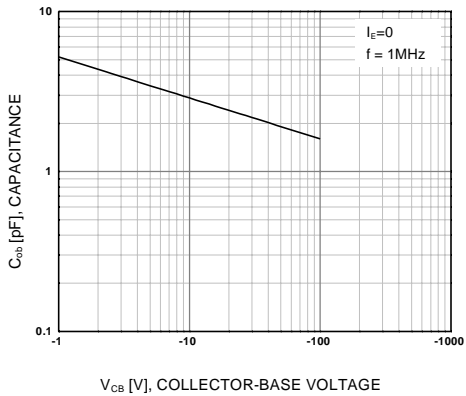

Figure 5. Collector Output Capacitance

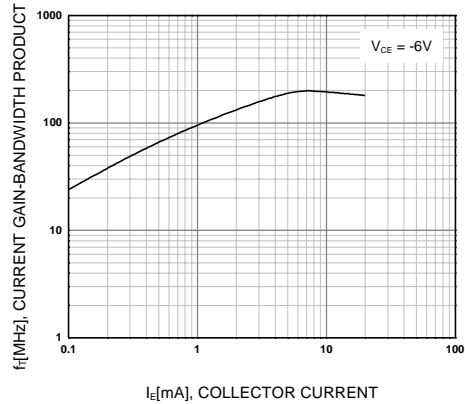

Figure 6. Current Gain Bandwidth Product

Typical Characteristics (Continued)

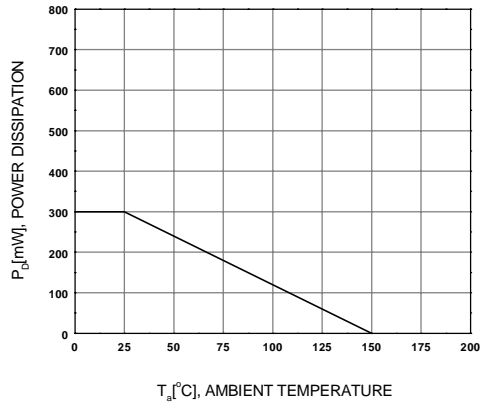
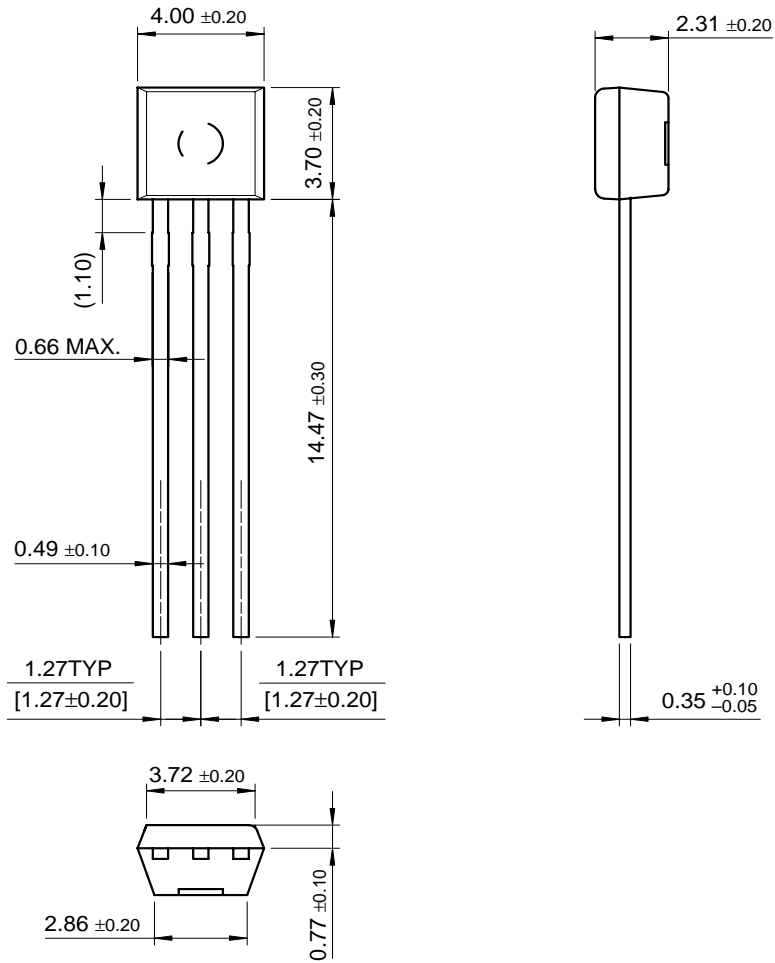

Figure 7. Power Derating

Package Dimensions

TO-92S



Dimensions in Millimeters

TRADEMARKS

The following are registered and unregistered trademarks Fairchild Semiconductor owns or is authorized to use and is not intended to be an exhaustive list of all such trademarks.

ACEx™	FAST®	OPTOPLANAR™	STAR*POWER™
Bottomless™	FASTr™	PACMAN™	Stealth™
CoolFET™	FRFET™	POP™	SuperSOT™-3
CROSSVOLT™	GlobalOptoisolator™	Power247™	SuperSOT™-6
DenseTrench™	GTO™	PowerTrench®	SuperSOT™-8
DOMET™	HiSeC™	QFET™	SyncFET™
EcoSPARK™	ISOPLANAR™	QS™	TruTranslation™
E ² CMOS™	LittleFET™	QT Optoelectronics™	TinyLogic™
EnSigna™	MicroFET™	Quiet Series™	UHC™
FACT™	MICROWIRE™	SLIENT SWITCHER®	UltraFET®
FACT Quiet Series™	OPTOLOGIC™	SMART START™	VCX™

STAR*POWER is used under license

DISCLAIMER

FAIRCHILD SEMICONDUCTOR RESERVES THE RIGHT TO MAKE CHANGES WITHOUT FURTHER NOTICE TO ANY PRODUCTS HEREIN TO IMPROVE RELIABILITY, FUNCTION OR DESIGN. FAIRCHILD DOES NOT ASSUME ANY LIABILITY ARISING OUT OF THE APPLICATION OR USE OF ANY PRODUCT OR CIRCUIT DESCRIBED HEREIN; NEITHER DOES IT CONVEY ANY LICENSE UNDER ITS PATENT RIGHTS, NOR THE RIGHTS OF OTHERS.

LIFE SUPPORT POLICY

FAIRCHILD'S PRODUCTS ARE NOT AUTHORIZED FOR USE AS CRITICAL COMPONENTS IN LIFE SUPPORT DEVICES OR SYSTEMS WITHOUT THE EXPRESS WRITTEN APPROVAL OF FAIRCHILD SEMICONDUCTOR CORPORATION.

As used herein:

1. Life support devices or systems are devices or systems which, (a) are intended for surgical implant into the body, or (b) support or sustain life, or (c) whose failure to perform when properly used in accordance with instructions for use provided in the labeling, can be reasonably expected to result in significant injury to the user.
2. A critical component is any component of a life support device or system whose failure to perform can be reasonably expected to cause the failure of the life support device or system, or to affect its safety or effectiveness.

PRODUCT STATUS DEFINITIONS

Definition of Terms

Datasheet Identification	Product Status	Definition
Advance Information	Formative or In Design	This datasheet contains the design specifications for product development. Specifications may change in any manner without notice.
Preliminary	First Production	This datasheet contains preliminary data, and supplementary data will be published at a later date. Fairchild Semiconductor reserves the right to make changes at any time without notice in order to improve design.
No Identification Needed	Full Production	This datasheet contains final specifications. Fairchild Semiconductor reserves the right to make changes at any time without notice in order to improve design.
Obsolete	Not In Production	This datasheet contains specifications on a product that has been discontinued by Fairchild semiconductor. The datasheet is printed for reference information only.

Fairchild Semiconductor

SEARCH | [Parametric](#) | [Cross Reference](#)[space](#)[Product Folders and](#)[Applies](#)[find products](#)[Home >> Find products >>](#)[Products groups](#)[Analog and Mixed](#)[Signal](#)[Discrete](#)[Interface](#)[Logic](#)[Microcontrollers](#)[Non-Volatile](#)[Memory](#)[Optoelectronics](#)[Markets and applications](#)[New products](#)[Product selection and parametric search](#)[Cross-reference search](#)

KSA1174

PNP Epitaxial Silicon Transistor

[Contents](#)[Features](#) | [Product status/pricing/packaging](#)

Features

Audio Frequency Low Noise Amplifier

- Complement to KSC2784

[back to top](#)[Product status/pricing/packaging](#)

Product	Product status	Pricing*	Package type	Leads	Packing method
KSA1174FBU	Full Production	\$0.06	TO-92S	3	BULK
KSA1174PBU	Full Production	\$0.06	TO-92S	3	BULK
KSA1174EBU	Full Production	\$0.06	TO-92S	3	BULK
KSA1174ETA	Full Production	\$0.06	TO-92S	3	TAPE REEL
KSA1174PTA	Full Production	\$0.06	TO-92S	3	TAPE REEL
KSA1174FTA	Full Production	\$0.06	TO-92S	3	TAPE REEL

* 1,000 piece Budgetary Pricing

[back to top](#)

[Home](#) | [Find products](#) | [Technical information](#) | [Buy products](#) | [Support](#) | [Company](#) | [Contact us](#) | [Site index](#) | [Privacy policy](#)

© Copyright 2002 Fairchild Semiconductor

[Related Links](#)[Request samples](#)[Dotted line](#)[How to order products](#)[Dotted line](#)[Product Change Notices](#)[\(PCNs\)](#)[Dotted line](#)[Support](#)[Dotted line](#)[Distributor and field sales representatives](#)[Dotted line](#)[Quality and reliability](#)[Dotted line](#)[Design tools](#)[Datasheet](#)[Download this datasheet](#)[PDF](#)[e-mail this datasheet](#)[\[E-\]](#)This page [Print version](#)