

FJD3305H1

NPN Silicon Transistor

Features

- High Voltage Switch Mode Application
- Fast Speed Switching
- Wide Safe Operating Area
- Suitable for Electronic Ballast Application
- Wave Soldering

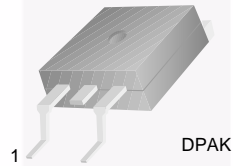

1. Base 2. Collector 3. Emitter

Absolute Maximum Ratings* $T_C = 25^\circ\text{C}$ unless otherwise noted

Symbol	Parameter	Value	Units
V_{CBO}	Collector-Base Voltage	700	V
V_{CEO}	Collector-Emitter Voltage	400	V
V_{EBO}	Emitter-Base Voltage	9	V
I_C	Collector Current (DC)	4	A
I_{CP}	Collector Current (Pulse)	8	A
I_B	Base Current	2	A
P_C	Collector Dissipation, $T_a = 25^\circ\text{C}$ $T_C = 25^\circ\text{C}$	1.1	W
		50	W
T_J	Junction Temperature	150	$^\circ\text{C}$
T_{STG}	Storage Temperature	-65 to 150	$^\circ\text{C}$

* These ratings are limiting values above which the serviceability of any semiconductor device may be impaired.

Thermal Characteristics $T_a = 25^\circ\text{C}$ unless otherwise noted

Symbol	Parameter	Value	Units
$R_{\theta JA}$	Thermal Resistance, Junction to Ambient	110	$^\circ\text{C}/\text{W}$
$R_{\theta JC}$	Thermal Resistance, Junction to Case	2.0	$^\circ\text{C}/\text{W}$

* Device mounted on minimum pad size

Ordering Information

Part Number	Marking	Package	Packing Method	Remarks
FJD3305H1TM	J3305H1	D-PAK	Tape & Reel	

Electrical Characteristics* $T_C = 25^\circ\text{C}$ unless otherwise noted

Symbol	Parameter	Conditions	Min.	Typ.	Max.	Units
BV_{CBO}	Collector-Base Breakdown Voltage	$I_C = 500\mu\text{A}, I_E = 0$	700			V
BV_{CEO}	Collector-Emitter Breakdown Voltage	$I_C = 5\text{mA}, I_B = 0$	400			V
BV_{EBO}	Emitter-Base Breakdown Voltage	$I_E = 500\mu\text{A}, I_C = 0$	9			V
I_{CBO}	Collector Cut-off Current	$V_{CB} = 700\text{V}, I_E = 0$			1	μA
I_{EBO}	Emitter Cut-off Current	$V_{EB} = 9\text{V}, I_C = 0$			1	μA
h_{FE1} h_{FE2}	DC Current Gain *	$V_{CE} = 5\text{V}, I_C = 1\text{A}$ $V_{CE} = 5\text{V}, I_C = 2\text{A}$	19 8		28 40	
$V_{CE(sat)}$	Collector-Emitter Saturation Voltage	$I_C = 1\text{A}, I_B = 0.2\text{A}$ $I_C = 2\text{A}, I_B = 0.5\text{A}$ $I_C = 4\text{A}, I_B = 1\text{A}$			0.5 0.6 1.0	V V V
$V_{BE(sat)}$	Base-Emitter Saturation Voltage	$I_C = 1\text{A}, I_B = 0.2\text{A}$ $I_C = 2\text{A}, I_B = 0.5\text{A}$			1.2 1.6	V V
f_T	Current Gain Bandwidth Product	$V_{CE} = 10\text{V}, I_C = 0.5\text{A}$	4			MHz
C_{ob}	Output Capacitance	$V_{CB} = 10\text{V}, f = 1\text{MHz}$		65		pF
t_{ON}	Turn On Time	$V_{CC} = 125\text{V}, I_C = 2\text{A}$			0.8	μs
t_{STG}	Storage Time	$I_{B1} = -I_{B2} = 0.4\text{A}$			4.0	μs
t_F	Fall Time	$R_L = 62.5\Omega$			0.9	μs

* Pulse Test: Pulse Width $\leq 300\mu\text{s}$, Duty Cycle $\leq 2\%$

Typical Performance Characteristics

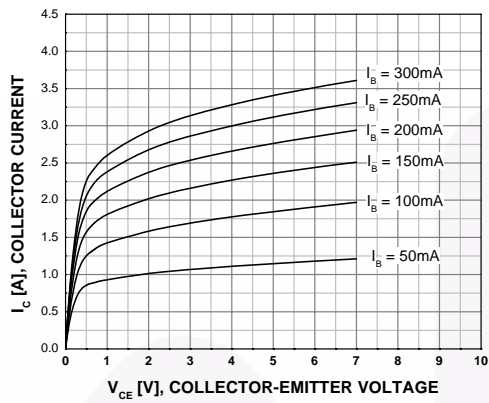

Figure 1. Static Characteristic

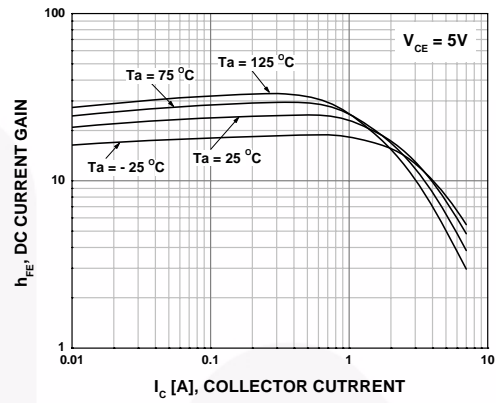

Figure 2. DC Current Gain

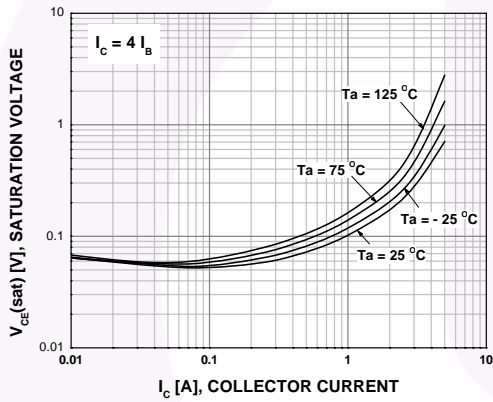

Figure 3. Collector- Emitter Saturation Voltage

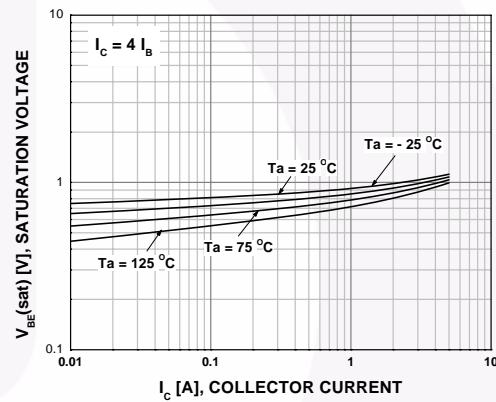

Figure 4. Base - Emitter Saturation Voltage

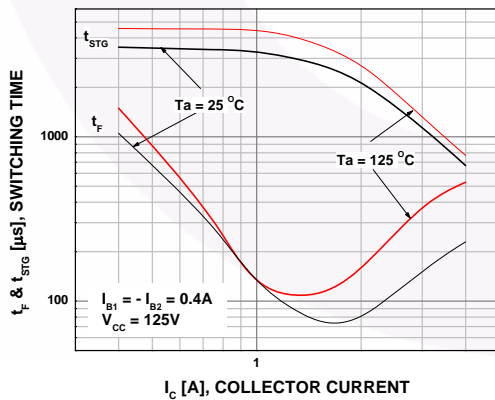

Figure 5. Switching Time

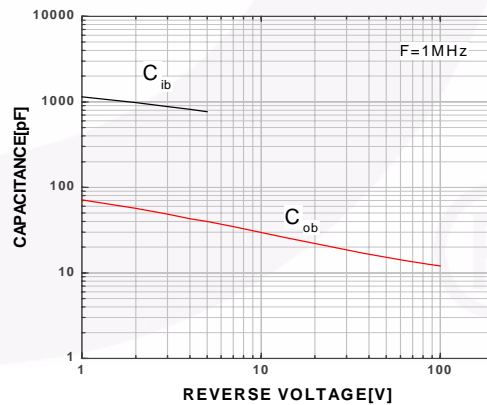

Figure 6. Capacitance

Typical Performance Characteristics (Continued)

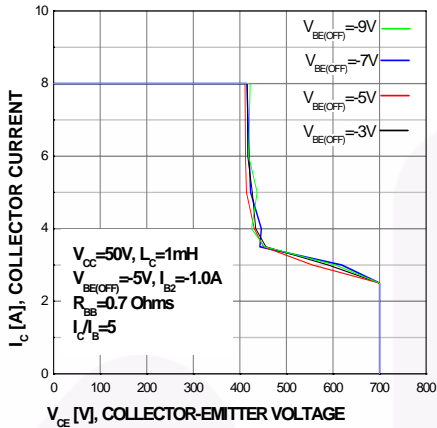

Figure 7. Reverse Biased Safe Operating Area

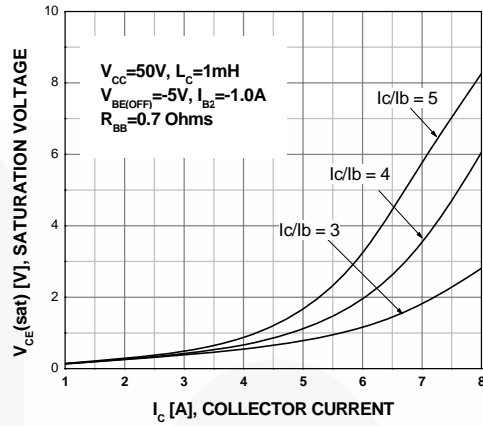

Figure 8. Collector- Emitter Saturation Voltage at RBSOA

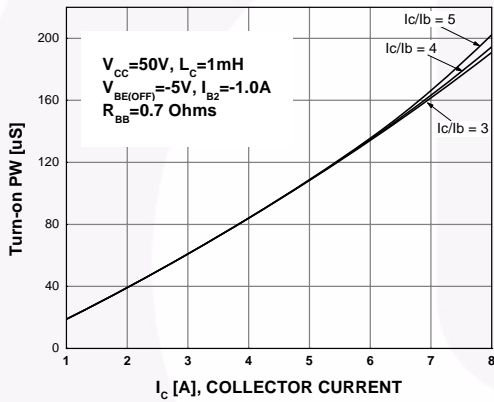

Figure 9. Input Pulse width vs Correct current at RBSOA

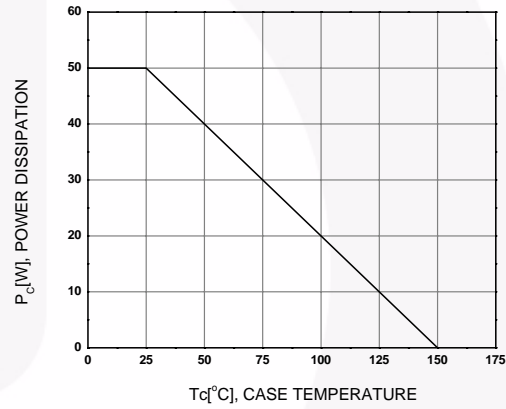

Figure 10. Power Derating

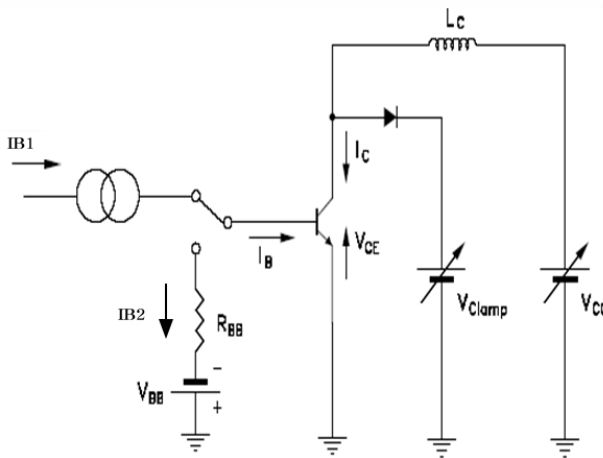
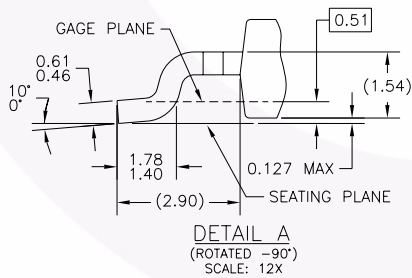
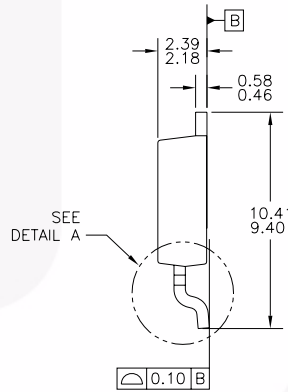
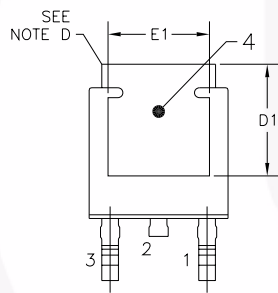
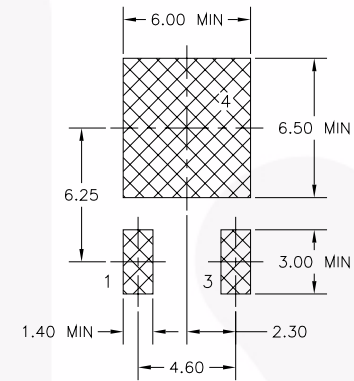
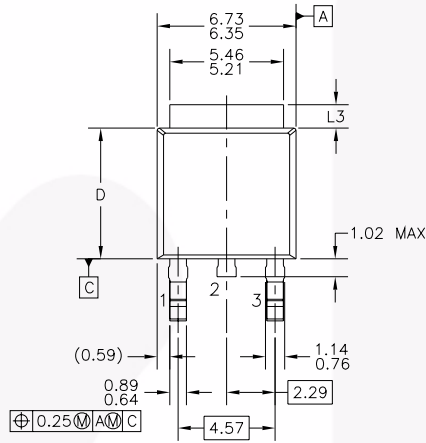

Figure 11. RBSOA Test Circuit

Physical Dimensions

D-PAK



- NOTES: UNLESS OTHERWISE SPECIFIED
- A) ALL DIMENSIONS ARE IN MILLIMETERS.
 - B) THIS PACKAGE CONFORMS TO JEDEC, TO-252, ISSUE C, VARIATION AA & AB, DATED NOV. 1999.
 - C) DIMENSIONING AND TOLERANCING PER ASME Y14.5M-1994.
 - D) HEAT SINK TOP EDGE COULD BE IN CHAMFERED CORNERS OR EDGE PROTRUSION.
 - E) DIMENSIONS L3,D,E1&D1 TABLE:
- | | OPTION AA | OPTION AB |
|----|-----------|-----------|
| L3 | 0.89-1.27 | 1.52-2.03 |
| D | 5.97-6.22 | 5.33-5.59 |
| E1 | 4.32 MIN | 3.81 MIN |
| D1 | 5.21 MIN | 4.57 MIN |
- F) PRESENCE OF TRIMMED CENTER LEAD IS OPTIONAL.

Dimensions in Millimeters



TRADEMARKS

The following includes registered and unregistered trademarks and service marks, owned by Fairchild Semiconductor and/or its global subsidiaries, and is not intended to be an exhaustive list of all such trademarks.

- | | | | |
|--|--|--|---|
| 2Cool™ | F-PFS™ | PowerTrench® | The Power Franchise® |
| AccuPower™ | FRFET® | PowerXS™ | the power franchise™ |
| AX-CAP™* | Global Power Resource SM | Programmable Active Droop™ | TinyBoost™ |
| BitSiC™ | GreenBridge™ | QFET® | TinyBuck™ |
| Build it Now™ | Green FPS™ | QS™ | TinyCalc™ |
| CorePLUS™ | Green FPS™ e-Series™ | Quiet Series™ | TinyLogic® |
| CorePOWER™ | Gmax™ | RapidConfigure™ | TINYOPTO™ |
| CROSSVOLT™ | GTO™ |  ™ | TinyPower™ |
| CTL™ | IntelliMAX™ | Saving our world, 1mW/W/kW at a time™ | TinyPwm™ |
| Current Transfer Logic™ | ISOPLANAR™ | SignalWise™ | TinyWire™ |
| DEUXPEED® | Making Small Speakers Sound Louder and Better™ | SmartMax™ | TranSiC™ |
| Dual Cool™ | MegaBuck™ | SMART START™ | TriFault Detect™ |
| EcoSPARK® | MICROCOUPLER™ | Solutions for Your Success™ | TRUECURRENT®* |
| EfficientMax™ | MicroFET™ | SPM® | µSerDes™ |
| ESBC™ | MicroPak™ | STEALTH™ |  SerDes™ |
|  Fairchild® | MicroPak2™ | SuperFET® | UHC® |
| Fairchild Semiconductor® | MillerDrive™ | SuperSOT™-3 | Ultra FRFET™ |
| FACT Quiet Series™ | MotionMax™ | SuperSOT™-6 | UniFET™ |
| FACT® | Motion-SPM™ | SuperSOT™-8 | VCX™ |
| FAST® | mWSaver™ | SupreMOS® | VisualMax™ |
| FastvCore™ | OptoHiT™ | SyncFET™ | VoltagePlus™ |
| FETBench™ | OPTOLOGIC® | Sync-Lock™ | XS™ |
| FlashWriter®* | OPTOPLANAR® |  SYSTEM GENERAL®* | |
| FPS™ | | | |

* Trademarks of System General Corporation, used under license by Fairchild Semiconductor.

DISCLAIMER

FAIRCHILD SEMICONDUCTOR RESERVES THE RIGHT TO MAKE CHANGES WITHOUT FURTHER NOTICE TO ANY PRODUCTS HEREIN TO IMPROVE RELIABILITY, FUNCTION, OR DESIGN. FAIRCHILD DOES NOT ASSUME ANY LIABILITY ARISING OUT OF THE APPLICATION OR USE OF ANY PRODUCT OR CIRCUIT DESCRIBED HEREIN; NEITHER DOES IT CONVEY ANY LICENSE UNDER ITS PATENT RIGHTS, NOR THE RIGHTS OF OTHERS. THESE SPECIFICATIONS DO NOT EXPAND THE TERMS OF FAIRCHILD'S WORLDWIDE TERMS AND CONDITIONS, SPECIFICALLY THE WARRANTY THEREIN, WHICH COVERS THESE PRODUCTS.

LIFE SUPPORT POLICY

FAIRCHILD'S PRODUCTS ARE NOT AUTHORIZED FOR USE AS CRITICAL COMPONENTS IN LIFE SUPPORT DEVICES OR SYSTEMS WITHOUT THE EXPRESS WRITTEN APPROVAL OF FAIRCHILD SEMICONDUCTOR CORPORATION.

As used herein:

- Life support devices or systems are devices or systems which, (a) are intended for surgical implant into the body or (b) support or sustain life, and (c) whose failure to perform when properly used in accordance with instructions for use provided in the labeling, can be reasonably expected to result in a significant injury of the user.
- A critical component in any component of a life support, device, or system whose failure to perform can be reasonably expected to cause the failure of the life support device or system, or to affect its safety or effectiveness.

ANTI-COUNTERFEITING POLICY

Fairchild Semiconductor Corporation's Anti-Counterfeiting Policy. Fairchild's Anti-Counterfeiting Policy is also stated on our external website, www.fairchildsemi.com, under Sales Support.

Counterfeiting of semiconductor parts is a growing problem in the industry. All manufacturers of semiconductor products are experiencing counterfeiting of their parts. Customers who inadvertently purchase counterfeit parts experience many problems such as loss of brand reputation, substandard performance, failed applications, and increased cost of production and manufacturing delays. Fairchild is taking strong measures to protect ourselves and our customers from the proliferation of counterfeit parts. Fairchild strongly encourages customers to purchase Fairchild parts either directly from Fairchild or from Authorized Fairchild Distributors who are listed by country on our web page cited above. Products customers buy either from Fairchild directly or from Authorized Fairchild Distributors are genuine parts, have full traceability, meet Fairchild's quality standards for handling and storage and provide access to Fairchild's full range of up-to-date technical and product information. Fairchild and our Authorized Distributors will stand behind all warranties and will appropriately address any warranty issues that may arise. Fairchild will not provide any warranty coverage or other assistance for parts bought from Unauthorized Sources. Fairchild is committed to combat this global problem and encourage our customers to do their part in stopping this practice by buying direct or from authorized distributors.

PRODUCT STATUS DEFINITIONS

Definition of Terms

Datasheet Identification	Product Status	Definition
Advance Information	Formative / In Design	Datasheet contains the design specifications for product development. Specifications may change in any manner without notice.
Preliminary	First Production	Datasheet contains preliminary data; supplementary data will be published at a later date. Fairchild Semiconductor reserves the right to make changes at any time without notice to improve design.
No Identification Needed	Full Production	Datasheet contains final specifications. Fairchild Semiconductor reserves the right to make changes at any time without notice to improve the design.
Obsolete	Not In Production	Datasheet contains specifications on a product that is discontinued by Fairchild Semiconductor. The datasheet is for reference information only.