

# REAL TIME CLOCK MODULE WITH 32.768kHz TCXO

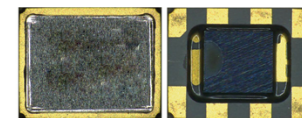

3.2 x 2.5 x 1.0 mm

**AB-RTCMK-32.768kHz**

Moisture Sensitivity Level: MSL=1



**RoHS**  
Compliant

## FEATURES:

- Ultra low profile, 3.2 x 2.5 x 1.0 mm, Seam sealed SMT package
- Exceptional Frequency Stability over temperature;  $\pm 5.0$  ppm max. over  $-40^{\circ}\text{C}$  to  $+85^{\circ}\text{C}$
- Operating Voltage;  $+1.30\text{V}$  to  $+5.50\text{V}$
- $4.0\mu\text{A}$  max. current at no load
- I2C Communication
- Clock function : Hour/ Min / Sec
- Leap year automatic distinction calendar function till 2099
- Alarm interruption function for day, date, hour and minute settings
- A constant cycle timer interruption function : 244.14us to 255 min
- Time update interruption function : Min / Sec
- Clock output function : 32.768kHz / 1024Hz / 32Hz / 1Hz

## APPLICATIONS:

- Smart cards
- Wireless sensors and tags
- Medical electronics
- Utility meters
- Data loggers
- Appliances
- Handsets
- Consumer electronics

## STANDARD SPECIFICATIONS:

| Parameters  | Minimum               | Typical | Maximum               | Units | Notes   |
|---|-----------------------|---------|-----------------------|-------|---|
| Nominal Frequency (f0)                            |                       | 32.768  |                       | kHz   |   |
| Frequency Tolerance (df/f0)                       | -3.0                  |         | +3.0                  | ppm   | Initial + 2 times reflow<br>Ta= $\pm 25 \pm 2^{\circ}\text{C}$  |
| Frequency Stability vs Temp. (df/f0)              | -5.0                  |         | +5.0                  | ppm   | Ta= $-40$ to $+85^{\circ}\text{C}$  |
| Frequency Stability vs Voltage (df/dV)            | -1.0                  |         | +1.0                  | ppm/V | Ta= $\pm 25^{\circ}\text{C}$<br>V <sub>DD</sub> =2.0 to 5.5V  |
| Frequency Aging Rate (dfag)                       | -3.0                  |         | +3.0                  | ppm   | Ta= $\pm 25^{\circ}\text{C}$ , first year   |
| Start Up Time (Tst)                               |                       |         | 1.0                   | sec   | Ta= $\pm 25^{\circ}\text{C}$<br>V <sub>DD</sub> =1.3V   |
|   |                       |         | 3.0                   | sec   | Ta= $-40$ to $+85^{\circ}\text{C}$<br>V <sub>DD</sub> =1.3 to 5.5V                                      |
| Power Supply Current 1 (I <sub>DD1</sub> )        |                       | 0.6     | 2.0                   | uA    | SCL=SDA=/INT=V <sub>DD</sub><br>CLKOUT=V <sub>SS</sub> ,<br>V <sub>DD</sub> =3V                         |
| Power Supply Current 2 (I <sub>DD2</sub> )        |                       | 1.5     | 4.0                   | uA    | SCL=SDA=/INT=V <sub>DD</sub><br>CLKOUT=V <sub>DD</sub> ,<br>V <sub>DD</sub> =3V, CL <sub>OUT</sub> =0pF |
| Input Leak Current (I <sub>LK</sub> )             | -0.5                  |         | +0.5                  | uA    | CLKOE,SCL,SDA<br>V <sub>IN</sub> =V <sub>DD</sub> or V <sub>SS</sub>                                    |
| Output Leak Current (I <sub>OZ</sub> )            | -0.5                  |         | +0.5                  | uA    | CLKOUT,/INT,SDA<br>V <sub>OUT</sub> =V <sub>DD</sub> or V <sub>SS</sub>                                 |
| “H” Input Voltage (V <sub>IH</sub> )              | 0.8 x V <sub>DD</sub> |         | 5.5                   | V     | CLKOE,SCL,SDA   |
| “L” Input Voltage (V <sub>IL</sub> )              | 0.0                   |         | 0.2 x V <sub>DD</sub> | V     | CLKOE,SCL,SDA   |
| “H” Output Voltage (V <sub>OH</sub> )             | 2.2                   |         | 3.0                   | V     | CLKOUT, V <sub>DD</sub> =3.0V,<br>I <sub>OH</sub> =-1mA   |
| “L” Output Voltage                                | V <sub>OL1</sub>      | 0.0     | 0.8                   | V     | CLKOUT, V <sub>DD</sub> =3.0V,<br>I <sub>OL</sub> =1mA  |
|   | V <sub>OL2</sub>      | 0.0     | 0.4                   | V     | /INT, V <sub>DD</sub> =3.0V,<br>I <sub>OL</sub> =1mA  |
|   | V <sub>OL3</sub>      | 0.0     | 0.4                   | V     | SDA, V <sub>DD</sub> $\geq$ 2.0V,<br>I <sub>OL</sub> =3mA   |
| Low Voltage Detection Voltage (V <sub>DET</sub> ) | 1.3                   | 1.4     | 1.5                   | V     |   |

For detail data sheet, please contact [tech-support@abracon.com](mailto:tech-support@abracon.com)

ABRACON IS  
ISO 9001 : 2008  
CERTIFIED



**ABRACON**  
CORPORATION

Visit [www.abracon.com](http://www.abracon.com) for Terms & Conditions of Sale

Revised: 09.30.12

30332 Esperanza, Rancho Santa Margarita, California 92688

tel 949-546-8000 | fax 949-546-8001 | [www.abracon.com](http://www.abracon.com)

# REAL TIME CLOCK MODULE WITH 32.768kHz TCXO

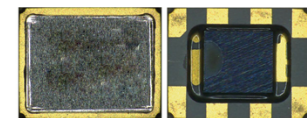

3.2 x 2.5 x 1.0 mm

AB-RTCMK-32.768kHz



**RoHS**  
Compliant

## AC ELECTRICAL CHARACTERISTICS

| Parameters   | Minimum | Typical | Maximum | Units | Notes      |
|--|---------|---------|---------|-------|------------|
| SCL Clock Frequency ( $f_{SCL}$ )                            |         |         | 400     | kHz   |            |
| START Condition Setup Time ( $t_{SU,STA}$ )                  | 0.6     |         |         | sec   |            |
| START Condition Hold Time ( $t_{HD,STA}$ )                   | 0.6     |         |         | sec   |            |
| Data Input Setup Time ( $t_{SU,DAT}$ )                       | 100     |         |         | nsec  |            |
| Data Input Hold Time ( $t_{HD,DAT}$ )                        | 0       |         | 900     | nsec  |            |
| STOP Condition Setup Time ( $t_{SU,STO}$ )                   | 0.6     |         |         | sec   |            |
| Bus Idle Time Between START and STOP Condition ( $t_{BUF}$ ) | 1.3     |         |         | sec   |            |
| SCL Low Time ( $t_{LOW}$ )                                   | 1.3     |         |         | sec   |            |
| SCL High Time ( $t_{HIGH}$ )                                 | 0.6     |         |         | sec   |            |
| SCL, SDA Rise Time ( $t_r$ )                                 |         |         | 0.3     | sec   | 20% to 80% |
| SCL, SDA Fall Time ( $t_f$ )                                 |         |         | 0.3     | sec   | 80% to 20% |
| Allowable Spike Time on Bus ( $t_{SP}$ )                     |         |         | 50      | nsec  |            |

## TIMING CHART

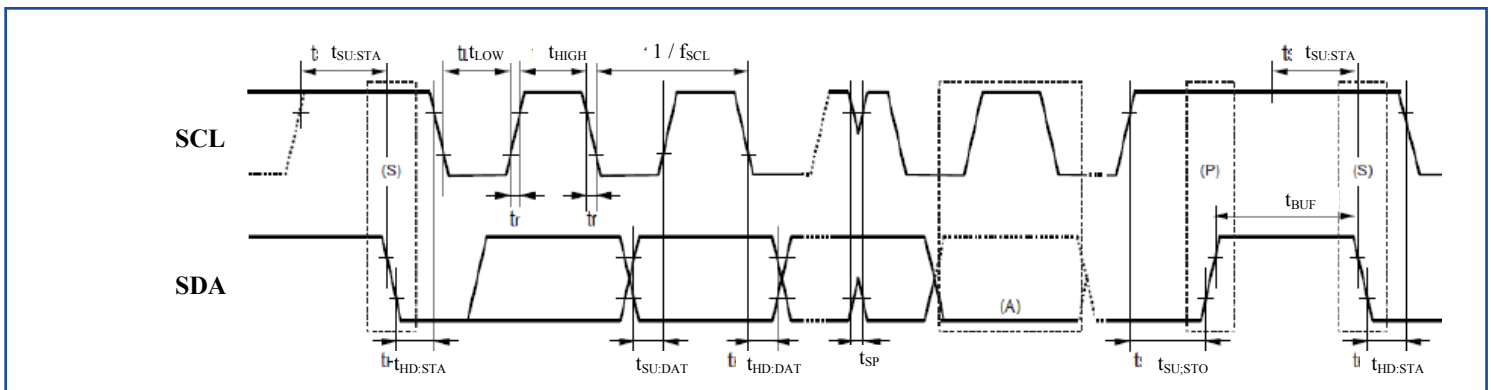

## PART IDENTIFICATION:

AB - RTCMK - 32.768 kHz -

| Packaging         |
|-------------------|
| Blank: Bulk       |
| T: 1000pcs/reel   |
| T3*: 3000pcs/reel |

\*3000pcs/reel: standard reel quantity

ABRACON IS  
ISO 9001 : 2008  
CERTIFIED



**ABRACON**  
CORPORATION

Visit [www.abracon.com](http://www.abracon.com) for Terms & Conditions of Sale **Revised: 09.30.12**  
30332 Esperanza, Rancho Santa Margarita, California 92688  
tel 949-546-8000 | fax 949-546-8001 | [www.abracon.com](http://www.abracon.com)

# REAL TIME CLOCK MODULE WITH 32.768kHz TCXO

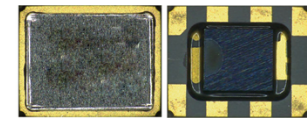

3.2 x 2.5 x 1.0 mm

AB-RTCMK-32.768kHz



RoHS  
Compliant

## FUNCTION:

| Pin No. | Pin Name | I/O    | Function   |
|---------|----------|--------|--|
| 1       | CLKOE    | Input  | This is an input pin used to control the output mode of the CLKOUT pin. When this pin's level is high, the CLKOUT pin is in output mode. When it is low, the CLKOUT pin is "Hi-Z" (High Impedance).  |
| 2       | /INT     | Output | This pin is used to output alarm signals, timer signals, timer update signals, and other signals. This pin is an open drain pin.   |
| 3       | N.C.     |        | This pin is open.  |
| 4       | VSS      |        | This pin is connected to ground.   |
| 5       | CLKOUT   | Output | This pin outputs a 32.768kHz signal. This is the C-MOS output pin with output control provided via the CLKOE pin.  |
| 6       | SCL      | Input  | This is the serial clock input for I <sup>2</sup> C BUS communications.  |
| 7       | SDA      | I/O    | This is the serial data input/output for I <sup>2</sup> C BUS communications. This pin's signal is used for input and output of address, data, and ACK bits, synchronized with the serial clock used for I <sup>2</sup> C communication. This pin is an N-ch open drain pin during output. |
| 8       | VDD      |        | This pin is connected to a positive power supply.  |

## BLOCK DIAGRAM:

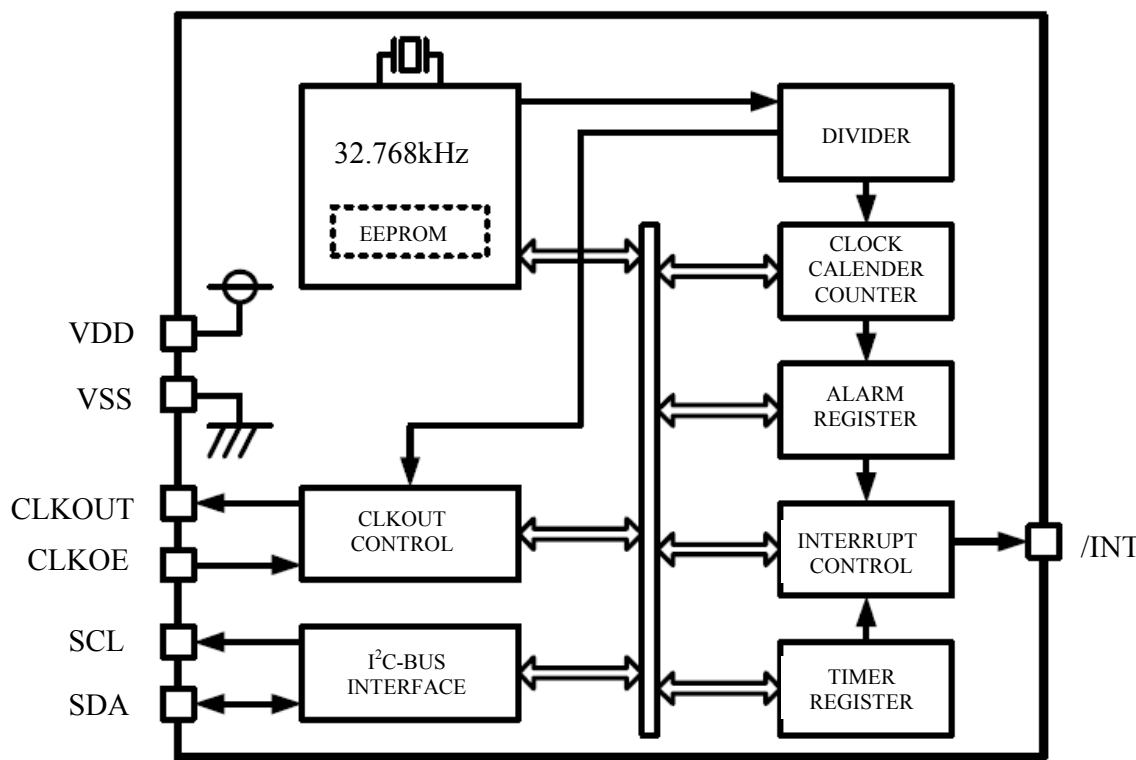

# REAL TIME CLOCK MODULE WITH 32.768kHz TCXO

AB-RTCMK-32.768kHz



RoHS  
Compliant

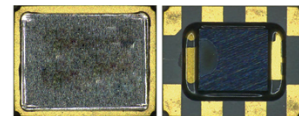

3.2 x 2.5 x 1.0 mm

## MARKING:

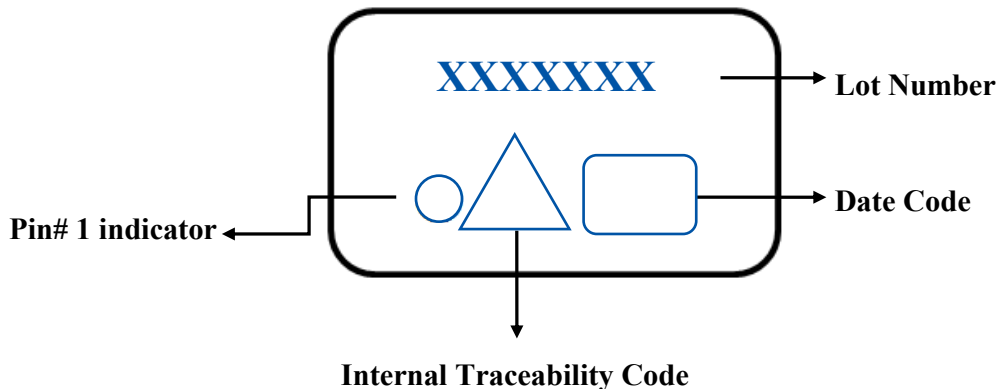

## OUTLINE DRAWING:

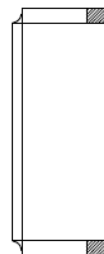
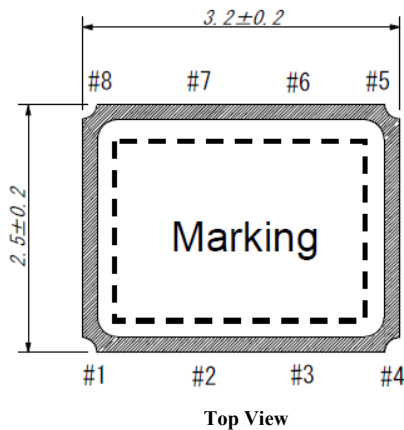

### PIN / Function

|            |             |
|------------|-------------|
| #1 : CLKOE | #5 : CLKOUT |
| #2 : /INT  | #6 : SCL    |
| #3 : N.C.  | #7 : SDA    |
| #4 : VSS   | #8 : VDD    |

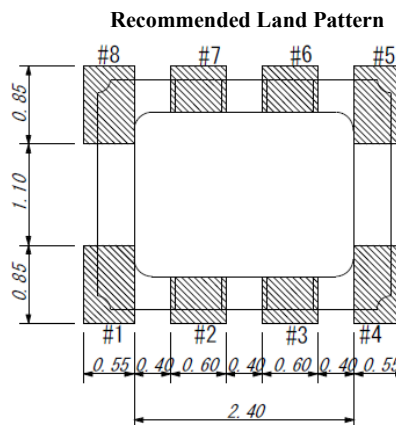
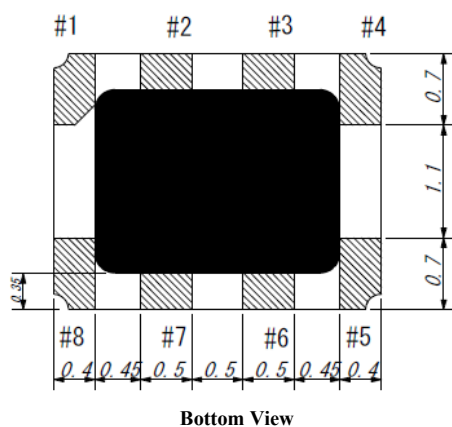

Dimension : mm

ABRACON IS  
ISO 9001 : 2008  
CERTIFIED



ABRACON  
CORPORATION

Visit [www.abracon.com](http://www.abracon.com) for Terms & Conditions of Sale

Revised: 09.30.12

30332 Esperanza, Rancho Santa Margarita, California 92688

tel 949-546-8000 | fax 949-546-8001 | [www.abracon.com](http://www.abracon.com)

# REAL TIME CLOCK MODULE WITH 32.768kHz TCXO

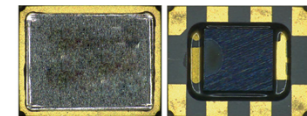

3.2 x 2.5 x 1.0 mm

AB-RTCMK-32.768kHz



RoHS  
Compliant

## TAPE & REEL:

T: 1000pcs/reel

T3: 3000pcs/reel (standard reel quantity)

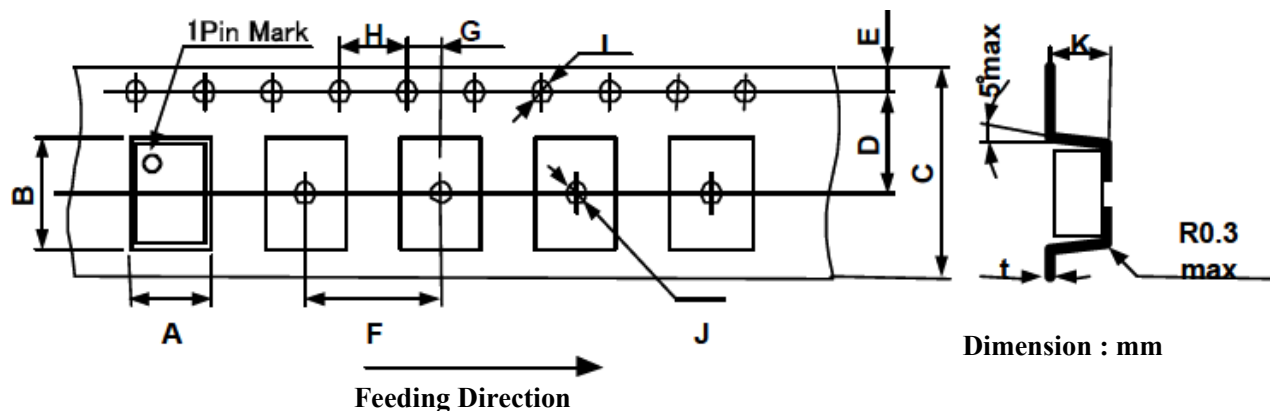

| A           | B          | C            | D             | E          | F           |
|-------------|------------|--------------|---------------|------------|-------------|
| 2.80 ± 0.1  | 3.50 ± 0.1 | 8.00 ± 0.3   | 3.50 ± 0.05   | 1.75 ± 0.1 | 4.00 ± 0.1  |
| G           | H          | I            | J             | K          | T           |
| 2.00 ± 0.05 | 4.00 ± 0.1 | ø1.5 +1.0/-0 | ø 1.5 +1.0/-0 | 1.10 ± 0.1 | 0.25 ± 0.05 |

### Reel Dimensions

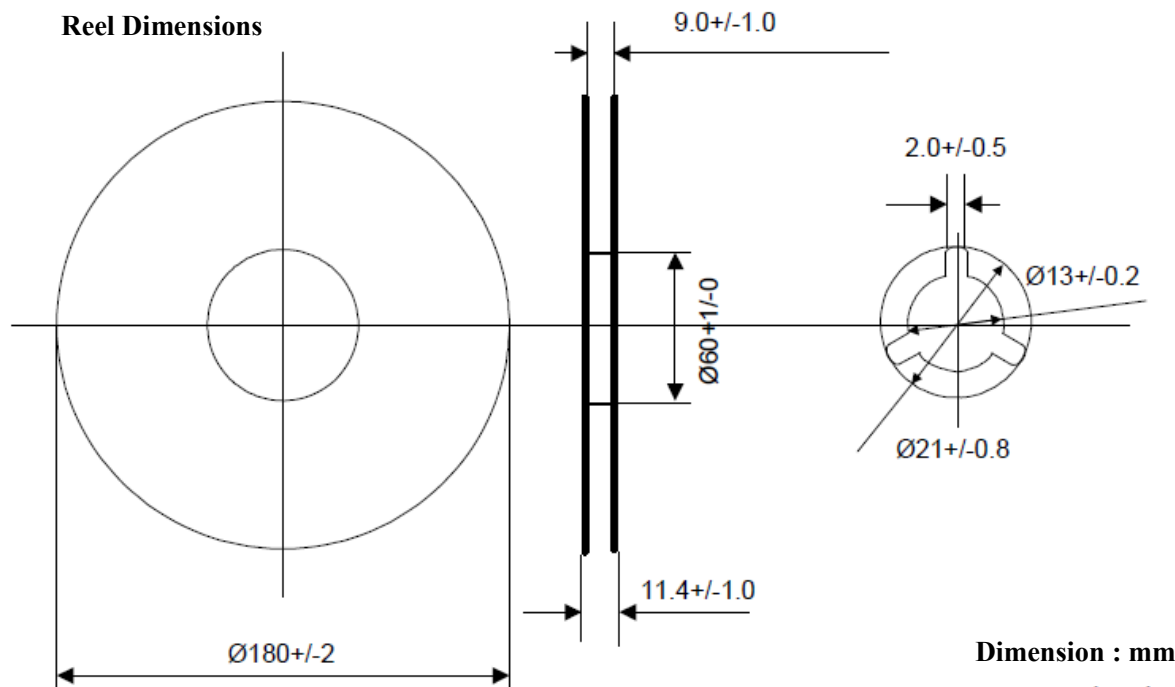

For detail data sheet, please contact [tech-support@abracon.com](mailto:tech-support@abracon.com)

**ATTENTION:** Abracon Corporation's products are COTS – Commercial-Off-The-Shelf products; suitable for Commercial, Industrial and, where designated, Automotive Applications. Abracon's products are not specifically designed for Military, Aviation, Aerospace, Life-dependant Medical applications or any application requiring high reliability where component failure could result in loss of life and/or property. For applications requiring high reliability and/or presenting an extreme operating environment, written consent and authorization from Abracon Corporation is required. Please contact Abracon Corporation for more information.

ABRACON IS  
ISO 9001 : 2008  
CERTIFIED



Visit [www.abracon.com](http://www.abracon.com) for Terms & Conditions of Sale **Revised: 09.30.12**  
30332 Esperanza, Rancho Santa Margarita, California 92688  
tel 949-546-8000 | fax 949-546-8001 | [www.abracon.com](http://www.abracon.com)