

# RMPA2455

## 2.4–2.5 GHz 1 Watt InGaP HBT Linear Power Amplifier

### Features

- 30 dB small signal gain
- 30 dBm output power @ 1 dB compression
- 3% EVM at 22 dBm modulated power out
- 5.0 V positive collector supply operation
- Two power saving shutdown options (bias and logic control)
- Integrated power detector with 20 dB dynamic range
- Low profile 16 pin 3 x 3 x 0.9 mm leadless package
- Internally matched to 50Ω and DC blocked RF input/output
- Optimized for use in 802.11b/g Access Point applications

### General Description

The RMPA2455 power amplifier is designed for high performance WLAN access point applications in the 2.4–2.5 GHz frequency band. The low profile 16 pin 3 x 3 x 0.9 mm package with internal matching on both input and output to 50Ω minimizes next level PCB space and allows for simplified integration. The on-chip detector provides power sensing capability while the logic control provides power saving shutdown options. The PA's low power consumption and excellent linearity are achieved using our InGaP Heterojunction Bipolar Transistor (HBT) technology.

### Device



### Electrical Characteristics<sup>1</sup> 802.11g OFDM Modulation

(with 176 ms burst time, 100 ms idle time) 54 Mbps Data Rate, 16.7 MHz Bandwidth

Parameter	Min	Typ	Max	Units
Frequency	2.4		2.5	GHz
Collector Supply Voltage	4.5	5.0	5.5	V
Mirror Supply Voltage	2.8	3.3	3.6	V
Gain		30		dB
Total Current @ 22dBm P <sub>OUT</sub>		195		mA
EVM @ 22dBm P <sub>OUT</sub> <sup>2</sup>		3.0		%
Detector Output @ 22dBm P <sub>OUT</sub>		960		mV
Detector Threshold <sup>3</sup>		4		dBm

**Notes:**

1. VC1, VC2 = 5.0 Volts, VM12 = 3.3V, T<sub>A</sub> = 25°C, PA is constantly biased, 50Ω system.
2. Percentage includes system noise floor of EVM = 0.8%.
3. P<sub>OUT</sub> measured at P<sub>IN</sub> corresponding to power detection threshold.

## Electrical Characteristics<sup>1</sup> Single Tone

Parameter	Min	Typ	Max	Units
Frequency	2.4		2.5	GHz
Collector Supply Voltage	4.5	5.0	5.5	V
Mirror Supply Voltage	2.8	3.3	3.6	V
Gain		30		dB
Total Quiescent Current		140		mA
Bias Current at pin VM12 <sup>2</sup>		17		mA
P1dB Compression		30		dBm
Standby Current <sup>3</sup>		0.7		mA
Shutdown Current (VM12 = 0V)		<1.0		μA
Input Return Loss		12		dB
Output Return Loss		10		dB
Detector Output at P1dB Comp		4		V
Detector P <sub>OUT</sub> Threshold <sup>7</sup>		6		dBm
2nd Harmonic Output at P1dB		-40		dBc
3rd Harmonic Output at P1dB		-40		dBc
Logic				
Shutdown Control (V <sub>L</sub> ):				
Device Off, Logic High Input	2.0	2.4		V
Device On, Logic Low Input		0.0	0.8	V
Logic Current		150		μA
Turn-on Time <sup>4</sup>		<1		μS
Turn-off Time		<1		μS
Spurious (Stability) <sup>5</sup>		-65		dBc

## Absolute Ratings<sup>6</sup>

Symbol	Parameter	Ratings	Units
VC1, VC2	Positive Supply Voltage	6	V
IC1, IC2	Supply Current		
	IC1	120	mA
	IC2	700	mA
VM12	Positive Bias Voltage	4.0	V
V <sub>L</sub>	Logic Voltage	5	V
P <sub>IN</sub>	RF Input Power	10	dBm
T <sub>CASE</sub>	Case Operating Temperature	-40 to +85	°C
T <sub>STG</sub>	Storage Temperature	-55 to +150	°C

### Notes:

- VC1, VC2 = 5.0V, VM12 = 3.3V, T<sub>C</sub> = 25°C, 50Ω system.
- Mirror bias current is included in the total quiescent current.
- V<sub>L</sub> is set to Input Logic Level High for PA Off operation.
- Measured from Device On signal turn on (Logic Low) to the point where RF P<sub>OUT</sub> stabilizes to 0.5dB.
- Load VSWR is set to 8:1 and the angle is varied 360 degrees. P<sub>OUT</sub> = -30dBm to P1dB.
- No permanent damage with only one parameter set at extreme limit. Other parameters set to typical values
- P<sub>OUT</sub> measured at P<sub>IN</sub> corresponding to power detection threshold.

### Functional Block Diagram

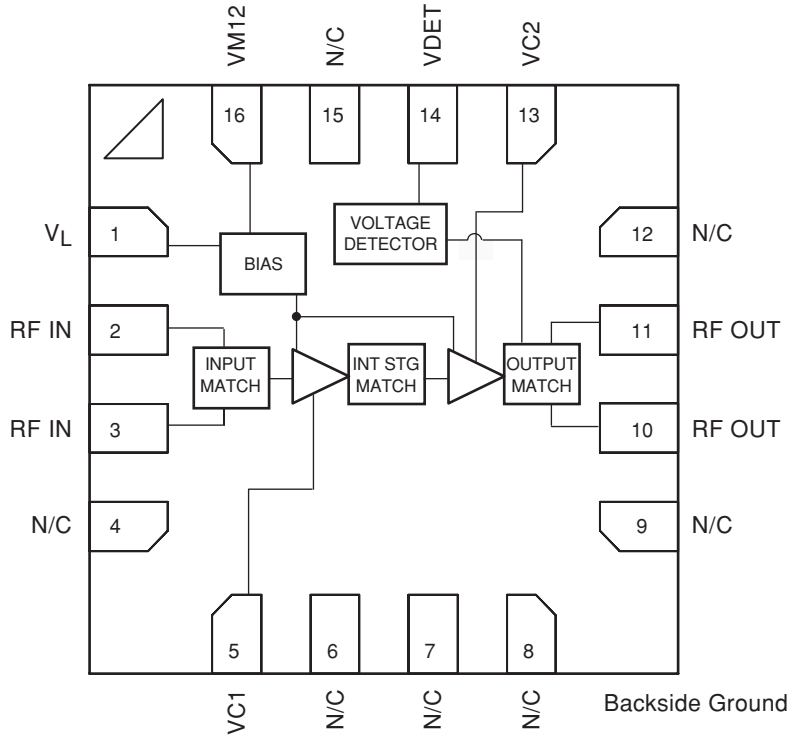

Pin	Description
1	V <sub>L</sub> (logic)
2	RF IN
3	RF IN
4	N/C
5	VC1
6	N/C
7	N/C
8	N/C
9	N/C
10	RF OUT
11	RF OUT
12	N/C
13	VC2
14	VDET
15	N/C
16	VM12

## Performance Data 802.11g OFDM

Modulation (with 176 ms burst time, 100 ms idle time) 54 Mbps Data Rate, 16.7 MHz Bandwidth

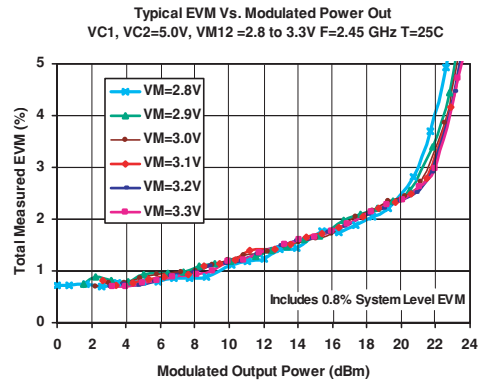
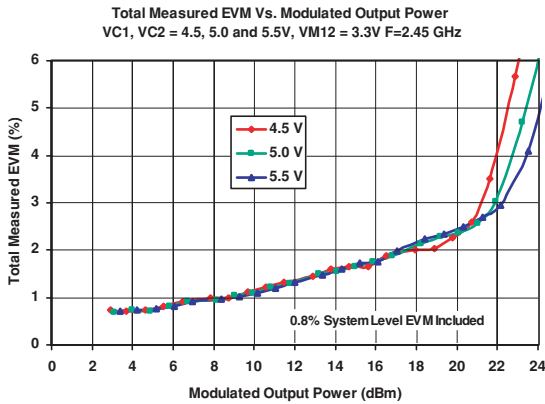
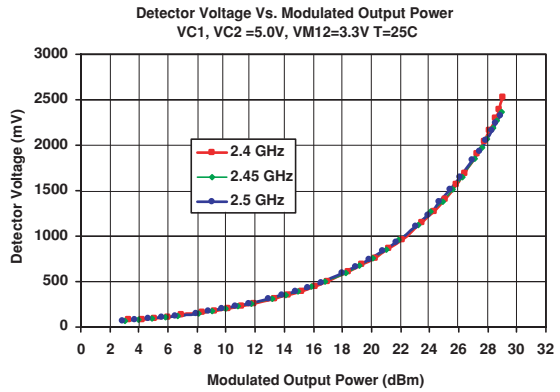
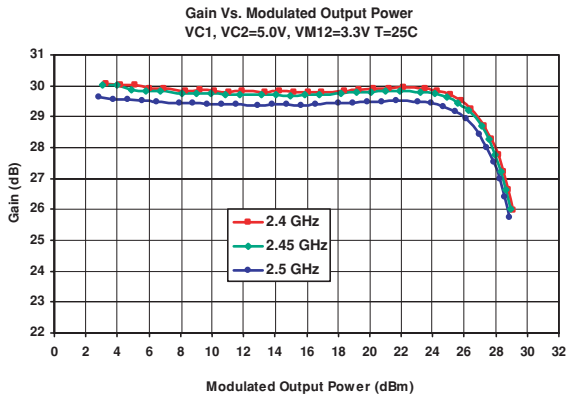
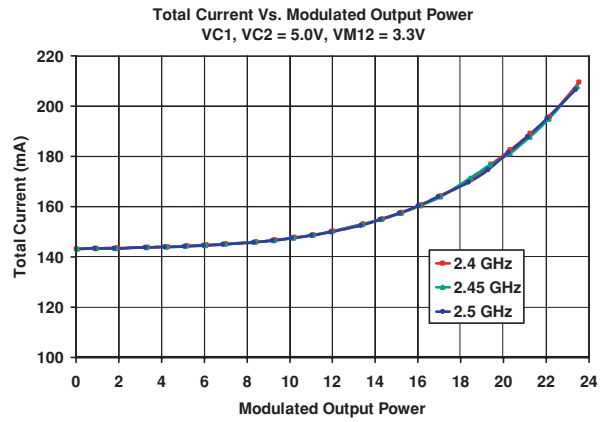
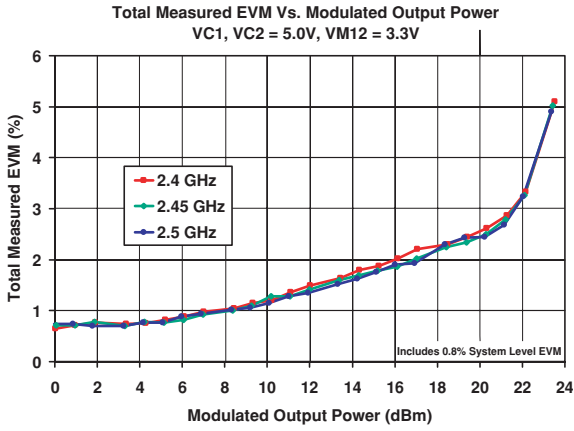

## Performance Data 802.11g OFDM

Modulation (with 176 ms burst time, 100 ms idle time) 54 Mbps Data Rate, 16.7 MHz Bandwidth

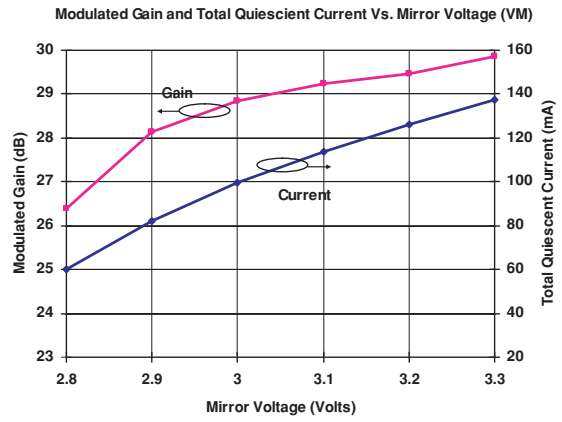
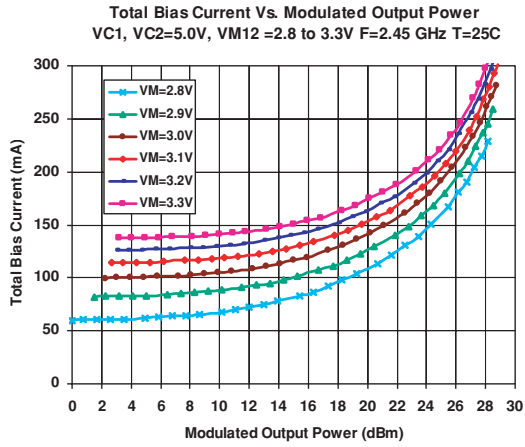

## Single Tone

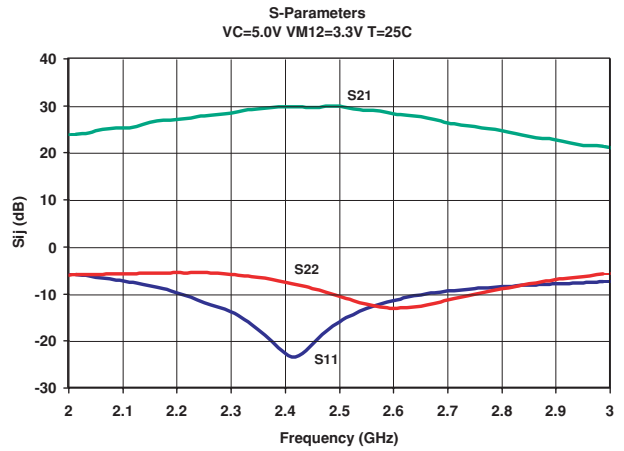
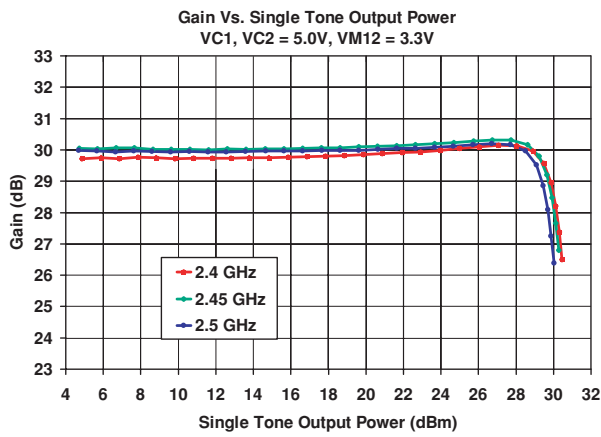

## Evaluation Board Schematic

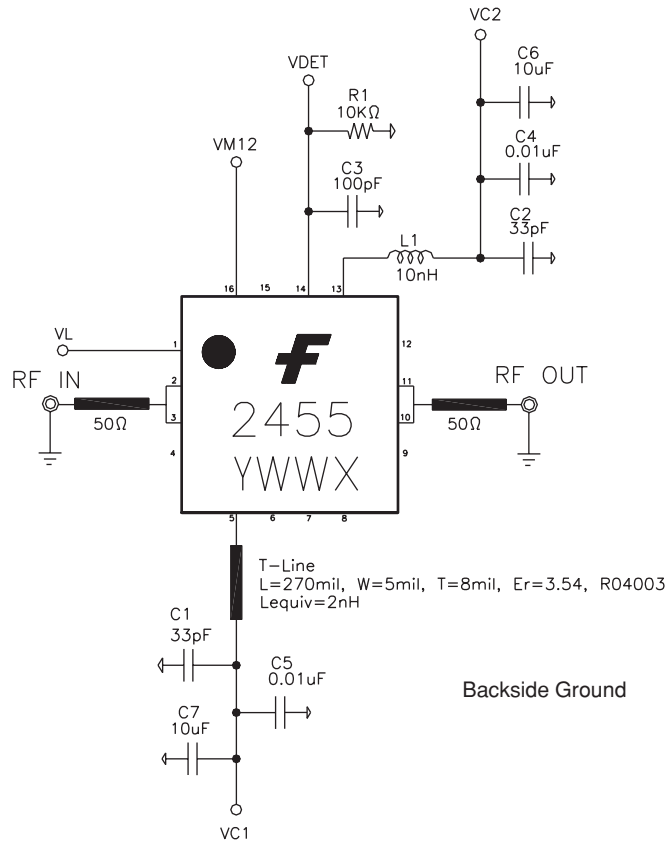

## Package Outline

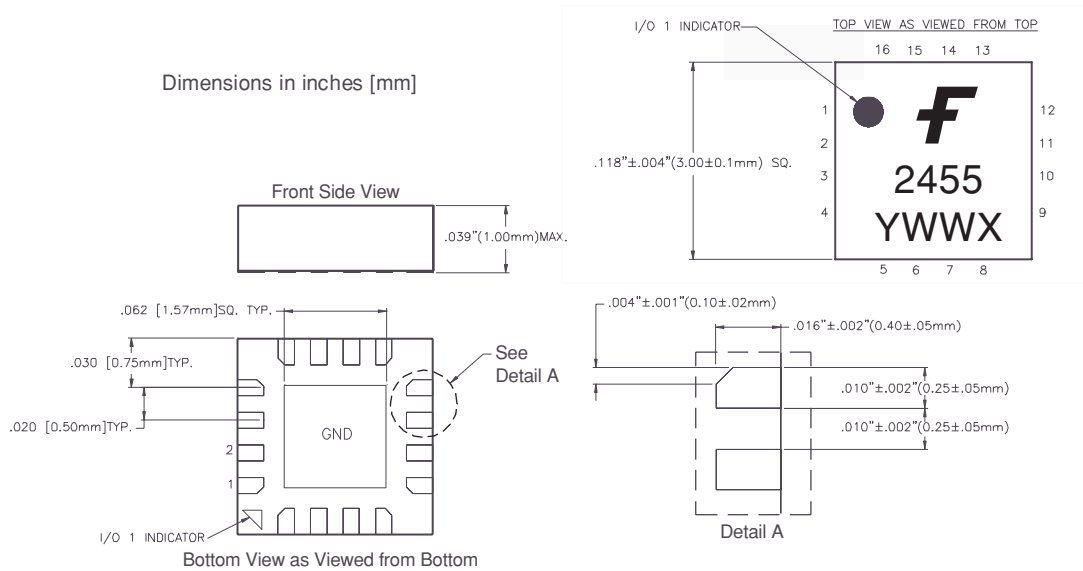

**Note:** Dimensions do not include protrusions or mold flash. These are not to exceed 0.006" (.155mm) on any side.

## Evaluation Board of Materials

### MATERIALS LIST

QTY	ITEM NO.	PART NUMBER	DESCRIPTION	VENDOR
1	1	G657429	PC, BOARD	FAIRCHILD
2	2	#142-0701-841	SMA CONNECTOR	JOHNSON
6	3	#S1322-XX-ND	RT ANGLE SGL M HEADER	DIGIKEY
REF	4	F100046	ASSEMBLY, RMPA2455	FAIRCHILD
2	5 (C1&C2)	GRM39C0G330J50V	33 pF CAPACITOR	MURATA
1	6 (C3)	GRM36C0G101J50V	100 pF CAPACITOR	MURATA
2	7 (C4&C5)	GRM39X7R103K50V	.01 uF CAPACITOR	MURATA
2	8 (C6&C7)	CC1206JX5R106M	10 uF CAPACITOR (6.3V)	TDK
1	9 (L1)	LLV1005FB10NJ	10 nH INDUCTOR	TDKO
1	10 (R1)	RCI-0402-1002J	10K OHM RESISTOR	IMS
A/R	11	SN63	SOLDER PASTE	INDIUM CORP
A/R	12	SN96	SOLDER PASTE	INDIUM CORP

## Evaluation Board Layout

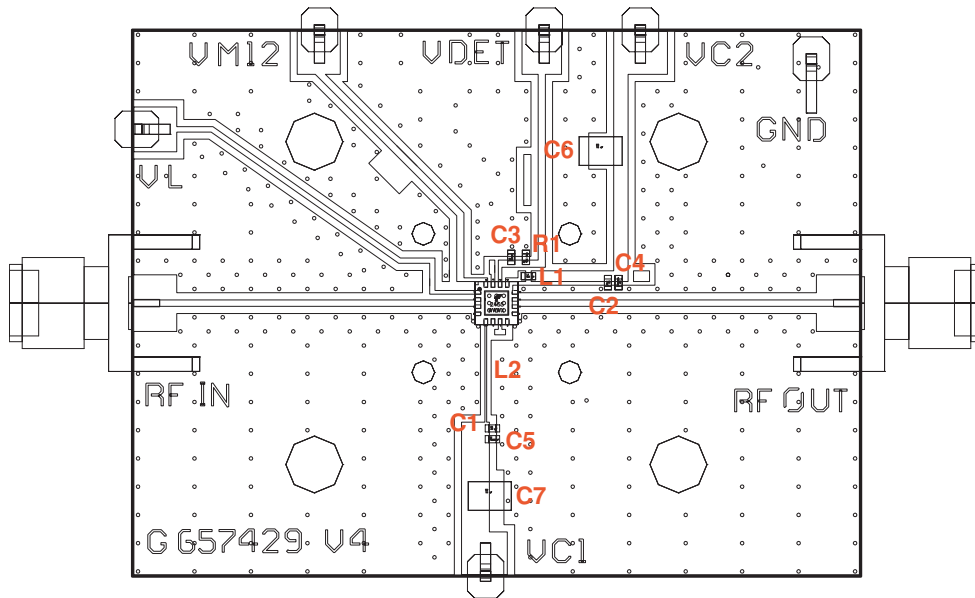

Actual Board Size = 2.0" X 1.5"

## Evaluation Board Turn-On Sequence<sup>1</sup>

### Recommended turn-on sequence:

- 1) Connect common ground terminal to the Ground (GND) pin on the board.
- 2) Apply low voltage 0.0 to +1.0 V to pin  $V_L$ .
- 3) Apply positive supply voltage VC1 (= 5.0V) to pin VC1 (first stage collector).
- 4) Apply positive supply voltage VC2 (= 5.0V) to pin VC2 (second stage collector).
- 5) Apply positive bias voltage VM12 (= 3.3V) to pin VM12 (bias networks).
- 6) At this point, you should expect to observe the following positive currents flowing into the pins:

Pin	Current
VM12	15.0 – 20.0 mA
VC1	45.0 – 65.0 mA
VC2	60.0 – 80.0 mA
$V_L$	<1 nA

7) Apply input RF power to SMA connector pin RFIN. Currents in pins VC1 and VC2 will vary depending on the input drive level.

8) Vary positive voltage  $V_L$  on pin VREG from +0.5V to +2.4V to shut down the amplifier or alter the power level. Shut down current flow into the pins:

Pin	Current
VM12	<0.7 mA
VC1	<1 nA
VC2	<1 nA
$V_L$	<0.25 mA

### Recommended turn-off sequence:

Use reverse order described in the turn-on sequence above.

#### Note:

1. Turn on sequence is not critical and it is not necessary to sequence power supplies in actual system level design.



## TRADEMARKS

The following are registered and unregistered trademarks Fairchild Semiconductor owns or is authorized to use and is not intended to be an exhaustive list of all such trademarks.

ACEx™	FAST®	IntelliMAX™	POP™	SPM™
ActiveArray™	FASTr™	ISOPLANAR™	Power247™	Stealth™
Bottomless™	FPS™	LittleFET™	PowerEdge™	SuperFET™
CoolFET™	FRFET™	MICROCOUPLER™	PowerSaver™	SuperSOT™-3
CROSSVOLT™	GlobalOptoisolator™	MicroFET™	PowerTrench®	SuperSOT™-6
DOME™	GTO™	MicroPak™	QFET®	SuperSOT™-8
EcoSPARK™	HiSeC™	MICROWIRE™	QS™	SyncFET™
E <sup>2</sup> CMOS™	PC™	MSX™	QT Optoelectronics™	TinyLogic®
EnSigna™	i-Lo™	MSXPro™	Quiet Series™	TINYOPTO™
FACT™	ImpliedDisconnect™	OCX™	RapidConfigure™	TruTranslation™
FACT Quiet Series™		OCXPro™	RapidConnect™	UHC™
Across the board. Around the world.™		OPTOLOGIC®	µSerDes™	UltraFET®
The Power Franchise®		OPTOPLANAR™	SILENT SWITCHER®	UniFET™
Programmable Active Droop™		PACMAN™	SMART START™	VCX™

## DISCLAIMER

FAIRCHILD SEMICONDUCTOR RESERVES THE RIGHT TO MAKE CHANGES WITHOUT FURTHER NOTICE TO ANY PRODUCTS HEREIN TO IMPROVE RELIABILITY, FUNCTION OR DESIGN. FAIRCHILD DOES NOT ASSUME ANY LIABILITY ARISING OUT OF THE APPLICATION OR USE OF ANY PRODUCT OR CIRCUIT DESCRIBED HEREIN; NEITHER DOES IT CONVEY ANY LICENSE UNDER ITS PATENT RIGHTS, NOR THE RIGHTS OF OTHERS.

## LIFE SUPPORT POLICY

FAIRCHILD'S PRODUCTS ARE NOT AUTHORIZED FOR USE AS CRITICAL COMPONENTS IN LIFE SUPPORT DEVICES OR SYSTEMS WITHOUT THE EXPRESS WRITTEN APPROVAL OF FAIRCHILD SEMICONDUCTOR CORPORATION. As used herein:

1. Life support devices or systems are devices or systems which, (a) are intended for surgical implant into the body, or (b) support or sustain life, or (c) whose failure to perform when properly used in accordance with instructions for use provided in the labeling, can be reasonably expected to result in significant injury to the user.
2. A critical component is any component of a life support device or system whose failure to perform can be reasonably expected to cause the failure of the life support device or system, or to affect its safety or effectiveness.

## PRODUCT STATUS DEFINITIONS

### Definition of Terms

Datasheet Identification	Product Status	Definition
Advance Information	Formative or In Design	This datasheet contains the design specifications for product development. Specifications may change in any manner without notice.
Preliminary	First Production	This datasheet contains preliminary data, and supplementary data will be published at a later date. Fairchild Semiconductor reserves the right to make changes at any time without notice in order to improve design.
No Identification Needed	Full Production	This datasheet contains final specifications. Fairchild Semiconductor reserves the right to make changes at any time without notice in order to improve design.
Obsolete	Not In Production	This datasheet contains specifications on a product that has been discontinued by Fairchild semiconductor. The datasheet is printed for reference information only.

Rev. 115