



- 10/100/1000 Base-T Gigabit for Ethernet Applications
- Can be used side by side for 2X2 applications
- RJ45 jack cavity conforms to FCC rules and regulations Part 68, SUB Part F
- Industrial Operating Temp: -40°C to +85°C
- Contact Factory for Standard Temp.
- Available in other Circuit Designs
- Optional Gold Plating Thickness
- Other LED Patterns available



Electrical Specifications @ 25°C

Part Number	OCL(uH Min) @ 100kHz, 0.1V	Turns Ratio chip: cable (±2%)	Insertion Loss (dB Max)	Return Loss (dB Min)		
	With 8mA DC Bias		1-100MHz	1-30MHz	30-60MHz	60-80MHz
AR21-3688I	350	1:1	-1.0	-18	-18-20Log(F/30MHz)	-12

Electrical Specifications @ 25°C

Cross Talk (dB Min)					CMR (dB Min)					CDMR (dB Min)					HI-POT (Vrms) 0.5mA/2Sec.
0.5-1MHz	10MHz	30MHz	50MHz	100MHz	0.3-1MHz	10MHz	30MHz	60MHz	100MHz	0.3-1MHz	10MHz	30MHz	60MHz	100MHz	
-50	-50	-40	-35	-30	-50	-47	-42	-37	-30	-50	-50	-50	-45	-40	1500

All specifications subject to change without notice.

MECHANICAL

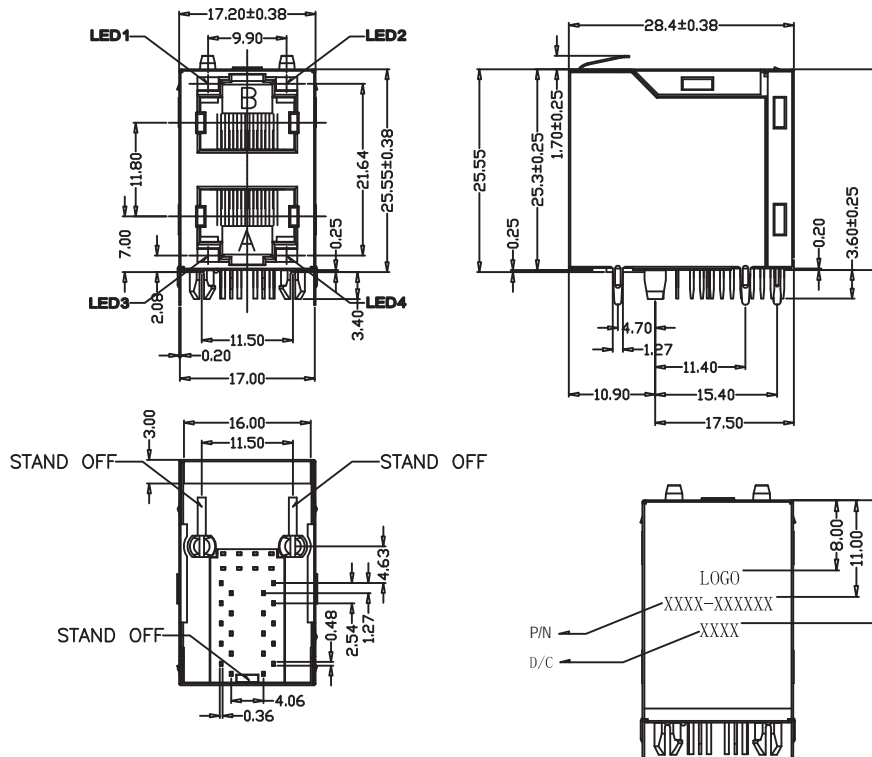

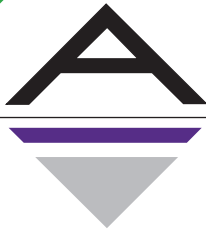

SCHEMATICS

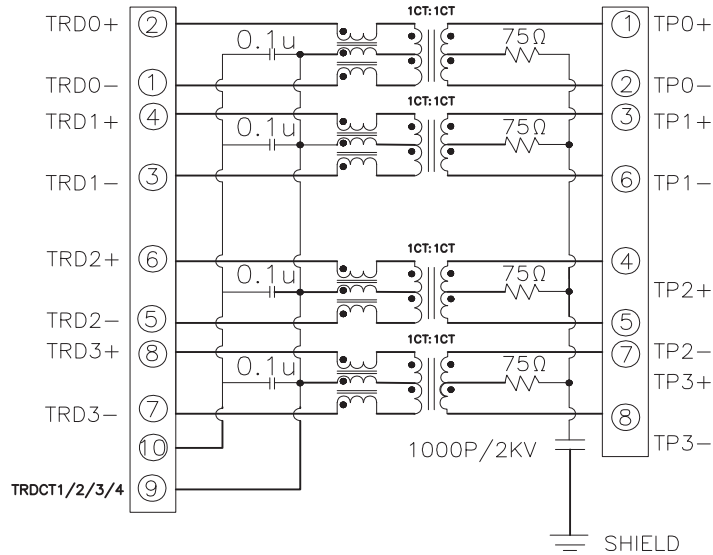

PCB LAYOUT

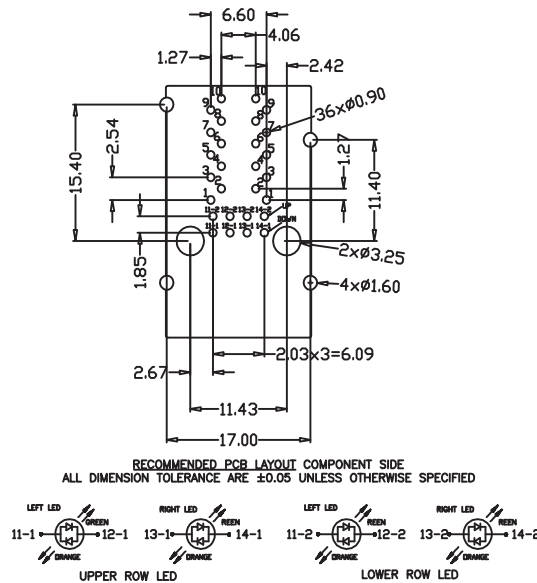

NOTES

1. Shield- 0.20mm THICKNESS BRASS C2680 H. PLATING NICKEL 30u"-50u"
2. Housing- Standard Material Nylon66, Glass filled Polyester UL94V-0 Standard Color Black.
3. RJ Terminal- Plastic: Nylon 66, UL94V-0, Standard Color Black.
Pin: 0.35mm Thickness Phos-Bronze C5210 EH. Plating: Nickel 40u"-60u" for all and Sn 100%, and 50u" Gold Plating.
4. Input Terminal: Nylon66, Glass Filled, UL94V-0, Standard Color Black.
Pin: 0.35mm Thickness Phos-Bronze C5191. Plating: Nickel 40u"-60u" for all and Sn 100%.