

Bandpass Filter 241251B



1. Features

- IF bandpass filter
- Low-Loss Filter
- Single-ended operation
- Ceramic Surface Mount Device(SMD) Package
- Maximum Storage Temperature Range : -40℃ ~ 85℃
- Electrostatics Sensitive Device (ESD)

2. Package Dimension

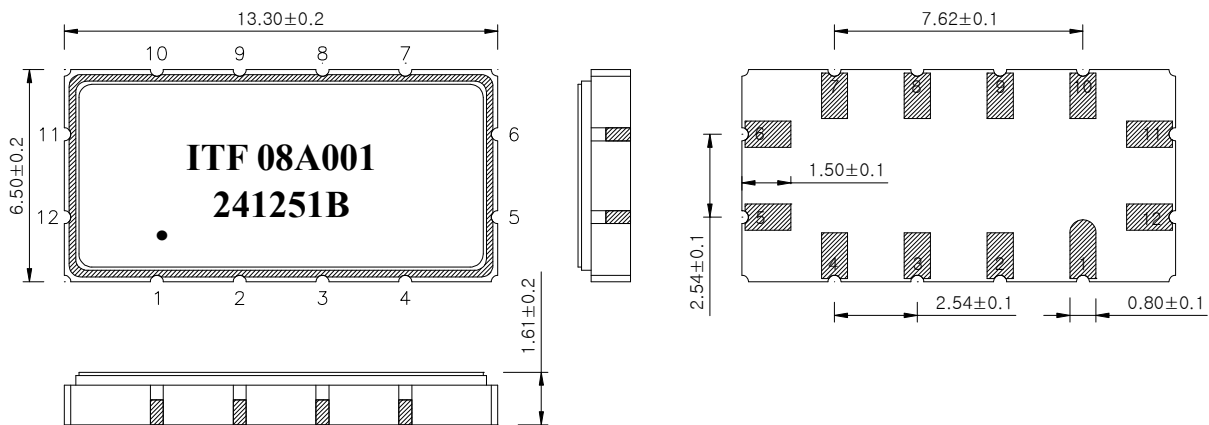

Package : S1365

Dimensions shown are nominal in millimeters

Body : Al₂O₃

Lid : Kovar, Ni Plated

Termination : Au plating 0.3 ~ 1.0um, over a 1.27 ~ 8.89um Ni Plating

Pin Configuration	
11	Input
5	Output
6, 12	Ground
Other	Case ground

	ITF Co., Ltd. 102-901, Bucheon Technopark 364, Samjeong-Dong, Ojeong-Gu, Bucheon-City, Gyeonggi-Do, Korea 421-809	Part No.	241251B	
		Rev. Date	2008-10-31	
		Rev.	NJ8021-CS01	1/5

Bandpass Filter 241251B



3. Specifications

F_o = 80.5 MHz

Terminating source impedance : 50Ω and matching network

Terminating load impedance : 50Ω and matching network

Operating temperature range : -30℃ ~ +85℃		Minimum	Typical	Maximum
Center Frequency (F _c)	MHz	-	80.5	-
Insertion Loss	dB	-	11.0	14.0
1dB Bandwidth	MHz	11.0	11.61	-
3dB Bandwidth	MHz	-	12.4	-
40dB Bandwidth	MHz	-	15.7	16.2
Amplitude Ripple (F _o +/- 4.375 MHz)	dB	-	0.35	1.0
Group Delay Variation (F _o +/- 4.375 MHz)	nsec	-	40	70
Absolute Delay	usec	-	0.92	-
Ultimate Rejection	dB	38	43	-
Temperature Coefficient of Frequency (TCF)	ppm/℃	-	- 86	-

Room temperature : + 25 ℃		Minimum	Typical	Maximum
Insertion Loss	dB	-	11.0	13.5
Amplitude Ripple (F _o +/- 4.775 MHz)	dB	-	0.35	1.0
Group Delay Variation (F _o +/- 4.775 MHz)	nsec	-	40	70
Relative Attenuation				
F _c - 75.0 MHz	dB	75	80	-
F _c - 50.0 MHz	dB	65	70	-
F _c + 50.0 MHz	dB	55	60	-
F _c + 75.0 MHz	dB	55	60	-
F _c + 90.0 MHz	dB	40	45	-

	ITF Co., Ltd. 102-901, Bucheon Technopark 364, Samjeong-Dong, Ojeong-Gu, Bucheon-City, Gyeonggi-Do, Korea 421-809	Part No.	241251B	
		Rev. Date	2008-10-31	
		Rev.	NJ8021-CS01	2/5

Bandpass Filter 241251B



Notes :

- 1) All specifications are based on the matching schematic shown below
- 2) All specifications are measured by Agilent Network analyzer and full 2 port calibration
- 3) Electrical margin has been built into the design to account for the variations due to temperature drift and manufacturing tolerances
- 4) All attenuation measurements are measured relative to insertion loss

4. Matching Schematic

(Actual matching values may vary due to PCB layout and parasitics)

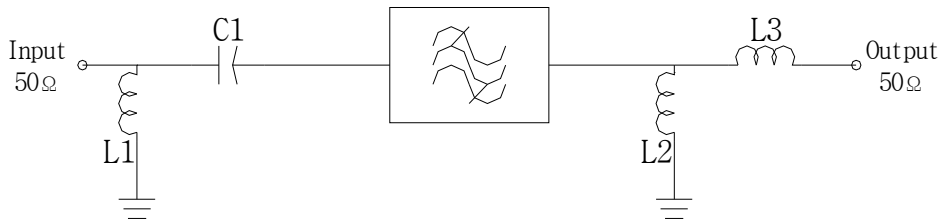

L1 = 150 nH, C1 = 130 pF
 L2 = 56 nH, L3 = 82 nH

5. Marking Configuration

ITF¹⁾08A001²⁾

241251B³⁾

●⁴⁾

- 1) Manufacturer name
- 2) Lot Number
- 3) Part Number
- 4) Pad Number 1 Index

	ITF Co., Ltd. 102-901, Bucheon Technopark 364, Samjeong-Dong, Ojeong-Gu, Bucheon-City, Gyeonggi-Do, Korea 421-809	Part No.	241251B	
		Rev. Date	2008-10-31	
		Rev.	NJ8021-CS01	3/5

Bandpass Filter 241251B



6. Typical Performance (at +25°C)

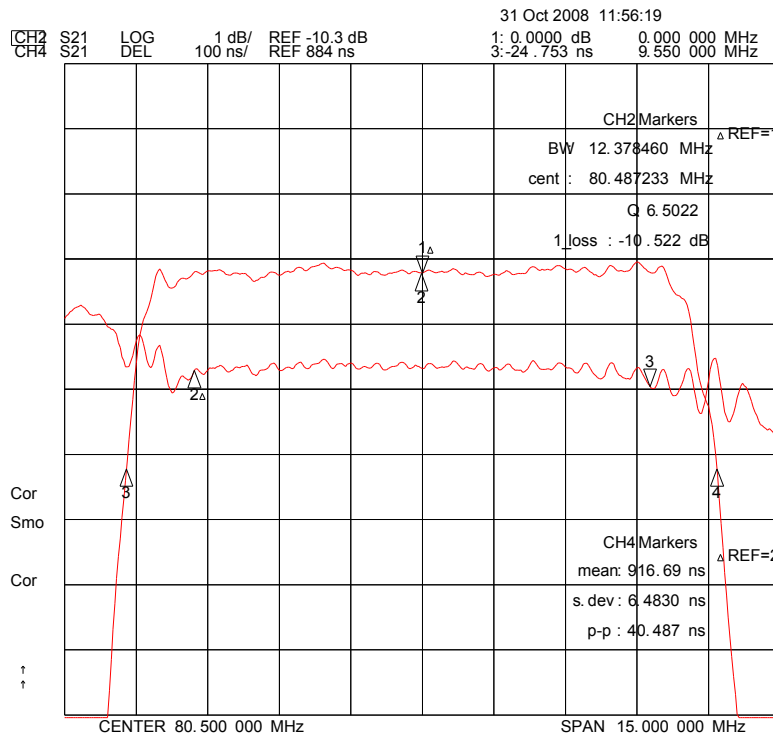
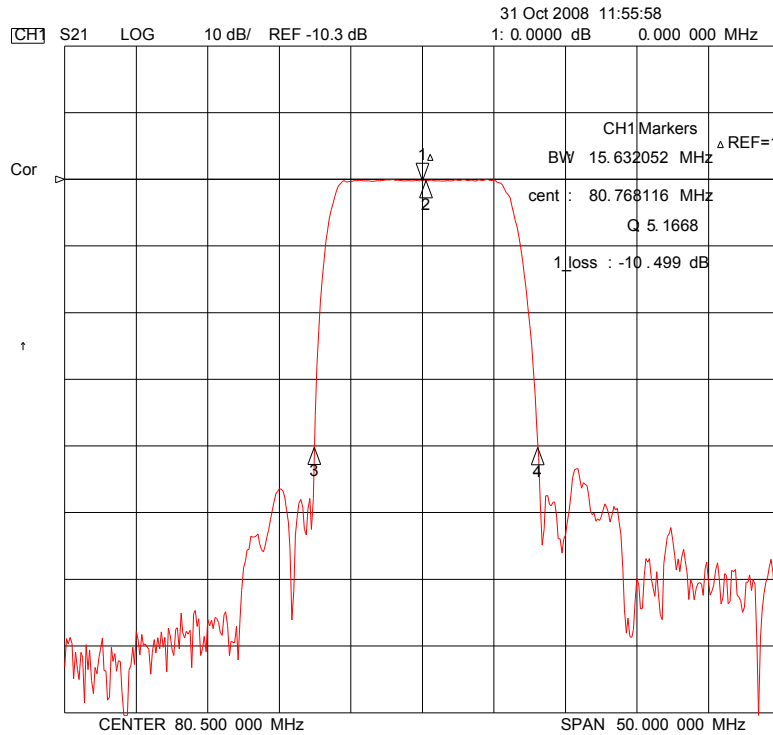

ITF Co., Ltd.
 102-901, Bucheon Technopark 364,
 Samjeong-Dong, Ojeong-Gu, Bucheon-City,
 Gyeonggi-Do, Korea 421-809

Part No.	241251B	
Rev. Date	2008-10-31	
Rev.	NJ8021-CS01	4/5

Bandpass Filter 241251B

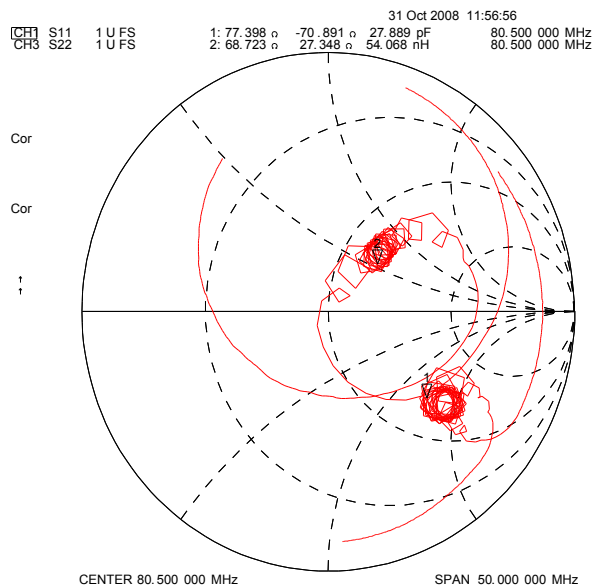
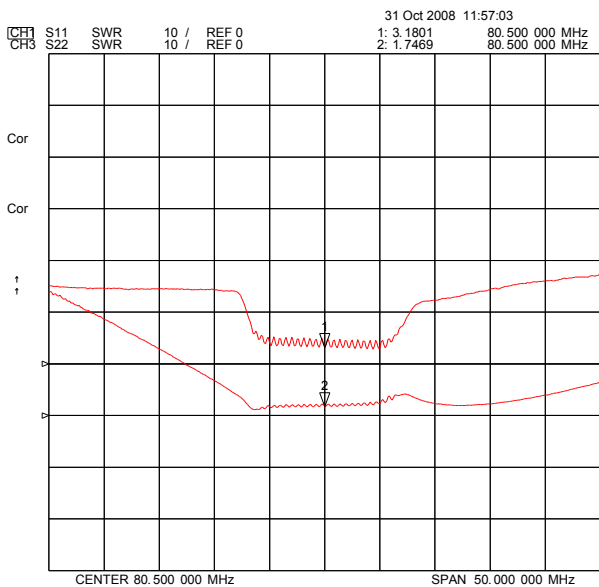
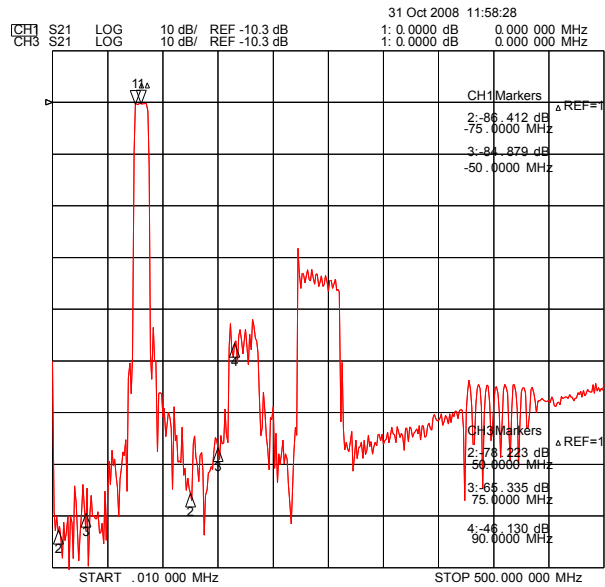
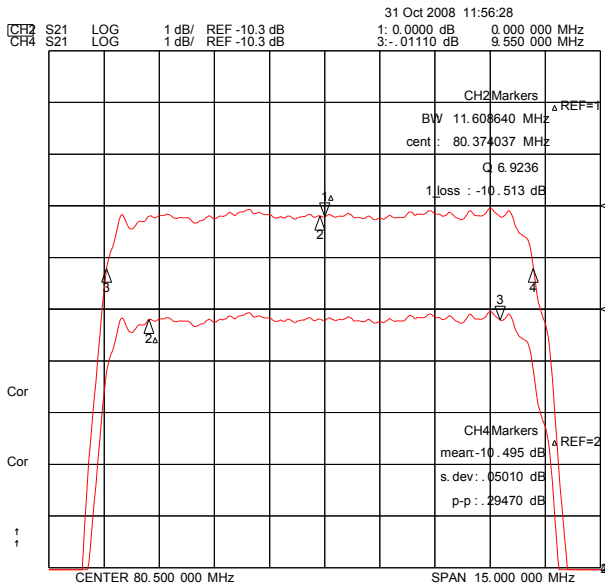

ITF Co., Ltd.
 102-901, Bucheon Technopark 364,
 Samjeong-Dong, Ojeong-Gu, Bucheon-City,
 Gyeonggi-Do, Korea 421-809

Part No.	241251B	
Rev. Date	2008-10-31	
Rev.	NJ8021-CS01	5/5