



- Features :
 - Universal AC input / Full range
 - Built-in active PFC function, PF>0.95
 - Protections: Short circuit / Overload / Over voltage
 - Power good and fail signal
 - FAN speed control function
 - Power ON-OFF switch with indicator
 - Forced air cooling by built-in DC fan
 - 100% full load burn-in test
 - Approvals: UL / CUL / TUV / CB / FCC / CE
 - 2 years warranty



SPECIFICATION

ORDER NO.	YP-350J-AA							
OUTPUT	SAFETY MODEL NO.	YP-350J						
	CHANNEL	CH1	CH2	CH3	CH4	CH5	CH6	STANDBY
	DC VOLTAGE	3.3V	5V	12V	24V	-5V	-12V	5VSB
	MINIMUM CURRENT	0.3A	0.1A	0A	0A	0A	0A	0A
	RATED CURRENT	9A	15A	9A	5A	0.3A	0.8A	2.0A
	MAXIMUM CURRENT	14A	21A	15A	5A	0.3A	0.8A	2.0A
	COMBINE LOAD	135W max. For +5V and +3.3V output 210W max. For +5V, +3.3V and +12V output						
	RATED POWER (max.)	350W continue load						
	RIPPLE & NOISE (max.) Note.2	50mVp-p	50mVp-p	120mVp-p	150mVp-p	100mVp-p	120mVp-p	50mVp-p
	LINE REGULATION	±1.0%	±1.0%	±1.0%	±1.0%	±2.0%	±2.0%	±1.0%
	LOAD REGULATION Note.3	±5.0%	±5.0%	-2.0 ~ +8.0%	-2.0 ~ +8.0%	±5.0%	±10%	±5.0%
HOLD UP TIME	10ms min. at full load (Rated current)							
INPUT	VOLTAGE RANGE	100 ~ 264VAC						
	FREQUENCY RANGE	47 ~ 63Hz						
	POWER FACTOR	PF>0.95@230VAC PF>0.98@115VAC						
	EFFICIENCY (Typ.)	70%						
	AC CURRENT	8.0A / 115VAC 4.5A / 230VAC						
	INRUSH CURRENT (max.)	40A / 115VAC 80A / 230VAC						
LEAKAGE CURRENT	3.5mA / 240VAC							
PROTECTION	OVERLOAD	105 ~ 180% rated output power Protection type : Shut down o/p voltage, re-power on to recover						
	OVER VOLTAGE	110% ~ 130% of rated voltage for +3.3V, +5V and +12V Protection type : Shut down o/p voltage, re-power on to recover						
	SHORT CIRCUIT	All output equipped with short circuit Protection type : Shut down o/p voltage, re-power on to recover						
FUNCTION	POWER GOOD SIGNAL	The TTL compatible signal out with 100ms to 500ms delay after power set up						
	POWER FAIL SIGNAL	The TTL compatible signal will go down at least 1ms before +5V below 4.75V						
	PS-ON INPUT SIGNAL	Power on: PS-ON = "Low" or "<0.8V"; Power off: PS-ON = "Hi" or ">2V"						
ENVIRONMENT	WORKING TEMP.	-10 ~ +40°C						
	WORKING HUMIDITY	20 ~ 90% RH non-condensing						
	STORAGE TEMP., HUMIDITY	-20 ~ +85°C, 10 ~ 95% RH						
	TEMP. COEFFICIENT	±0.05% / °C (0 ~ 50°C)						
	VIBRATION	10 ~ 200Hz, 2G 10min./1cycle, 60min. each along X, Y, Z axes						
SAFETY & EMC (Note 4)	SAFETY STANDARDS	UL60950-1, TUV EN60950-1 approved						
	WITHSTAND VOLTAGE	I/P-O/P:1.5KVAC						
	ISOLATION RESISTANCE	I/P-O/P: 50M Ohms / 500VDC / 25°C / 70% RH						
	EMI CONDUCTION & RADIATION	Compliance to EN55022 (CISPR22) class B, FCC part 15 Class B						
	HARMONIC CURRENT	Compliance to EN61000-3-2,-3						
OTHERS	EMS IMMUNITY	Compliance to EN61000-4-2,3,4, 5,6,8,11, light industry level, criteria A						
	MTBF	100K hrs min.						
	CONNECTOR	ATX main power connector * 1ea; +12V power connector * 1ea; Auxiliary power connector * 1ea Peripheral power connector * 5 ea; Floppy drive power connector * 2 ea						
	COOLING	Forced air ventilation by 8cmx8 ball bearing DC fan						
	DIMENSION	171*150*86mm (L*W*H)						
PACKING	1.6Kg ; 12pcs / 20Kg / CARTON							
NOTE	<ol style="list-style-type: none"> 1. All parameters NOT specially mentioned are measured at 230VAC input, rated load and 25°C of ambient temperature. 2. Ripple & noise are measured at 20MHz of bandwidth by using a 12" twisted pair-wire terminated with a 0.1uf & 47uf parallel capacitor. 3. Line regulation is measured from low line to high line at rated load. 4. Load regulation is measured from 20% to 100% max. Load. 5. The power supply is considered a component which will be installed into a final equipment. The final equipment must be re-confirmed that it still meets EMC directives. 							

Mechanical Specification

Unit: mm

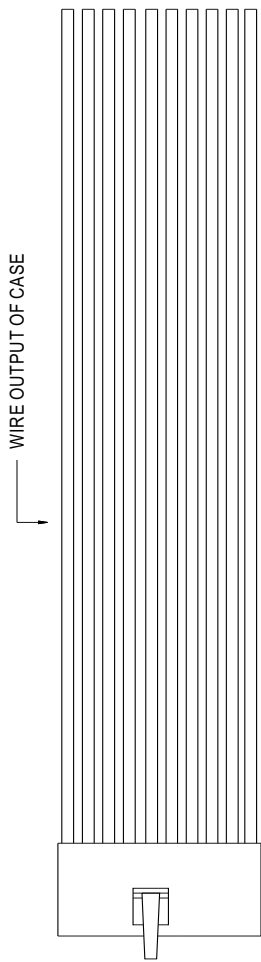
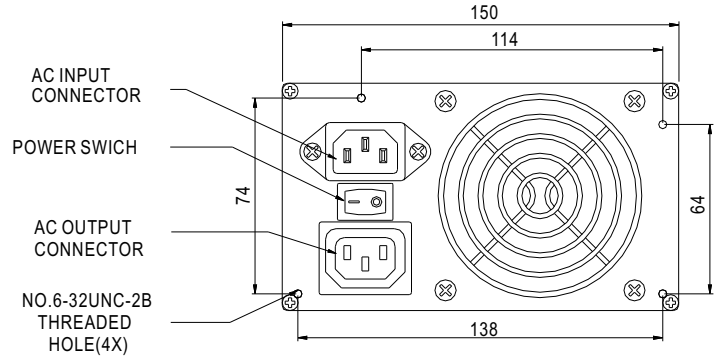
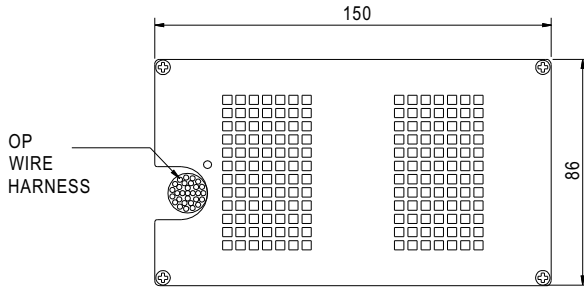

L=400mm ± 50mm

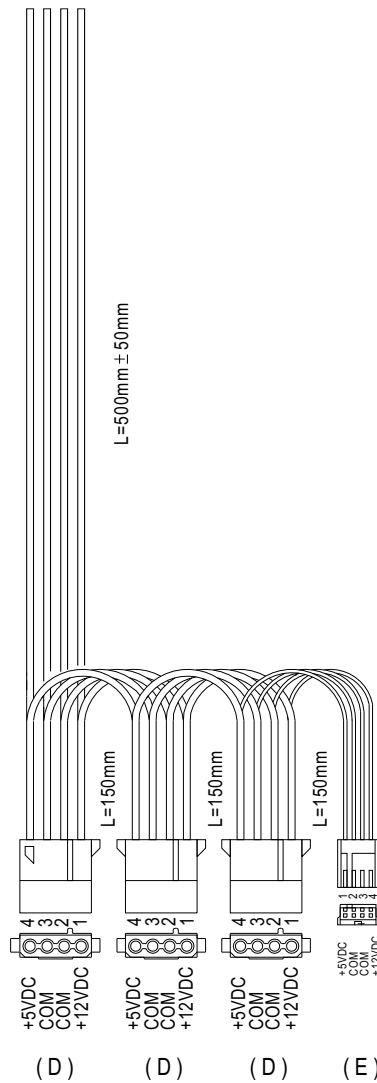

(D)

(D)

(D)

(E)

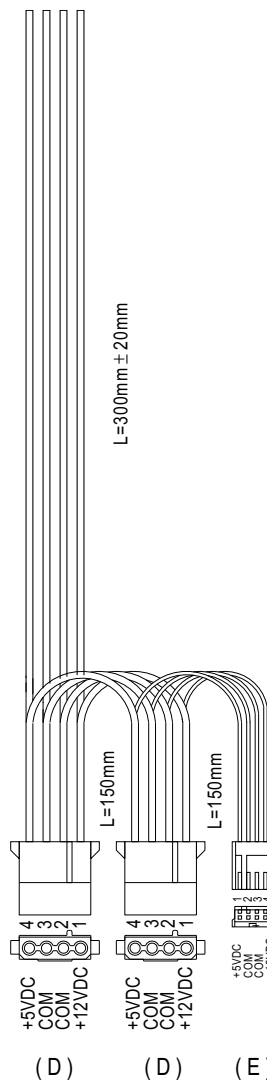

(D)

(D)

(E)

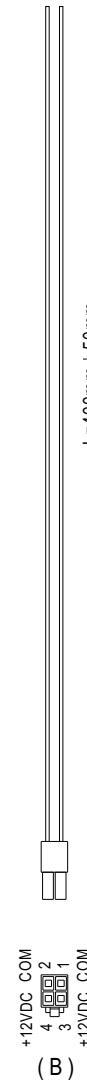

L=400mm ± 50mm

+12VDC COM
4 3 2 1
+12VDC COM

(B)

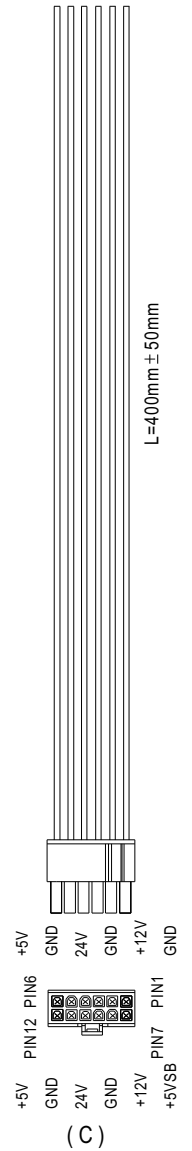

L=400mm ± 50mm

+5V GND 24V GND +12V GND
+5V PIN12 PIN6
+12V PIN7 PIN1
+5VSB

(C)

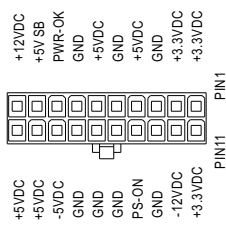

(A)

(A) ATX main power connector
Type: MOLEX 39-01-2200 or equivalent

(C) Auxiliary power connector
Type: MOLEX 39-01-2120 or equivalent

(E) Floppy drive connector
Type: AMP 171822-4 or equivalent

(B) +12V power connector
Type: MOLEX 39-01-2040 or equivalent

(D) Peripheral connector
Type: MOLEX 8981-04P or equivalent