



# MAXIM

## 330MHz Buffered Video Switches/ Crosspoint Building Blocks

### General Description

The MAX4111/MAX4121/MAX4221 wideband video switches are optimized for high-definition, broadcast-quality, composite (HDTV, NTSC, PAL, SECAM, and RGB) video switching arrays. Their open-loop buffer amplifiers offer 0.1dB gain flatness to 150MHz. They operate from  $\pm 5V$  supplies and feature differential phase and gain error of only 0.01%/0.01%, respectively. The ultra-low switching glitch (13mV) is positive to avoid confusion with any sync pulse.

Ideal as building blocks in large arrays, these devices feature a constant, high input impedance and a disable function that puts the outputs into a high-impedance state and reduces the operating current to only 250 $\mu A$ . The open-loop architecture allows the outputs to drive capacitive loads without oscillation. Other key features include -92dB crosstalk and -78dB isolation (MAX4121).

The MAX4111/MAX4121/MAX4221 are offered in narrow plastic DIP and SO packages. See the table below for key features:

PART	DESCRIPTION	PINS
MAX4111	SPST, single-input, single-output switch	8
MAX4121	SPDT, 2-input, single-output switch	8
MAX4221	Dual, SPDT, 2-input, single-output switch	16

### Applications

- Video-Router and Crosspoint Arrays
- Broadcast/HDTV-Quality Color Signal Multiplexing
- RF and IF Routing
- Graphics Color-Signal Routing
- Telecom Routing
- Data Acquisition

### Features

- ◆ -3dB Bandwidth of 330MHz
- ◆ 0.1dB Gain Flatness of 150MHz
- ◆ 700V/ $\mu s$  Slew Rate
- ◆ 0.01%/0.01% Differential Phase/Gain
- ◆ Low Power: 5.5mA Max
- ◆ -92dB Crosstalk and -78dB Off Isolation at 30MHz
- ◆ High-Z Outputs when Disabled
- ◆ 3pF Input Capacitance
- ◆ Ultra-Low Switching Glitch
- ◆ On-Board Control Logic

### Ordering Information

PART	TEMP. RANGE	PIN-PACKAGE
MAX4111CSA	0°C to +70°C	8 SO
MAX4121CSA	0°C to +70°C	8 SO
MAX4221CSE	0°C to +70°C	16 Narrow SO

### Pin Configurations/Functional Diagrams

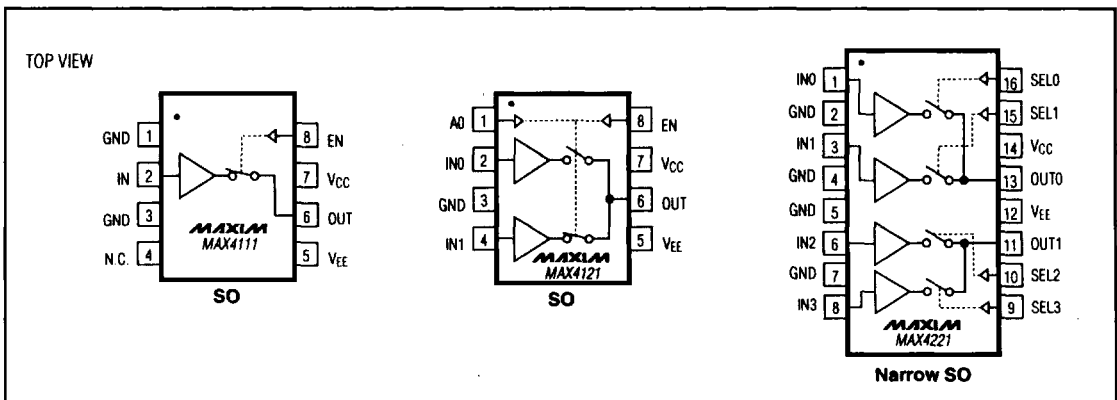

**MAXIM**

Maxim Integrated Products 8-19

Call toll free 1-800-998-8800 for free samples or literature.

MAX4111/MAX4121/MAX4221

# 330MHz Buffered Video Switches/ Crosspoint Building Blocks

## ABSOLUTE MAXIMUM RATINGS

Supply Voltages		Continuous Power Dissipation (T <sub>A</sub> = +70°C)	
V <sub>CC</sub> .....	+6V	8-Pin SO (derate 5.88mW/°C above +70°C).....	471mW
V <sub>EE</sub> .....	-6V	16-Pin Narrow SO (derate 8.70mW/°C above +70°C) ..	696mW
V <sub>CC-VEE</sub> .....	+12V	Operating Temperature Range .....	0°C to +70°C
Analog Input Voltage .....	(V <sub>EE</sub> - 0.3V) to (V <sub>CC</sub> + 0.3V)	Storage Temperature Range .....	-65°C to +160°C
Digital Input Voltage .....	-0.3V to (V <sub>CC</sub> + 0.3V)	Junction Temperature .....	+150°C
Duration of Short Circuit to Ground .....	Continuous	Lead Temperature (soldering, 10sec) .....	+300°C

Stresses beyond those listed under "Absolute Maximum Ratings" may cause permanent damage to the device. These are stress ratings only, and functional operation of the device at these or any other conditions beyond those indicated in the operational sections of the specifications is not implied. Exposure to absolute maximum rating conditions for extended periods may affect device reliability.

## ELECTRICAL CHARACTERISTICS

(V<sub>S</sub> = ±5V, -2.5V ≤ V<sub>IN</sub> ≤ +2.5V, R<sub>L</sub> = 5kΩ, C<sub>L</sub> ≤ 5pF, T<sub>A</sub> = 0°C to +70°C, unless otherwise noted. Typical values are at T<sub>A</sub> = +25°C.)

PARAMETER	SYMBOL	CONDITIONS	MIN	TYP	MAX	UNITS	
<b>DC PARAMETERS</b>							
Operating Supply Voltage	V <sub>S</sub>		±4.5	±5.0	±5.5	V	
Operating Supply Current	I <sub>CC, IEE</sub>	Per channel	T <sub>A</sub> = +25°C		4.0	5.5	mA
			T <sub>A</sub> = T <sub>MIN</sub> to T <sub>MAX</sub>		6.5		
Disabled Supply Current	I <sub>CC, IEE</sub>	MAX4111/MAX4121			150	200	µA
		MAX4221			250	350	
Input Voltage Range	V <sub>IN</sub>		±2.5			V	
Input Bias Current	I <sub>B</sub>	V <sub>IN</sub> = 0V	Channel selected		±2.5	±4.0	µA
			Channel disabled		±0.02		
Input Resistance	R <sub>IN</sub>	Channel selected		0.4		MΩ	
		Channel disabled		100			
Input Capacitance	C <sub>IN</sub>	V <sub>IN</sub> = 0V, channel enabled or disabled		3		pF	
Output Offset Voltage	V <sub>OS</sub>	T <sub>A</sub> = +25°C		±5	±10	mV	
		T <sub>A</sub> = T <sub>MIN</sub> to T <sub>MAX</sub>		±15			
Power-Supply Rejection Ratio	PSRR	V <sub>S</sub> = ±4.5V to ±5.5V		50		dB	
Voltage Gain	A <sub>V</sub>	V <sub>IN</sub> = ±2.5V	T <sub>A</sub> = +25°C		0.98	1.0	V/V
			T <sub>A</sub> = T <sub>MIN</sub> to T <sub>MAX</sub>		0.97	1.0	
Output Resistance	R <sub>OUT</sub>	f = DC to 50MHz		20		Ω	
Disabled Output Current	I <sub>OUT(OFF)</sub>	V <sub>OUT</sub> = 0V		10		nA	
Disabled Output Resistance	R <sub>OUT(OFF)</sub>			30		MΩ	
Disabled Output Capacitance	C <sub>OUT(OFF)</sub>			5		pF	
Logic Input High Voltage	V <sub>INH</sub>	V <sub>S</sub> = ±4.5V to ±5.5V		2.0		V	
Logic Input Low Voltage	V <sub>INL</sub>	V <sub>S</sub> = ±4.5V to ±5.5V		0.8		V	
Logic Input High Current	I <sub>INH</sub>	V <sub>S</sub> = ±4.5V to ±5.5V		10		µA	
Logic Input Low Current	I <sub>INL</sub>	V <sub>S</sub> = ±4.5V to ±5.5V		10		µA	

# 330MHz Buffered Video Switches/ Crosspoint Building Blocks

**MAX4111/MAX4121/MAX4221**

## ELECTRICAL CHARACTERISTICS

( $V_S = \pm 5V$ ,  $-2.5V \leq V_{IN} \leq +2.5V$ ,  $R_L = 5k\Omega$ ,  $C_L \leq 5pF$ ,  $T_A = 0^\circ C$  to  $+70^\circ C$ , unless otherwise noted. Typical values are at  $T_A = +25^\circ C$ .)

PARAMETER	SYMBOL	CONDITIONS	MIN	TYP	MAX	UNITS
<b>AC PARAMETERS</b>						
Slew Rate	SR	$V_{OUT} = 5Vp-p$		700		V/ $\mu s$
		$V_{OUT} = 1.4Vp-p$		500		
Full-Power Bandwidth (Note 1)	FPBW	$V_{IN} = 1.4Vp-p$		110		MHz
		$V_{IN} = 5Vp-p$		45		
-3dB Bandwidth	$f_{3dB}$	$V_{IN} = 0.1Vp-p$		330		MHz
Gain Flatness		DC to 30MHz		0.02		dB
		DC to 150MHz		0.1		
Gain Peaking				0.08		dB
Small-Signal Rise Time	$t_r/t_f$	$V_{IN} = 0.1Vp-p$		950		ps
Differential Gain (Note 2)	DG	$f = 3.58MHz$		0.01		%
Differential Phase (Note 2)	DP	$f = 3.58MHz$		0.01		degrees
All-Hostile Crosstalk		$V_{IN} = 1Vp-p$ , $f = 30MHz$	MAX4121		-92	dB
			MAX4221		-70	
Off Isolation		$V_{IN} = 1Vp-p$ , $f = 30MHz$ , see test circuit	MAX4111		86	dB
			MAX4121		78	
			MAX4221		84	
Channel Switching Off Time	$t_{OFF}$			1.0		$\mu s$
Channel Switching On Time	$t_{ON}$			500		ns
Switching Transient				13		mVp-p
Group Delay				860		ps
Input-Output Delay Matching		Chip-to-chip, $f = 3.58MHz$		$\pm 0.2$		degrees
Second Harmonic		$f = 30MHz$ , $V_{IN} = 1.4Vp-p$		-65		dBc
Third Harmonic		$f = 30MHz$ , $V_{IN} = 1.4Vp-p$		-70		dBc

**Note 1:** Full-Power Bandwidth is inferred from Slew Rate (SR) testing by the equation  $SR = \omega E_p$ , where  $E_p$  is the peak output voltage and  $\omega = 2\pi f$ .

**Note 2:** Differential Gain and Phase are tested using a modulated ramp, 100IRE (0.714V).

**8**

# 330MHz Buffered Video Switches/ Crosspoint Building Blocks

## Typical Operating Characteristics

( $V_S = \pm 5V$ ,  $R_L = 5k\Omega$ ,  $C_L \leq 5pF$ ,  $T_A = +25^\circ C$ , unless otherwise noted.)

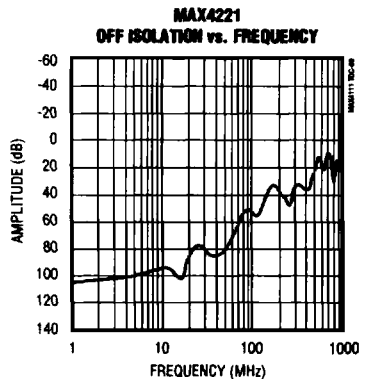
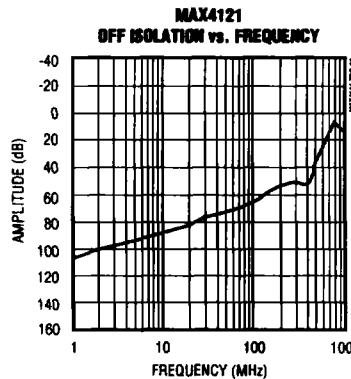
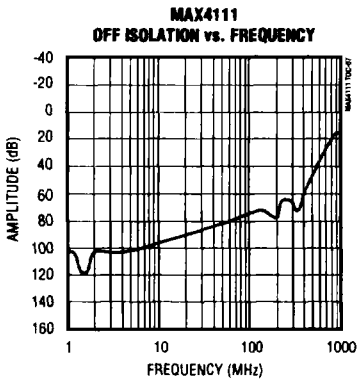
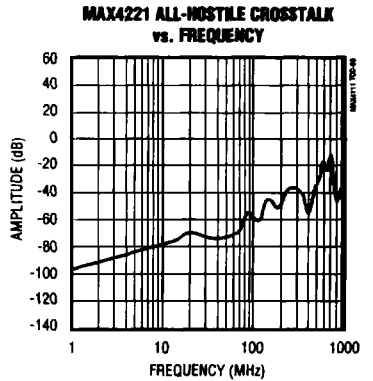
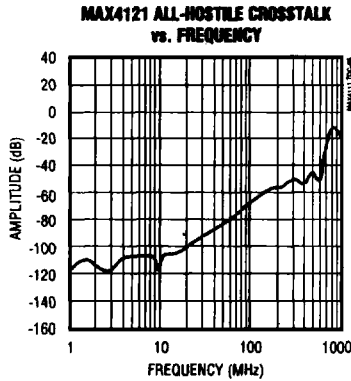
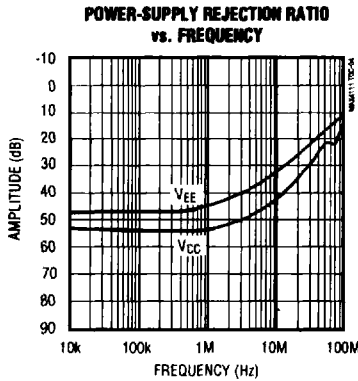
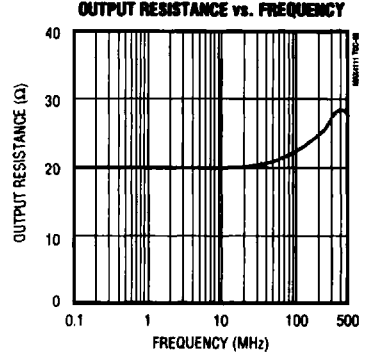
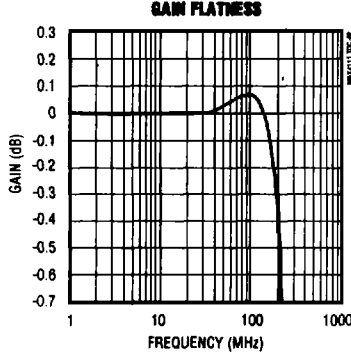
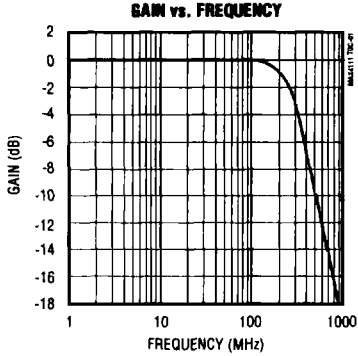

# 330MHz Buffered Video Switches/ Crosspoint Building Blocks

## Typical Operating Characteristics (continued)

( $V_S = \pm 5V$ ,  $R_L = 5k\Omega$ ,  $C_L \leq 5pF$ ,  $T_A = +25^\circ C$ , unless otherwise noted.)

**SMALL-SIGNAL PULSE RESPONSE**  
( $R_L = 5k\Omega$ )

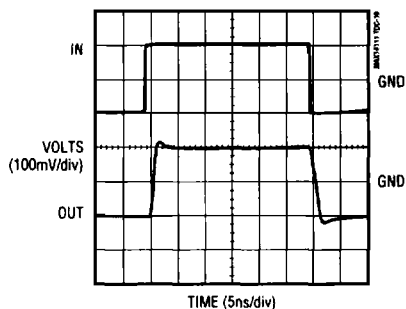

**LARGE-SIGNAL PULSE RESPONSE**  
( $R_L = 5k\Omega$ )

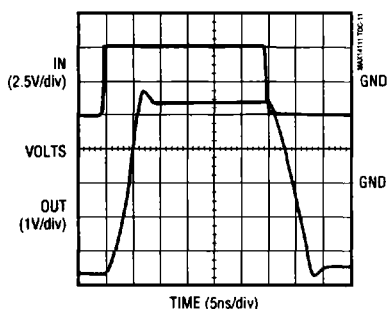

**SMALL-SIGNAL PULSE RESPONSE**  
( $C_L = 47pF$ ,  $R_L = \text{open}$ )

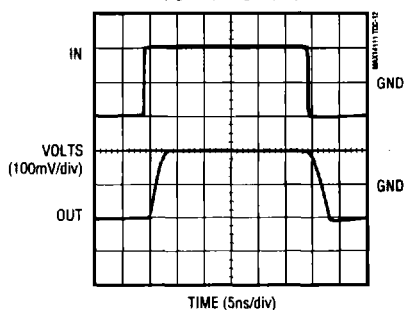

**LARGE-SIGNAL PULSE RESPONSE**  
( $C_L = 47pF$ ,  $R_L = \text{open}$ )

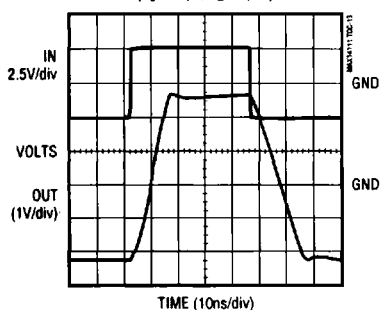

**ENABLE/DISABLE DELAY TIME**  
(INPUT = 1.1V)

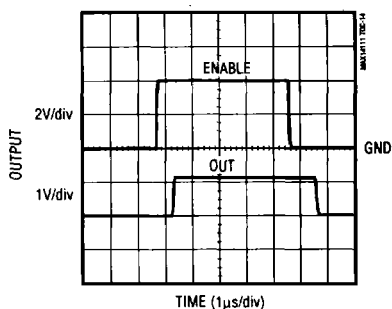

**OUTPUT GLITCH AMPLITUDE**

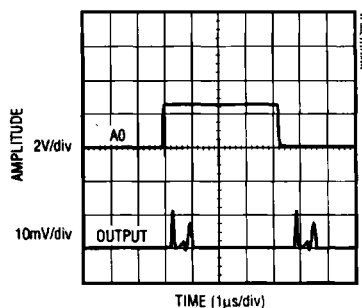

# 330MHz Buffered Video Switches/ Crosspoint Building Blocks

## Typical Operating Characteristics (continued)

( $V_S = \pm 5V$ ,  $R_L = 5k\Omega$ ,  $C_L \leq 5pF$ ,  $T_A = +25^\circ C$ , unless otherwise noted.)

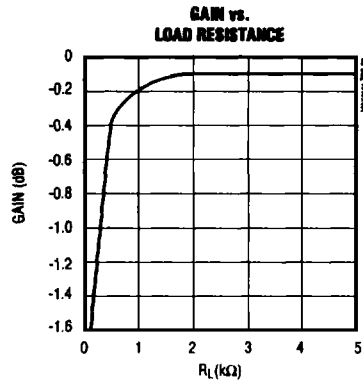
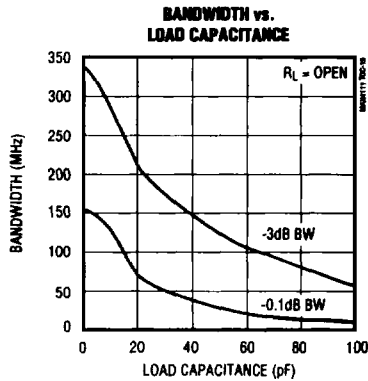
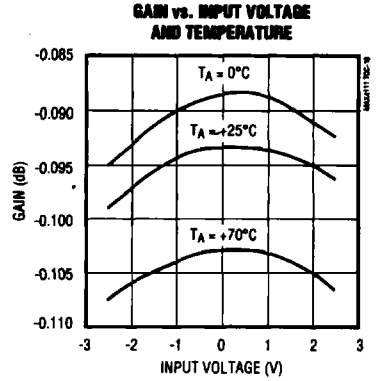
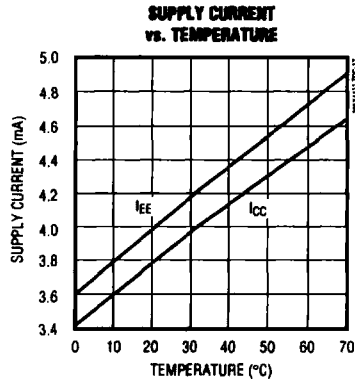
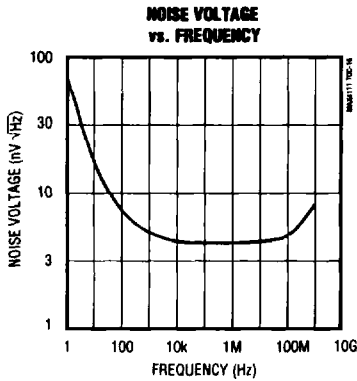

# 330MHz Buffered Video Switches/ Crosspoint Building Blocks

## Pin Description

MAX4111/MAX4121/MAX4221

PIN			NAME	FUNCTION
MAX4111	MAX4121	MAX4221		
1, 3	3	2, 4, 5, 7	GND	Analog (signal) ground. Since inputs are isolated by these grounds, GND should be as noise-free as possible.
—	1	—	A0	Logic Input. Channel Selection Bit for the 2x1. See Table 2.
2	—	—	IN	Signal Input
—	2, 4	1, 3	IN0, IN1	Signal Input
4	—	—	N.C.	No Connect—not internally connected
5	5	12	VEE	Negative Power-Supply Voltage. Connect to -5V. Decouple to power ground.
6	6	—	OUT	Signal Output
—	—	6, 8	IN2, IN3	Signal Inputs for the dual 2x1 switch
7	7	14	VCC	Positive Power-Supply Voltage. Connect to +5V. Decouple to power ground.
8	8	—	EN	Logic Input. Output Enable for the 1x1, 2x1 switches. A logic high on this pin enables the output. A logic low causes the output to assume a high-impedance state, and reduces supply current.
—	—	9, 10	SEL3, SEL2	Logic Inputs. Channel Selection Bits for OUT1 of the dual 2x1 (MAX4221). See Table 3.
—	—	11, 13	OUT1, OUT0	Signal Outputs
—	—	15, 16	SEL1, SEL0	Logic Inputs. Channel Selection Bits for OUT0 of the dual 2x1 (MAX4221). See Table 3.

### Detailed Description

The MAX4111/MAX4121/MAX4221 video switches are manufactured with Maxim's proprietary, ultra-high frequency, complementary bipolar process that yields high bandwidth and low capacitance. Make-before-break switching is used to reduce noise and glitches, even when switching from part to part in large arrays. The input buffers provide a constant high input impedance, and prevent the make-before-break action from feeding back to the input.

The design of the switching mechanism limits the inevitable glitch to less than 13mVp-p. In addition, the glitch pulse is positive to avoid confusion with negative sync pulses.

Unity-gain buffers isolate other inputs from the switching action of large multiplex arrays. These buffers can drive 5k $\Omega$  resistive loads. In addition, these devices drive capacitive loads without oscillation. Load capacitance is limited only by system bandwidth requirements.

The MAX4111/MAX4121/MAX4221 do not contain buffer latches. The digital inputs are transparent.

8

## 330MHz Buffered Video Switches/ Crosspoint Building Blocks

**Table 1. MAX4111 Truth Table**

EN	OUT
0	High-Z
1	IN

**Table 2. MAX4121 Truth Table**

A0	EN	OUT
X	0	High-Z
0	1	IN0
1	1	IN1

**Table 3. MAX4221 Truth Table**

SEL0	SEL1	OUT0
0	0	High-Z
1	0	IN0
0	1	IN1
1	1	NA

SEL2	SEL3	OUT1
0	0	High-Z
1	0	IN2
0	1	IN3
1	1	NA

Note: SEL0 = SEL1 = 1 and/or SEL2 = SEL3 = 1 is not allowed. Enabling these states will not damage the device, but may cause excessive supply currents and distortion.

### Applications Information

#### Grounding, Bypassing, and PC Board Layout

To obtain the full 330MHz bandwidth of these switches, Microstrip and Stripline techniques are recommended. To ensure your PC board does not degrade the switch's performance, it's wise to design the board for a frequency greater than 1GHz. Even with very short runs, it's good practice to use this technique at critical points such as inputs and outputs.

Use the following guidelines when designing the board:

- Do not use wire-wrap boards, because they are too inductive.
- Do not use IC sockets. They increase parasitic capacitance and inductance.

- In general, surface-mount components have shorter leads and lower parasitic reactance, and give better high-frequency performance than through-hole components.
- The PC board should have at least two layers, with one side a signal side and the other a ground plane.
- Keep signal lines as short and straight as possible. Do not make 90° turns; round all corners.
- The ground plane should be as free from voids as possible.

#### Bypass Components—Capacitors

Surface-mount ceramic capacitors are recommended to achieve good high-frequency bypassing. A 0.1µF capacitor in parallel with a 1000pF capacitor should be used for each supply. The capacitors should be located as close to the ICs supply pins as possible, with the smaller value capacitor being closer to the IC than the other.

#### Creating Larger Arrays

The MAX4111/MAX4121/MAX4221 were designed as building blocks for larger arrays. The single-pole switch allows the system designer much greater control over crosstalk than multiple switches in a single IC. For this reason, cable drivers have not been included in the switch design because of the high-power drive required (see Figure 6).

Even though the stability of these devices is not worsened by adding capacitance, you may want to limit the number of switches connected together. The MAX4111/MAX4121/MAX4221 have a finite input capacitance of about 3pF and a dynamic output resistance of about 20Ω. This causes a pole at a little more than 2.7GHz. However, in a large array with many switch inputs, the total capacitance is N x 3pF, where "N" is the number of switches connected in parallel. The pole will be located at:

$$\frac{1}{2\pi \times (N \times 3\text{pF} + C_{\text{STRAY}}) \times 20\Omega} \text{ MHz}$$

C<sub>STRAY</sub> = Stray capacitance at the interconnect

If the maximum number of switches that may be connected while still maintaining bandwidth is less than your system requirements, use a unity-gain buffer amplifier to isolate the switch from the remainder of the inputs.



# 330MHz Buffered Video Switches/ Crosspoint Building Blocks

## Test Circuits

MAX4111/MAX4121/MAX4221

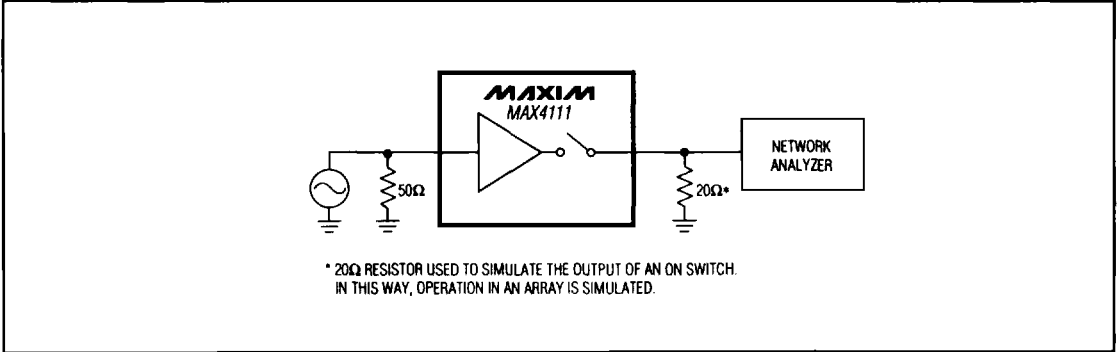

Figure 1. MAX4111 Off Isolation

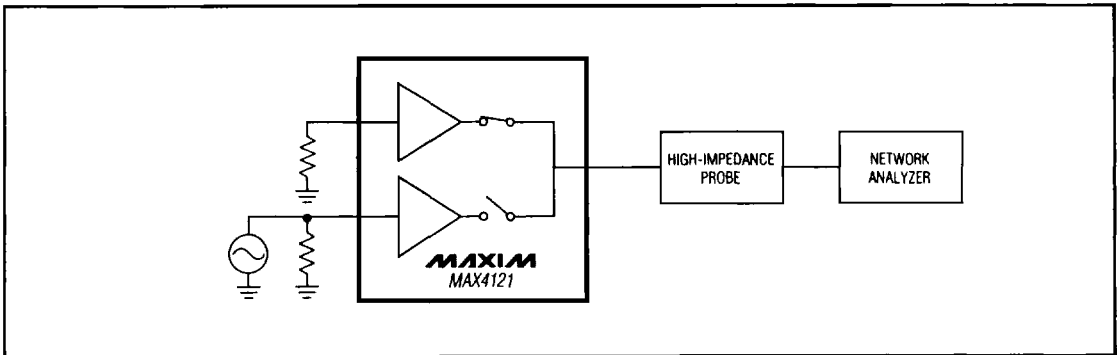

Figure 2. MAX4121 All-Hostile Crosstalk

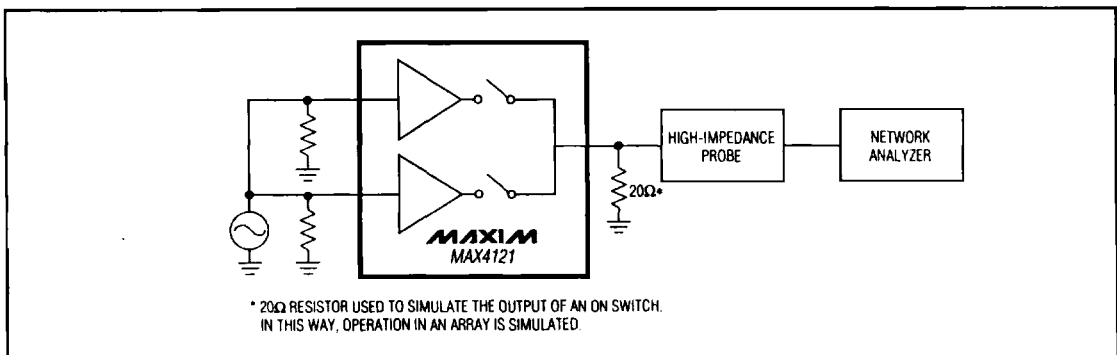

Figure 3. MAX4121 Off Isolation

# 330MHz Buffered Video Switches/ Crosspoint Building Blocks

**MAX4111/MAX4121/MAX4221**

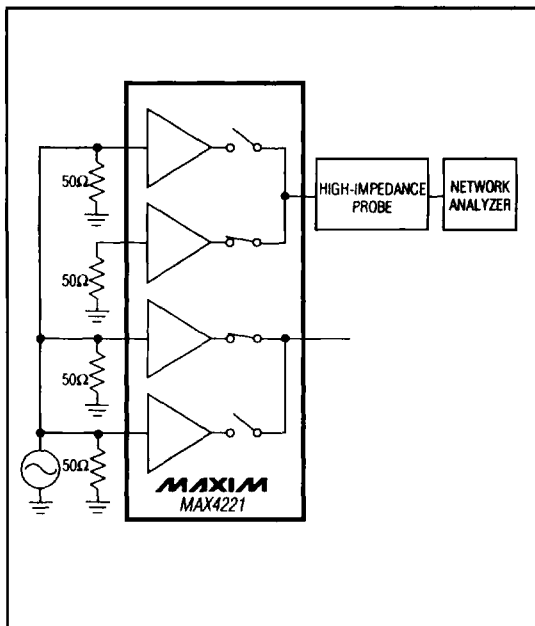

Figure 4. MAX4221 All-Hostile Crosstalk

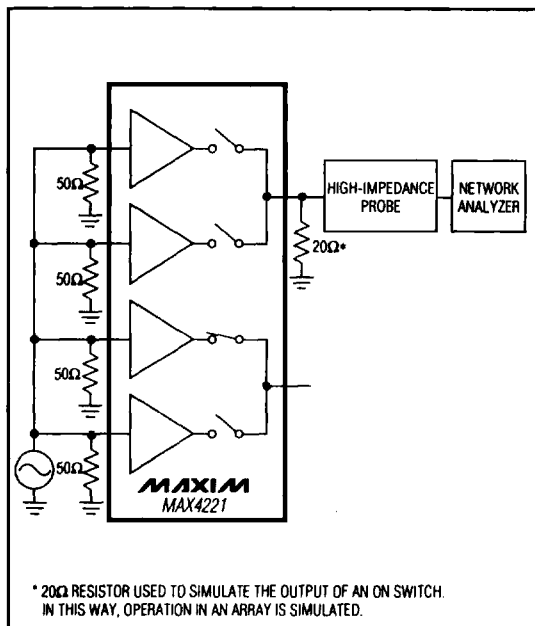

Figure 5. MAX4221 Off Isolation

# 330MHz Buffered Video Switches/ Crosspoint Building Blocks

MAX4111/MAX4121/MAX4221

8

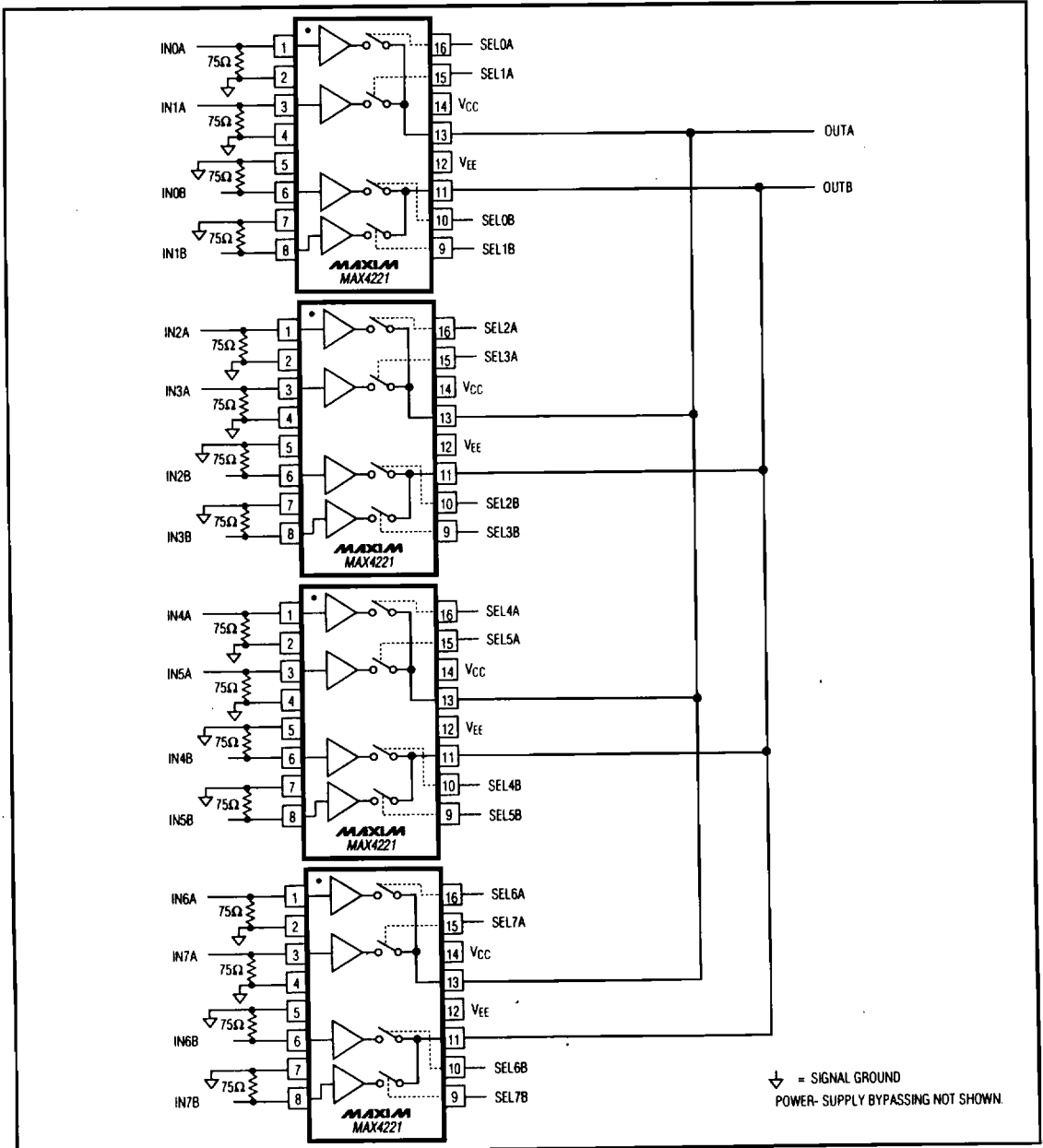

Figure 6. 8x2 Multiplexer Using MAX4221