



AT-60500
Up to 6 GHz Low Noise
Silicon Bipolar Transistor
Chip

T-31-19

Features

- Low Bias Current Operation
- Low Noise Figure: 1.8 dB typical at 2.0 GHz
2.8 dB typical at 4.0 GHz
- High Associated Gain: 12.5 dB typical at 2.0 GHz
8.0 dB typical at 4.0 GHz
- High Gain-Bandwidth Product: 9.0 GHz typical fr

Description

Avantek's AT-60500 is a high performance NPN silicon bipolar transistor chip designed for use low noise, wide band amplifier and oscillator applications operating over VHF, UHF and micro-wave frequencies.

The die are nitride-passivated for surface protection. Excellent device uniformity, performance and reliability are produced by the use of ion-implantation, self-alignment techniques, and gold metallization in the fabrication of these devices.

The recommended assembly procedure is gold-eutectic die attach at 400°C and either wedge or ball bonding using 0.7 mil gold wire. See also "Chip Use" in the APPLICATIONS section.

Avantek Chip Outline¹

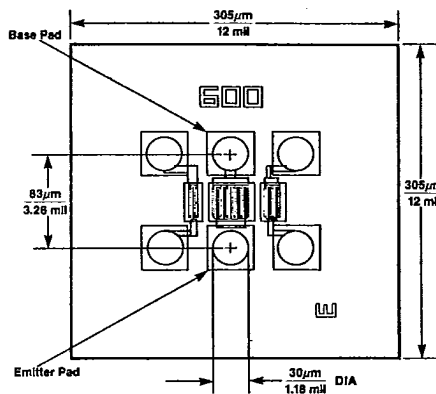

NOISE FIGURE AND ASSOCIATED GAIN vs. FREQUENCY
 $V_{CE} = 8\text{ V}, I_C = 2\text{ mA}$

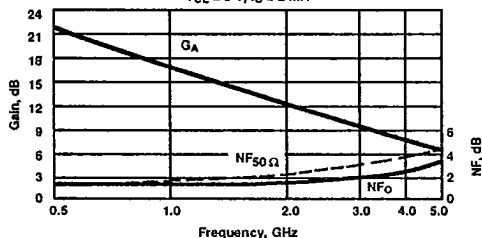

Noise Parameters: $V_{CE} = 8\text{ V}, I_C = 2\text{ mA}$

Freq. GHz	NF ₀ dB	Gamma Opt Mag	Ang	R _N /50
1.0	1.4	.58	44	0.20
2.0	1.8	.48	90	0.24
4.0	2.8	.50	155	0.20

Electrical Specifications, T_A = 25°C

Symbol	Parameters and Test Conditions ^{1,2}	Units	Min.	Typ.	Max.
NF ₀	Optimum Noise Figure: $V_{CE} = 8\text{ V}, I_C = 2\text{ mA}$ $f = 1.0\text{ GHz}$ $f = 2.0\text{ GHz}$ $f = 4.0\text{ GHz}$	dB		1.4 1.8 2.8	
GA	Gain @ NF ₀ : $V_{CE} = 8\text{ V}, I_C = 2\text{ mA}$ $f = 1.0\text{ GHz}$ $f = 2.0\text{ GHz}$ $f = 4.0\text{ GHz}$	dB		16.5 12.5 8.0	
S ₂₁ E ²	Insertion Power Gain: $V_{CE} = 8\text{ V}, I_C = 10\text{ mA}$ $f = 2.0\text{ GHz}$ $f = 4.0\text{ GHz}$	dB		12.0 6.5	
P ₁ dB	Power Output @ 1 dB Gain Compression: $V_{CE} = 8\text{ V}, I_C = 10\text{ mA}$ 1 dB Compressed Gain: $V_{CE} = 8\text{ V}, I_C = 10\text{ mA}$ $f = 2.0\text{ GHz}$	dBm		16.0	
f _T	Gain Bandwidth Product: $V_{CE} = 8\text{ V}, I_C = 10\text{ mA}$	GHz		9.0	
h _{FE}	Forward Current Transfer Ratio: $V_{CE} = 8\text{ V}, I_C = 10\text{ mA}$		30	150	300
I _{CB0}	Collector Cutoff Current: $V_{CB} = 8\text{ V}$	µA			0.2
I _{EBO}	Emitter Cutoff Current: $V_{EB} = 1\text{ V}$	µA			1.0
CCB	Collector Base Capacitance ³ : $V_{CB} = 8\text{ V}, f = 1\text{ MHz}$	pF		0.11	

Notes: 1. This chip contains 3 active devices. The performance specified applies only to the device whose base and emitter pads are indicated on the chip outline.
 2. RF performance is determined by packaging and testing 10 devices per wafer.
 3. For this test, the emitter is grounded.

AT-60500
Low Noise Silicon Bipolar Transistor

T-31-19

Absolute Maximum Ratings

Parameter	Symbol	Absolute Maximum
Emitter-Base Voltage	VEBO	1.5 V
Collector-Base Voltage	VCBO	20 V
Collector-Emitter Voltage	VCEO	12 V
Collector Current	IC	40 mA
Power Dissipation ^{2,3}	PT	400 mW
Junction Temperature	Tj	200°C
Storage Temperature	TSTG	-65°C to 200°C

Thermal Resistance^{2,4}: $\theta_{jc} = 120^\circ\text{C/W}$

Notes:

1. Operation of this device above any one of these parameters may cause permanent damage.
2. T_{MOUNTING SURFACE} = 25°C.
3. Derate at 8.3 mW/°C for T_{MOUNTING SURFACE} > 152°C.
4. The small spot size of this technique results in a higher, though more accurate determination of θ_{jc} than do alternate methods. See MEASUREMENTS section "Thermal Resistance" for more information.

Part Number Ordering Information

Part Number	Devices Per Tray
AT-60500-GP2	10
AT-60600-GP4	100
AT-60500-GP6	up to 300

Typical Performance, T_A = 25°C
 (unless otherwise noted)

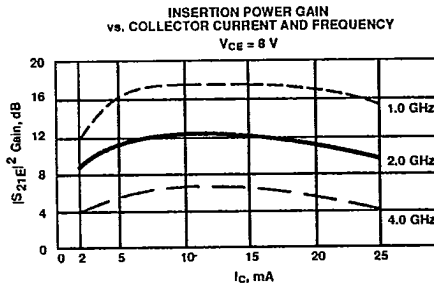
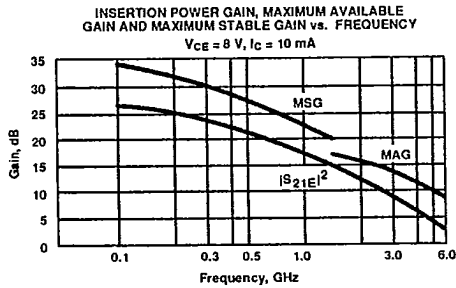
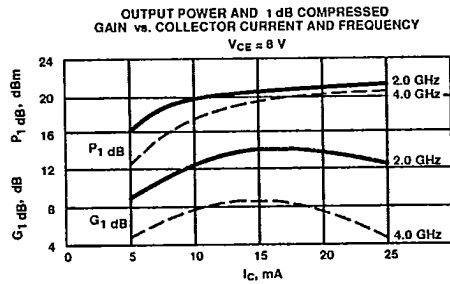
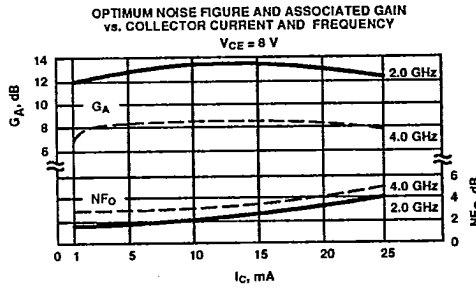
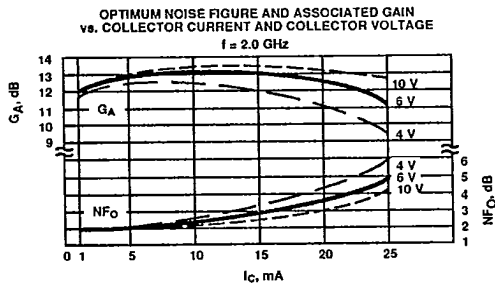

T-31-19

AT-60500
Low Noise Silicon Bipolar Transistor

Typical Scattering Parameters: Common Emitter, $Z_0 = 50 \Omega$

$T_A = 25^\circ\text{C}$, $V_{CE} = 8 \text{ V}$, $I_C = 2 \text{ mA}$

Freq. GHz	S ₁₁		S ₂₁			S ₁₂			S ₂₂	
	Mag	Ang	dB	Mag	Ang	dB	Mag	Ang	Mag	Ang
0.1	.97	-6	16.7	6.86	176	-40.0	.010	85	.92	-7
0.5	.88	-34	14.3	5.17	149	-27.3	.043	71	.95	-13
1.0	.74	-72	12.0	4.00	127	-23.3	.068	55	.84	-16
1.5	.60	-101	10.2	3.22	112	-22.6	.074	48	.76	-19
2.0	.57	-123	9.0	2.83	97	-21.6	.083	43	.71	-22
2.5	.53	-140	7.7	2.43	88	-21.4	.085	45	.69	-23
3.0	.49	-158	6.5	2.11	79	-21.4	.085	50	.67	-24
3.5	.50	-167	5.3	1.85	73	-21.0	.089	51	.66	-26
4.0	.50	-176	4.2	1.63	68	-20.6	.093	56	.66	-28
4.5	.50	174	3.1	1.43	61	-20.5	.095	58	.67	-30
5.0	.50	166	2.3	1.30	56	-20.0	.100	64	.68	-32
5.5	.52	158	1.7	1.22	50	-19.4	.107	67	.67	-36
6.0	.50	148	0.8	1.10	45	-18.9	.114	70	.69	-39

$T_A = 25^\circ\text{C}$, $V_{CE} = 8 \text{ V}$, $I_C = 10 \text{ mA}$

0.1	.68	-21	26.9	22.02	166	-40.9	.009	80	.95	-7
0.5	.55	-93	22.5	13.27	123	-31.7	.026	60	.74	-20
1.0	.46	-137	17.8	7.73	101	-28.9	.036	58	.63	-17
1.5	.44	-160	14.7	5.41	90	-27.1	.044	65	.58	-16
2.0	.44	-173	12.2	4.05	82	-25.5	.053	68	.57	-17
2.5	.45	178	10.5	3.36	77	-23.9	.064	72	.57	-18
3.0	.45	169	9.1	2.84	71	-22.5	.075	76	.56	-20
3.5	.46	163	7.8	2.45	66	-21.4	.085	78	.56	-22
4.0	.46	157	6.7	2.16	63	-20.4	.096	81	.57	-24
4.5	.47	150	5.5	1.88	56	-19.5	.106	80	.58	-27
5.0	.47	144	4.7	1.72	53	-18.6	.117	83	.59	-28
5.5	.50	140	4.0	1.58	48	-17.8	.129	83	.59	-32
6.0	.49	132	3.1	1.43	43	-17.1	.139	82	.61	-36

A model for this device is available in the DEVICE MODELS section.