

Flyback Transformer P/N T-905

4 WATTS

Parameter	Min.	Typ.	Max.	Units
Inductance (1-2)	11.2			mH
¹ Leakage Inductance			50	μH
² Interwinding Capacitance			25	pF
DC Resistance (1-2)		4.3		Ω
	(3-4)	0.34		Ω
	(5-6)	0.50		Ω
	(7-8)	0.03		Ω
	(9-10)	0.02		Ω
Hi-Pot Pins (1-2) to (4-3) + (5-6) (7-8) + (9+10)	3000			V _{RMS}
Operating Frequency		100		kHz

¹Connected 1-2, shorted 3,4,5,6,7,8,9,10 (10KHz - 100mV)

²Connected 1-10, shorted 4-5, 6-7, 8-9 (10KHz - 100mV)

Schematic Diagram

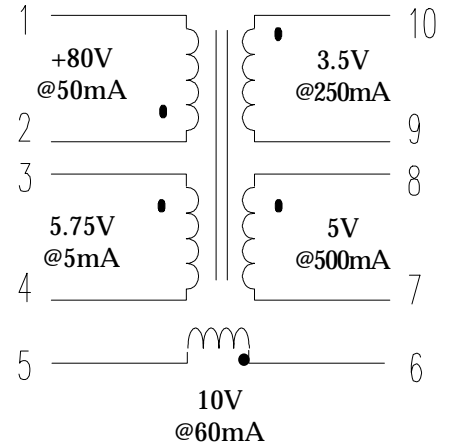

Physical Dimensions inches (mm)

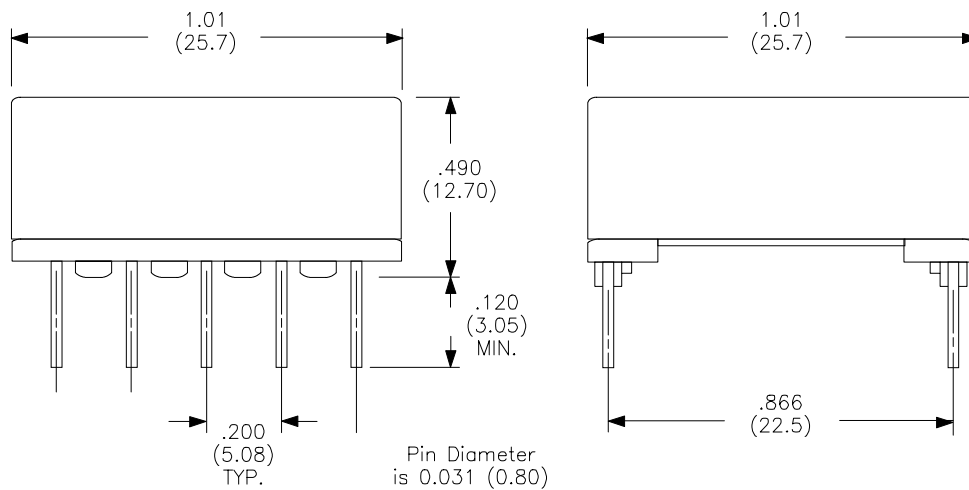

3/18/97