

## CDSV4148-G

RoHS Device

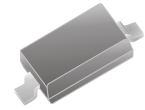

### Features

- Fast Switching Speed
- High Conductance
- Surface Mount Package Ideally Suited for Automatic Insertion
- For General Purpose Switching Applications.

### Mechanical data

- Case: SOD-323, Molded Plastic
- Terminals: Solderable per MIL-STD-202, Method 208
- Mounting position: Any.

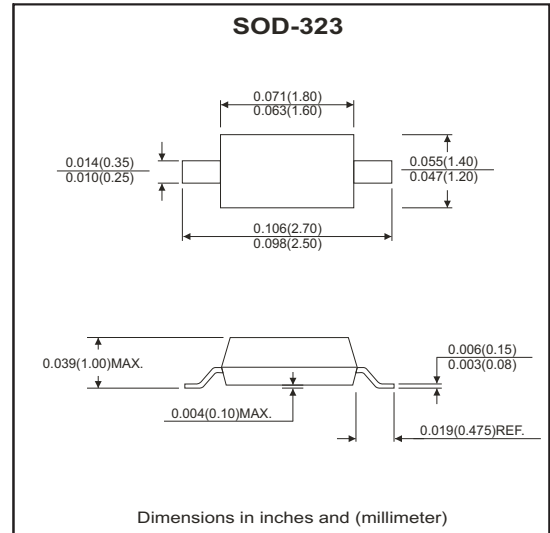

### Maximum Ratings (at TA=25°C unless otherwise noted)

Parameter	Conditions	Symbol	Min	Max	Unit
Non-Repetitive peak reverse voltage		V <sub>RM</sub>		100	V
Peak repetitive peak reverse voltage		V <sub>RRM</sub>		75	V
Working peak reverse voltage		V <sub>RWM</sub>		75	V
DC blocking voltage		V <sub>R</sub>		75	V
RMS reverse voltage		V <sub>R(RMS)</sub>		53	mV
Forward continuous current		I <sub>FM</sub>		300	mA
Average rectified output current		I <sub>o</sub>		150	mA
Peak forward surge current	T <sub>P</sub> = 1μS T <sub>P</sub> = 1S	I <sub>FSM</sub>		2 1	A
Power dissipation		P <sub>D</sub>		200	mW
Thermal Resistance (Junction to ambient)		R <sub>θJA</sub>		625	°C/W
Storage temperature		T <sub>STG</sub>	-65	+150	°C
Junction temperature		T <sub>j</sub>		+125	°C

### Electrical Characteristics (at TA=25°C unless otherwise noted)

Parameter	Conditions	Symbol	Min	Typ	Max	Unit
Forward voltage	I <sub>F</sub> = 1mA DC I <sub>F</sub> = 10mA DC I <sub>F</sub> = 50mA DC I <sub>F</sub> = 150mA DC	V <sub>F</sub>			0.715 0.855 1.0 1.25	V
Reverse current	V <sub>R</sub> = 20 V V <sub>R</sub> = 75 V	I <sub>R</sub>			25 1	nA μA
Capacitance between terminals	f = 1 MHz, and 0VDC reverse voltage	C <sub>T</sub>			2	pF
Reverse recovery time	I <sub>F</sub> = I <sub>R</sub> 10 mA, R <sub>L</sub> = 100 ohms, I <sub>rr</sub> = 0.1 X I <sub>R</sub>	T <sub>RR</sub>			4	nS

## PATING AND CHARACTERISTIC CURVES (CDSV4148-G)

Fig.1 - Forward Characteristics

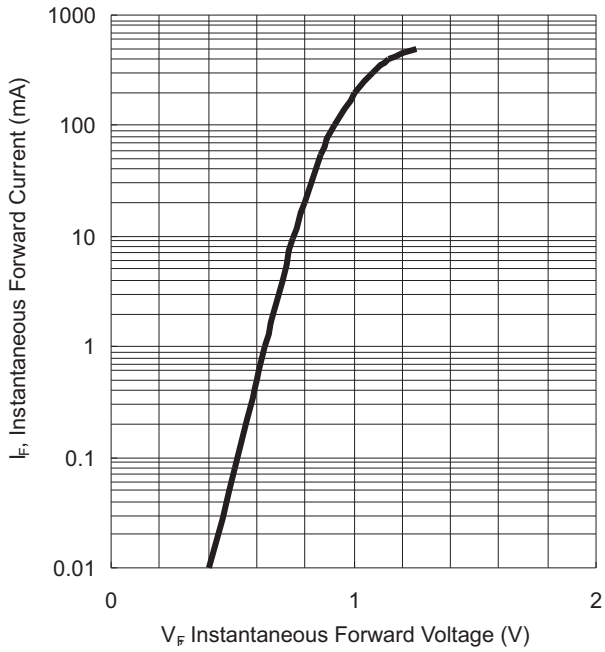
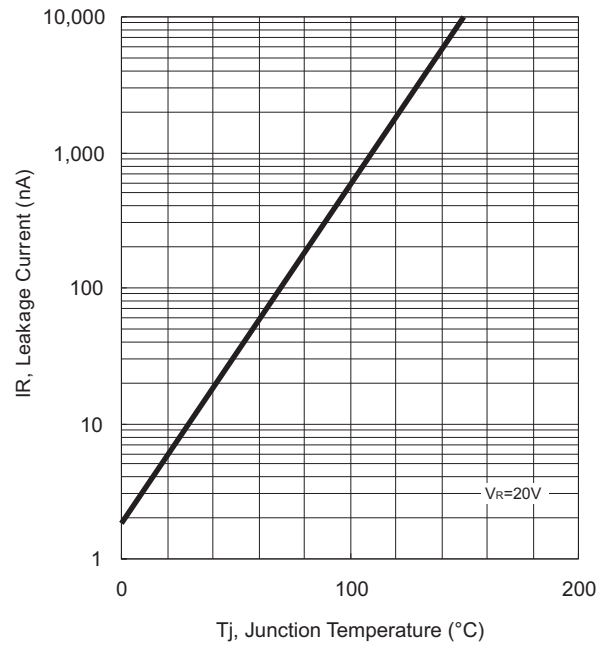
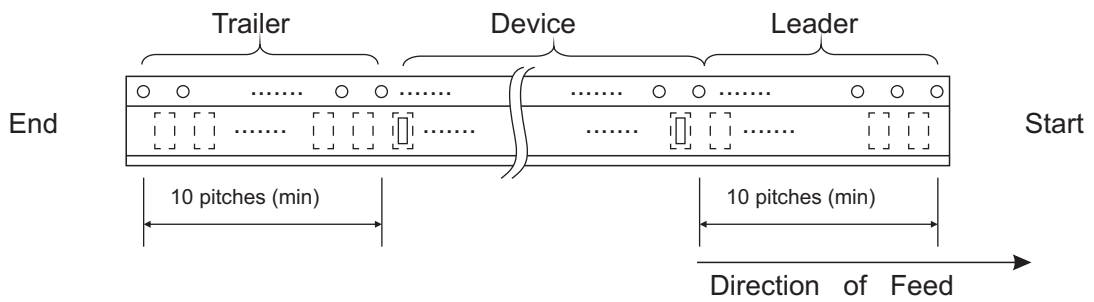
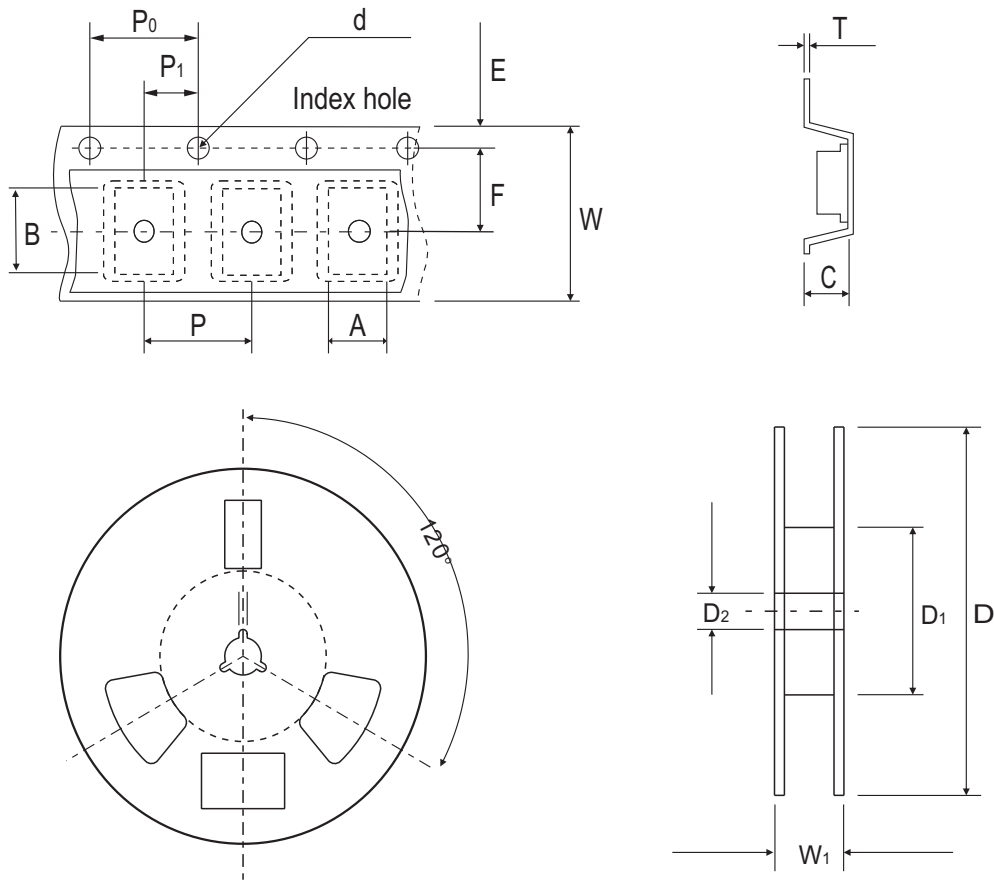

Fig.2 - Leakage current V.S. Junction Temperature



## Reel Taping Specification



SOD-323	SYMBOL	A	B	C	d	D	D1	D2
	(mm)	1.52 ± 0.10	2.90 ± 0.10	1.35 ± 0.10	1.50 ± 0.10	178 ± 1	54.4 MIN.	13.0 ± 0.20
	(inch)	0.060 ± 0.004	0.114 ± 0.004	0.053 ± 0.004	0.059 ± 0.004	7.008 ± 0.040	2.142 MIN.	0.512 ± 0.008

SOD-323	SYMBOL	E	F	P	P0	P1	W	W1
	(mm)	1.75 ± 0.10	3.50 ± 0.05	4.00 ± 0.10	4.00 ± 0.10	2.00 ± 0.05	8.00 ± 0.30	9.5 MAX.
	(inch)	0.069 ± 0.004	0.138 ± 0.002	0.157 ± 0.004	0.157 ± 0.004	0.079 ± 0.002	0.315 ± 0.012	0.374 MAX.

## Marking Code

Part Number	Marking Code
CDSV4148-G	T4



## Suggested PAD Layout

SIZE	SOD-323	
	(mm)	(inch)
A	2.33	0.092
B	0.70	0.028
C	0.70	0.028
D	3.03	0.119
E	1.63	0.064

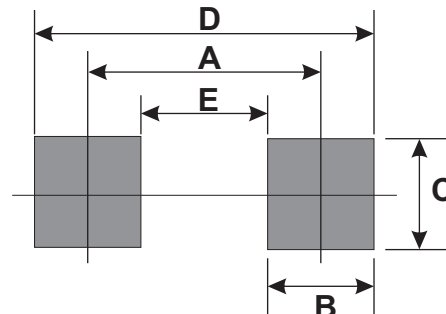

## Standard Packaging

Case Type	REEL PACK	
	REEL ( pcs )	Reel Size (inch)
SOD-323	3,000	7