

ADVANCED POWER TECHNOLOGY T-39-13

APT4055AN 400V 10.5A 0.55 Ω
APT3555AN 350V 10.5A 0.55 Ω

POWER MOS IV™

N - CHANNEL ENHANCEMENT MODE HIGH VOLTAGE POWER MOSFETS

MAXIMUM RATINGS

All Ratings: $T_C = 25^\circ\text{C}$ unless otherwise specified.

Symbol	Parameter	APT3555AN	APT4055AN	UNIT
V_{DSS}	Drain-Source Voltage	350	400	Volts
I_D	Continuous Drain Current	10.5		Amps
I_{DM}	Pulsed Drain Current ¹	42		Amps
V_{GS}	Gate-Source Voltage	±30		Volts
P_D	Total Power Dissipation @ $T_C = 25^\circ\text{C}$, Derate Above 25°C	150		Watts
T_J, T_{STG}	Operating and Storage Junction Temperature Range	- 55 to 150		$^\circ\text{C}$

STATIC ELECTRICAL CHARACTERISTICS

Symbol	Characteristic / Test Conditions	MIN	TYP	MAX	UNIT
BV_{DSS}	Drain-Source Breakdown Voltage ($V_{GS} = 0V, I_D = 250 \mu\text{A}$)	APT4055AN	400		Volts
		APT3555AN	350		Volts
I_{DSS}	Zero Gate Voltage Drain Current ($V_{DS} = V_{DSS}, V_{GS} = 0V$)			250	μA
	($V_{DS} = 0.8 V_{DSS}, V_{GS} = 0V, T_C = 125^\circ\text{C}$)			1000	
I_{GSS}	Gate-Source Leakage Current ($V_{GS} = \pm 30V, V_{DS} = 0$)			±100	nA
$I_{D(ON)}$	On State Drain Current ² ($V_{DS} > I_{D(ON)} \times R_{DS(ON)} \text{ Max}, V_{GS} = 10V$)	10.5			Amps
$V_{GS(TH)}$	Gate Threshold Voltage ($V_{DS} = V_{GS}, I_D = 1\text{mA}$)	2		4	Volts
$R_{DS(ON)}$	Static Drain-Source On-State Resistance ² ($V_{GS} = 10V, I_D = 0.5 I_D \text{ (Cont.)}$)			0.55	Ohms

THERMAL CHARACTERISTICS

Symbol	Characteristic	MIN	TYP	MAX	UNIT
$R_{\theta JC}$	Junction to Case			0.85	$^\circ\text{C/W}$
$R_{\theta JA}$	Junction to Ambient			30	$^\circ\text{C/W}$
T_L	Max. Lead Temp. for Soldering Conditions: 0.063" from Case for 10 Sec.			300	$^\circ\text{C}$

405 S.W. COLUMBIA STREET
 BEND, OREGON 97702
 U.S.A.

PHONE . . . (503) 382 - 8028
 (800) 222 - 8APT
 FAX (503) 388 - 0364

DYNAMIC CHARACTERISTICS

APT4055/3555AN

T-39-13

Symbol	Characteristic	Test Conditions	MIN	TYP	MAX	UNIT
C_{iss}	Input Capacitance	$V_{GS} = 0V$ $V_{DS} = 25V$ $f = 1\text{ MHz}$	650		850	pF
C_{oss}	Output Capacitance		125		275	pF
C_{riss}	Reverse Transfer Capacitance		65		130	pF
Q_g	Total Gate Charge ³	$V_{GS} = 10V, I_D = I_D(\text{Cont.})$ $V_{DD} = 0.5 V_{DSS}$	27		47	nC
Q_{gs}	Gate-Source Charge		3.5		7.5	nC
Q_{gd}	Gate-Drain ("Miller") Charge		14		22	nC
$t_d(\text{on})$	Turn-on Delay Time	$V_{DD} = 0.5 V_{DSS}$ $I_D = I_D(\text{Cont.}), V_{GS} = 15V$ $R_G = 1.8\Omega$			15	ns
t_r	Rise Time				20	ns
$t_d(\text{off})$	Turn-off Delay Time				45	ns
t_f	Fall Time				25	ns

SOURCE-DRAIN DIODE RATINGS AND CHARACTERISTICS

Symbol	Characteristic / Test Conditions	MIN	TYP	MAX	UNIT
I_S	Continuous Source Current (Body Diode)			10.5	Amps
I_{SM}	Pulsed Source Current ¹ (Body Diode)			42	Amps
V_{SD}	Diode Forward Voltage ² ($V_{GS} = 0V, I_S = -I_D(\text{Cont.})$)			1.3	Volts
t_{rr}	Reverse Recovery Time $I_S = -I_D(\text{Cont.})$ $di_S/dt = 100A/\mu s$	180	220	260	ns
Q_{rr}	Reverse Recovery Charge	2.4	3.1	3.8	μC

SAFE OPERATING AREA CHARACTERISTICS

Symbol	Characteristic	Test Conditions	MIN	TYP	MAX	UNIT
SOA1	Safe Operating Area	$V_{DS} = 0.4 V_{DSS}, I_{DS} = P_D / 0.4 V_{DSS}, t = 1\text{ Sec.}$	150			Watts
SOA2	Safe Operating Area	$I_{DS} = I_D(\text{Cont.}), V_{DS} = P_D / I_D(\text{Cont.}), t = 1\text{ Sec.}$	150			Watts
I_{LM}	Inductive Current Clamped		42			Amps

1.) Repetitive Rating: Pulse width limited by maximum junction temperature. See Transient Thermal Impedance Curve. (Fig.1)

2.) Pulse Test: Pulse width < 380 μs
Duty Cycle < 2%
3.) See JEDEC MIL-STD-750C Method 3471

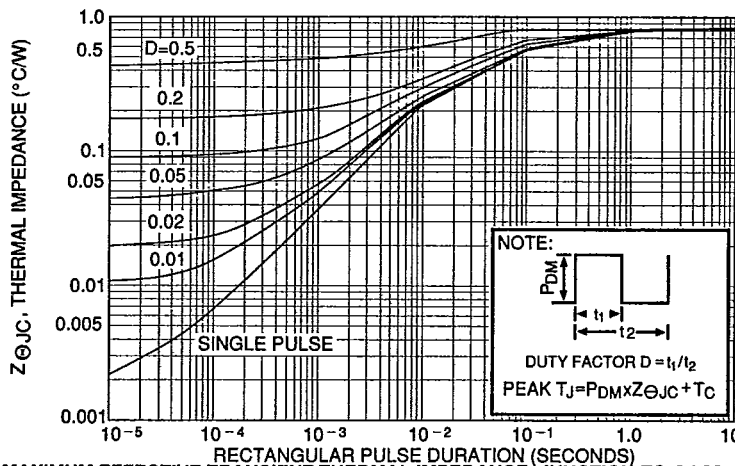
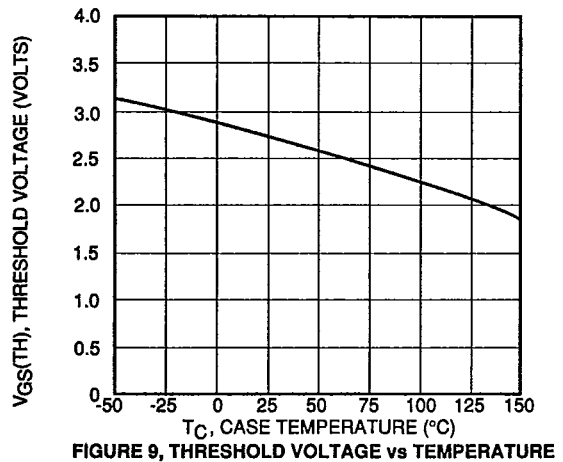
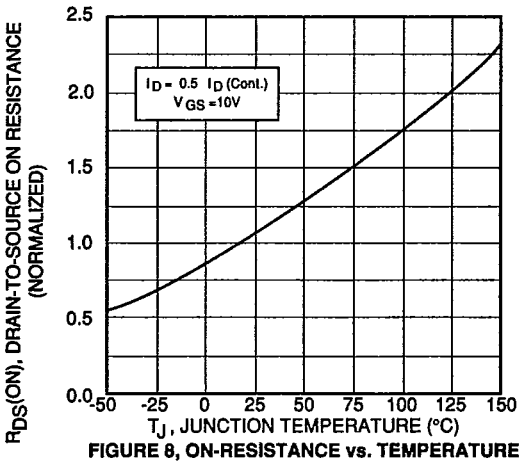
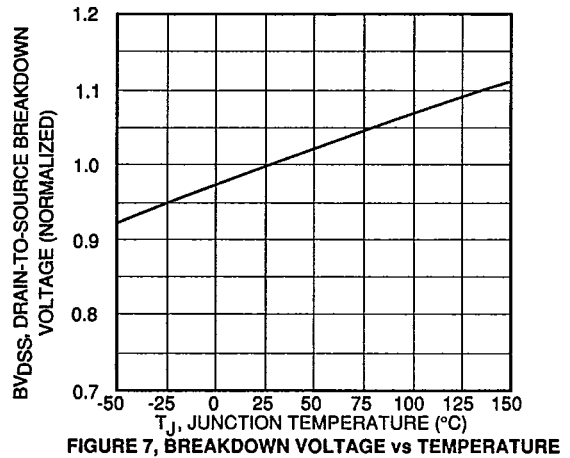
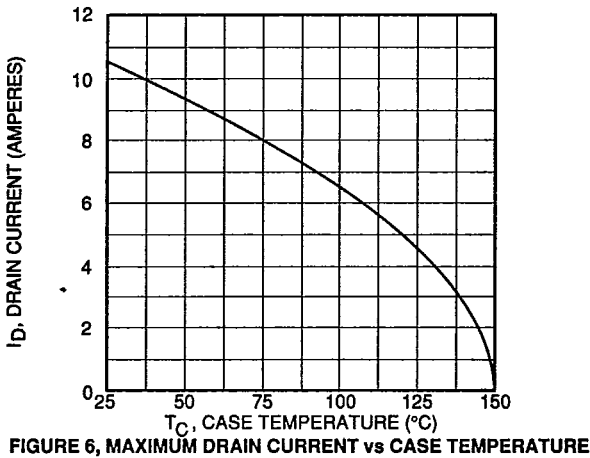
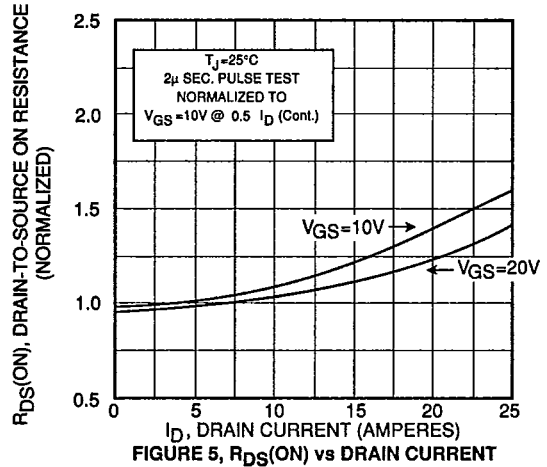
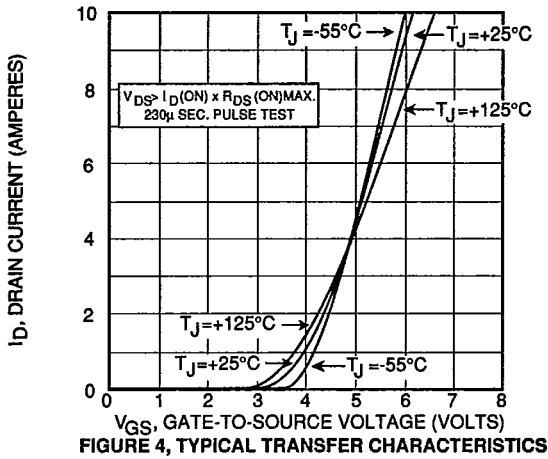
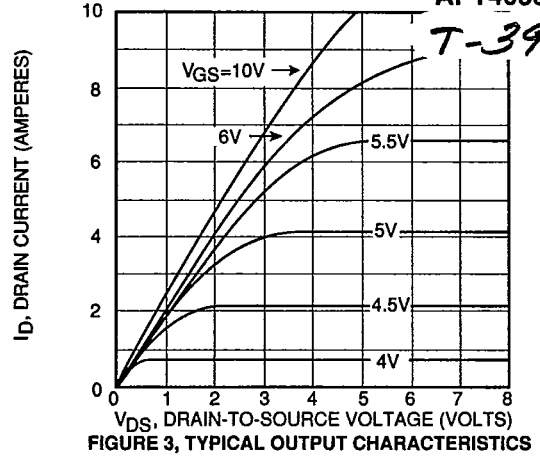
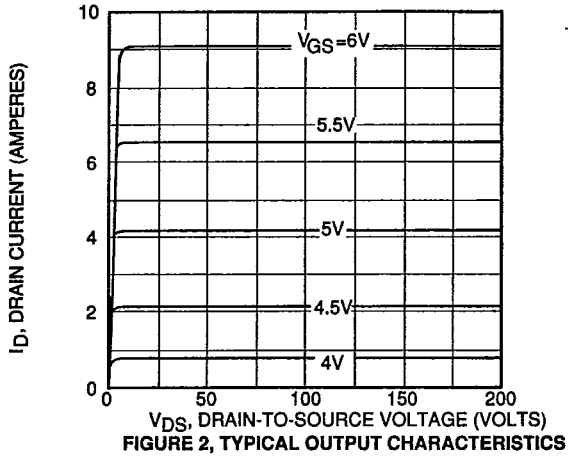

FIGURE 1, MAXIMUM EFFECTIVE TRANSIENT THERMAL IMPEDANCE, JUNCTION-TO-CASE vs PULSE DURATION

T-39-13



APT4055/3555AN

T-39-13

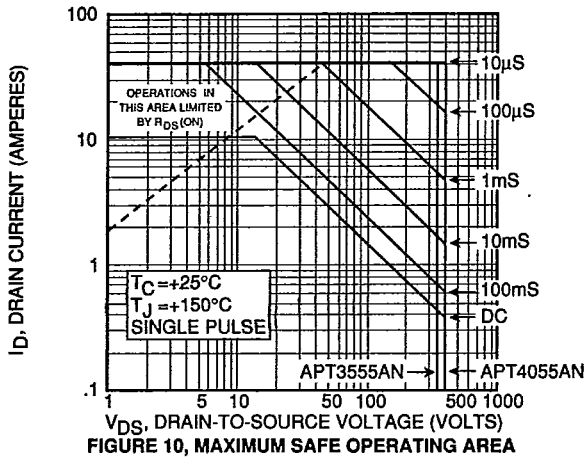

FIGURE 10, MAXIMUM SAFE OPERATING AREA

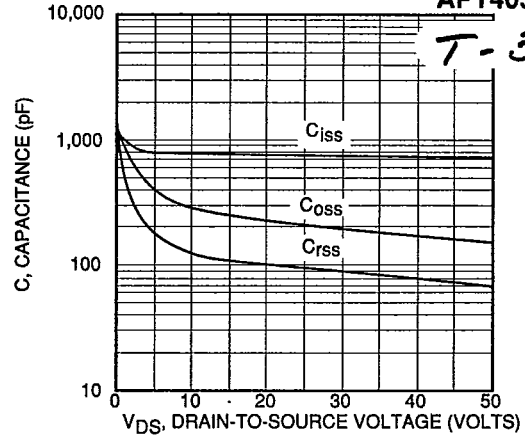

FIGURE 11, TYPICAL CAPACITANCE vs DRAIN-TO-SOURCE VOLTAGE

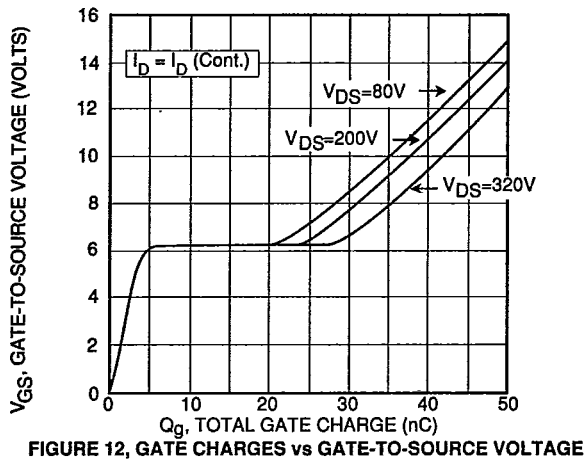

FIGURE 12, GATE CHARGES vs GATE-TO-SOURCE VOLTAGE

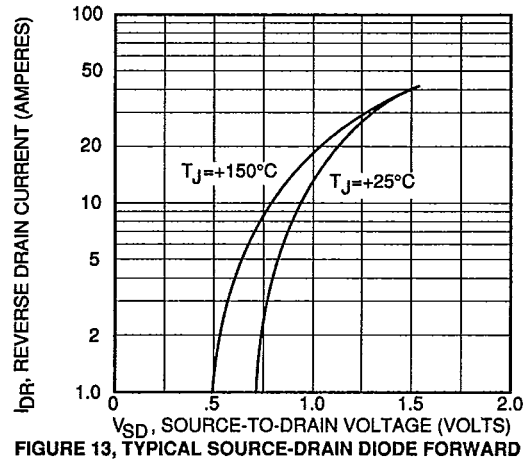
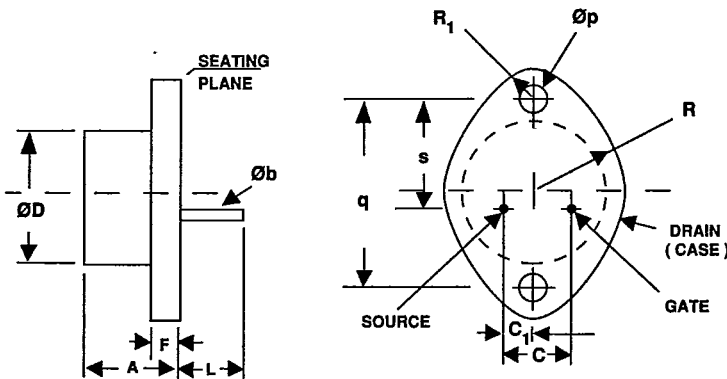

FIGURE 13, TYPICAL SOURCE-DRAIN DIODE FORWARD VOLTAGE

TO-3 Schematic (TO-204AA)



SYMBOL	INCHES		MILLIMETERS		NOTES
	MIN.	MAX.	MIN.	MAX.	
A	.250	.360	6.35	9.15	2
Øb	.038	.043	.97	1.10	
ØD		.875		22.23	2
C	.420	.440	10.67	11.18	
C1	.205	.225	5.21	5.72	2
F	.060	.135	1.52	3.43	
L	.312	.500	7.92	12.70	2
Øp	.151	.161	3.84	4.09	
q	1.177	1.197	29.90	30.40	2
R	.495	.525	12.57	13.34	
R1	.131	.188	3.33	4.78	1
s	.655	.675	16.64	17.15	

Notes:

1. These dimensions should be measured at points .050" (1.27 mm) to .55" (1.40 mm) below seating plane. When gate is not used, measurement will be made at seating plane.
2. Two leads.

APT PART NUMBERING SYSTEM - EXAMPLES

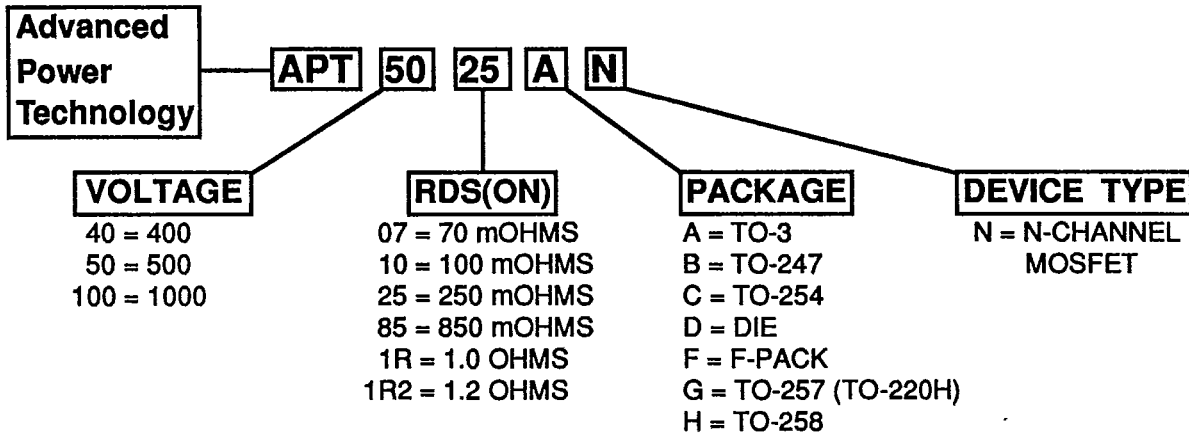

PACKAGE OUTLINES

Package A TO-3 (TO-204AA)

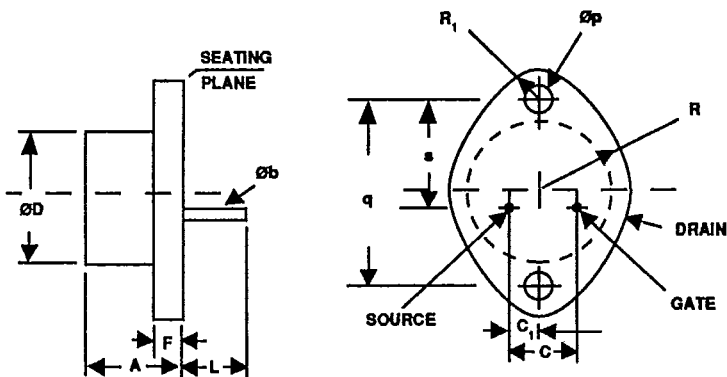

SYMBOL	INCHES		MILLIMETERS		NOTES
	MIN.	MAX.	MIN.	MAX.	
A	.250	.360	6.35	9.15	
Øb	.038	.043	.97	1.10	2
ØD		.875		22.23	
C	.420	.440	10.67	11.18	
C 1	.205	.225	5.21	5.72	
F	.060	.135	1.52	3.43	
L	.312	.500	7.92	12.70	2
Øp	.151	.161	3.84	4.09	
q	1.177	1.197	29.90	30.40	
R	.495	.525	12.57	13.34	
R 1	.131	.188	3.33	4.78	
s	.655	.675	16.64	17.15	1

Notes:

1. These dimensions should be measured at points .050" (1.27 mm) to .55" (1.40 mm) below seating plane. When gate is not used, measurement will be made at seating plane.
2. Two leads.

Package B TO-3P (TO-247 Type AD Proposed)

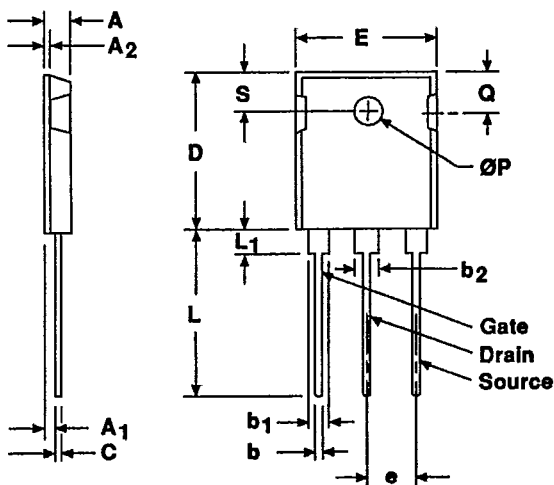

SYMBOL	INCHES		MILLIMETERS		NOTES
	MIN	MAX	MIN	MAX	
A	.185	.209	4.69	5.31	
A 1	.087	.102	2.21	2.59	
A 2	.059	.098	1.49	2.49	
b	.040	.055	1.01	1.40	4
b 1	.065	.084	1.65	2.13	4
b 2	.113	.123	2.87	3.12	
D	.016	.031	0.40	0.79	
E	.819	.845	20.80	21.46	
L	.610	.640	15.49	16.26	
e	.215 BSC		5.25 BSC		
L 1	.780	.800	19.81	20.32	
L 1		.177		4.50	4
ØP	.140	.144	3.55	3.66	
Q	.212	.244	5.38	6.20	
S	.242 BSC		6.15 BSC		

Notes:

1. Refer to applicable symbol list.
2. Dimensions and tolerances per ANSI V14.5, 1982.
3. Maximum radius of .050 on all boot edges and corners.
4. Lead dimensions uncontrolled in L
5. Controlling dimension: Metric.

PACKAGE OUTLINES (Continued)

Package G TO-257AA (TO-220 Herm.)

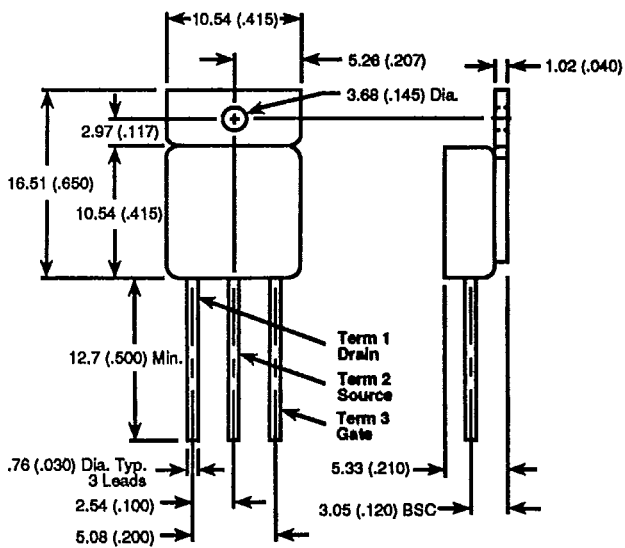

Package C TO-254AA

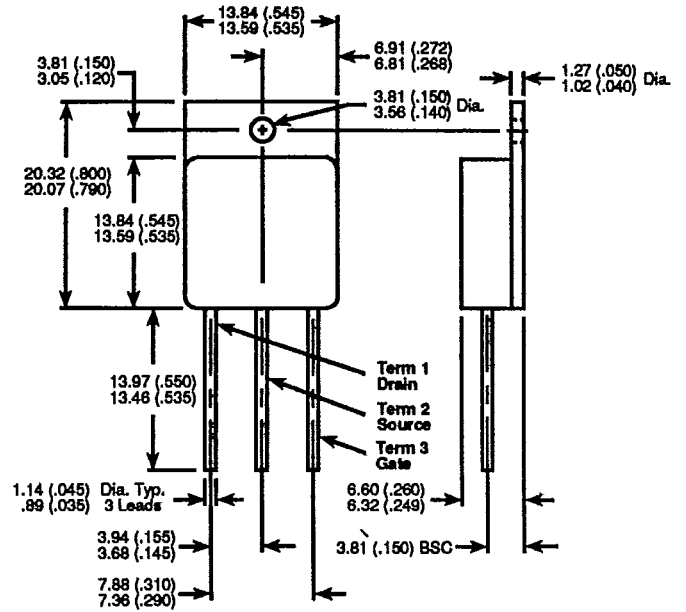

Package H TO-258AA (TO-247 Herm.)

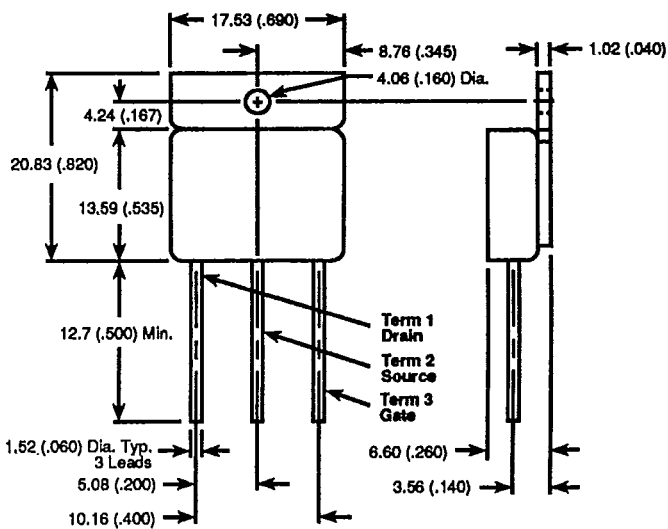

Package F (F-Pack)

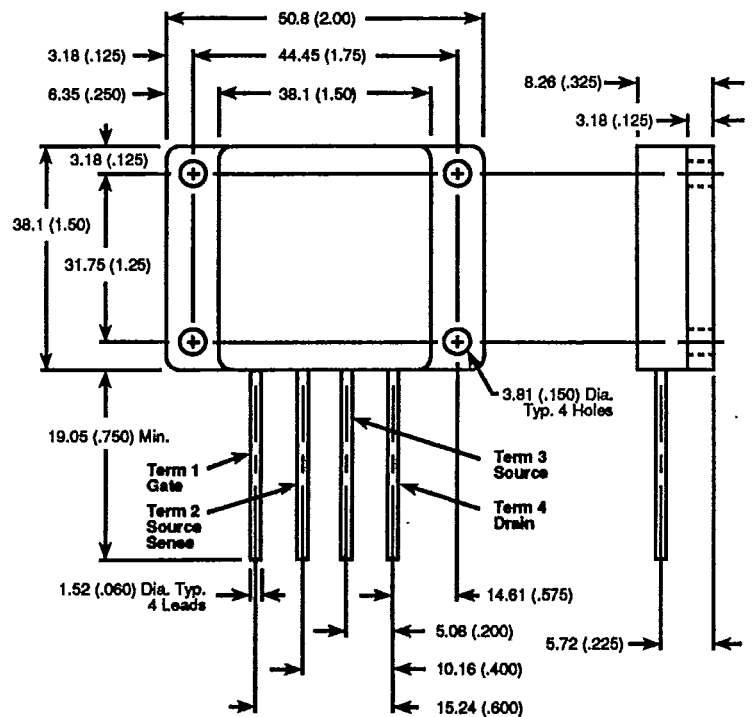

DIE TOPOGRAPHICAL LAYOUT DETAILS FOR APT POWER MOS IV™ DIE

APT - 104 = .199 x .203 In.

- Source Pads = .036 In. diam
- Gate pads = .018 x .019 In.

Letters = Internal dimensions
 A = .081 In. B = .039 In. C = .018 In.
 D = .040 In. E = .082 In.

APT - 105 = .290 x .250 In.

- Source Pads = .036 In. diam
- Gate pads = .018 x .019 In.

Letters = Internal dimensions
 A = .055 In. B = .085 In. C = .105 In.
 D = .042 In. E = .018 In.

APT - 101 = .320 x .320 In.

- ▨ Source Pads = .037 x .024 In.
- ▩ Source Pads = .030 x .024 In.
- Gate pads = .014 x .019 In.

Letters = Internal dimensions
 A = .077 In. B = .062 In. C = .048 In.
 D = .149 In. E = .018 In.

APT - 102 = .414 x .254 In.

- Source Pads = .036 In. diam
- Gate pads = .012 x .019 In.

Letters = Internal dimensions
 A = .117 In. B = .037 In. C = .097 In.
 D = .031 In. E = .046 In.

APT - 107 = .588 x .388 In.

- Source pads = .036
- Gate pads = .017 x .018

Letters = Internal dimensions
 A = .057 In. B = .240 In. C = .151 In.
 D = .045 In. E = .017 In. F = .091 In. G = .088 In.

A