



The Infinite Bandwidth Company™

MIC4416/4417

IttyBitty™ Low-Side MOSFET Driver

Final Information

General Description

The MIC4416 and MIC4417 IttyBitty™ low-side MOSFET drivers are designed to switch an N-channel enhancement-type MOSFET from a TTL-compatible control signal in low-side switch applications. The MIC4416 is noninverting and the MIC4417 is inverting. These drivers feature short delays and high peak current to produce precise edges and rapid rise and fall times. Their tiny 4-lead SOT-143 package uses minimum space.

The MIC4416/7 is powered from a +4.5V to +18V supply voltage. The on-state gate drive output voltage is approximately equal to the supply voltage (no internal regulators or clamps). High supply voltages, such as 10V, are appropriate for use with standard N-channel MOSFETs. Low supply voltages, such as 5V, are appropriate for use with logic-level N-channel MOSFETs.

In a low-side configuration, the driver can control a MOSFET that switches any voltage up to the rating of the MOSFET.

The MIC4416 is available in the SOT-143 package and is rated for -40°C to +85°C ambient temperature range.

Features

- +4.5V to +18V operation
- Low steady-state supply current
50µA typical, control input low
370µA typical, control input high
- 1.2A nominal peak output
3.5Ω typical output resistance at 18V supply
7.8Ω typical output resistance at 5V supply
- 25mV maximum output offset from supply or ground
- Operates in low-side switch circuits
- TTL-compatible input withstands -20V
- ESD protection
- Inverting and noninverting versions

Applications

- Battery conservation
- Solenoid and motion control
- Lamp control
- Switch-mode power supplies

Ordering Information

Part Number	Temp. Range	Package	Marking
Noninverting			
MIC4416BM4	-40°C to +85°C	SOT-143	D10
Inverting			
MIC4417BM4	-40°C to +85°C	SOT-143	D11

Typical Application

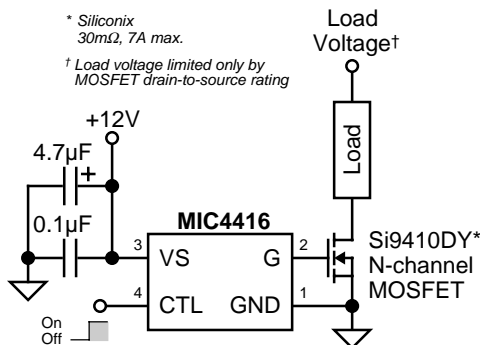

Low-Side Power Switch

Pin Configuration

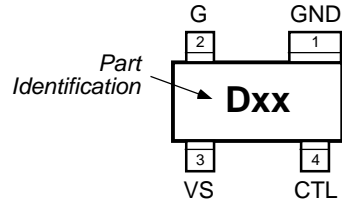

Part Number	Identification
MIC4416BM4	D10
MIC4417BM4	D11

Early production identification: ML10

SOT-143 (M4)

Pin Description

Pin Number	Pin Name	Pin Function
1	GND	Ground: Power return.
2	G	Gate (Output) : Gate connection to external MOSFET.
3	VS	Supply (Input): +4.5V to +18V supply.
4	CTL	Control (Input): TTL-compatible on/off control input. <i>MIC4416 only:</i> Logic high forces the gate output to the supply voltage. Logic low forces the gate output to ground. <i>MIC4417 only:</i> Logic high forces the gate output to ground. Logic low forces the gate output to the supply voltage.

Absolute Maximum Ratings

Supply Voltage (V_S)	+20V
Control Voltage (V_{CTL})	-20V to +20V
Gate Voltage (V_G)	+20V
Junction Temperature (T_J)	150°C
Lead Temperature, Soldering	260°C for 5 sec.

Operating Ratings

Supply Voltage (V_S)	+4.5 to +18V
Control Voltage (V_{CTL})	0V to V_S
Ambient Temperature Range (T_A)	-40°C to +85°C
Thermal Resistance (θ_{JA})	220°C/W (soldered to 0.25in ² copper ground plane)

Electrical Characteristics

Parameter	Condition (Note 1)	Min	Typ	Max	Units
Supply Current	$4.5V \leq V_S \leq 18V$ $V_{CTL} = 0V$ $V_{CTL} = 5V$		50 370	200 1500	μA μA
Control Input Voltage	$4.5V \leq V_S \leq 18V$ V_{CTL} for logic 0 input V_{CTL} for logic 1 input	2.4		0.8	V V
Control Input Current	$0V \leq V_{CTL} \leq V_S$	-10		10	μA
Delay Time, V_{CTL} Rising	$V_S = 5V$ $C_L = 1000pF$, Note 2		42		ns
	$V_S = 18V$ $C_L = 1000pF$, Note 2		33	60	ns
Delay Time, V_{CTL} Falling	$V_S = 5V$ $C_L = 1000pF$, Note 2		42		ns
	$V_S = 18V$ $C_L = 1000pF$, Note 2		23	40	ns
Output Rise Time	$V_S = 5V$ $C_L = 1000pF$, Note 2		24		ns
	$V_S = 18V$ $C_L = 1000pF$, Note 2		14	40	ns
Output Fall Time	$V_S = 5V$ $C_L = 1000pF$, Note 2		28		ns
	$V_S = 18V$ $C_L = 1000pF$, Note 2		16	40	ns
Gate Output Offset Voltage	$4.5V \leq V_S \leq 18V$ $V_G = \text{high}$ $V_G = \text{low}$		-25 25		mV mV
Output Resistance	$V_S = 5V$, $I_{OUT} = 10mA$ P-channel (source) MOSFET N-channel (sink) MOSFET		7.6 7.8		Ω Ω
	$V_S = 18V$, $I_{OUT} = 10mA$ P-channel (source) MOSFET N-channel (sink) MOSFET		3.5 3.5	10 10	Ω Ω
Gate Output Reverse Current	No latch up	250			mA

General Note: Devices are ESD protected, however handling precautions are recommended.

Note 1: Typical values at $T_A = 25^\circ C$. Minimum and maximum values indicate performance at $-40^\circ C \geq T_A \geq +85^\circ C$. Parts production tested at $25^\circ C$.

Note 2: Refer to "MIC4416 Timing Definitions" and "MIC4417 Timing Definitions" diagrams (see next page).

Definitions

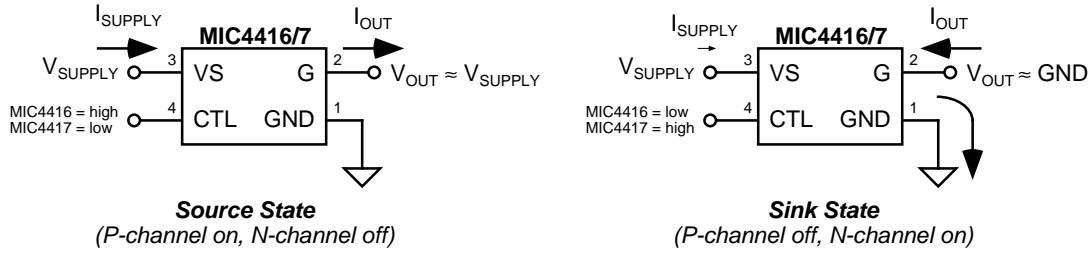

MIC4416/MIC4417 Operating States

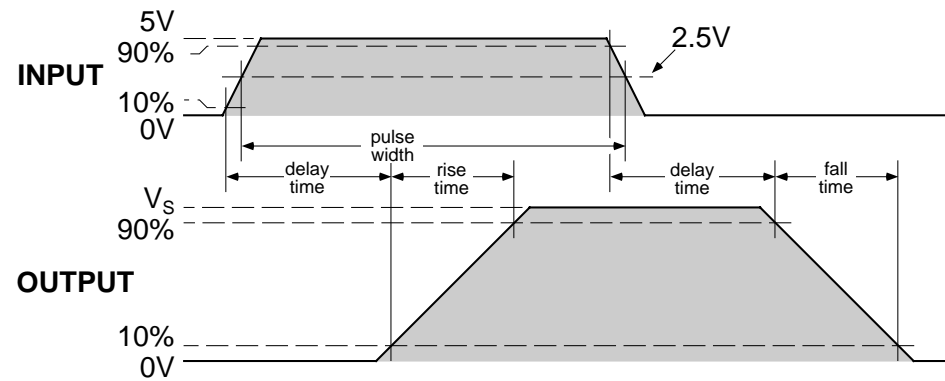

MIC4416 (Noninverting) Timing Definitions

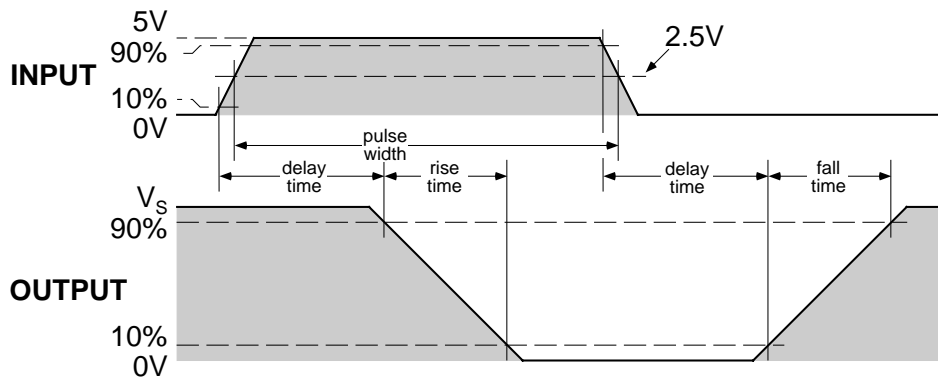

MIC4417 (Inverting) Timing Definitions

Test Circuit

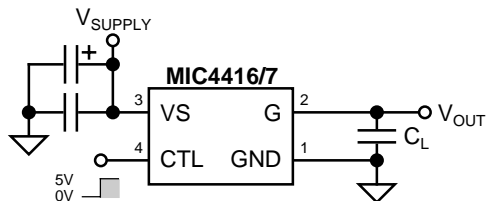

Typical Characteristics Note 3

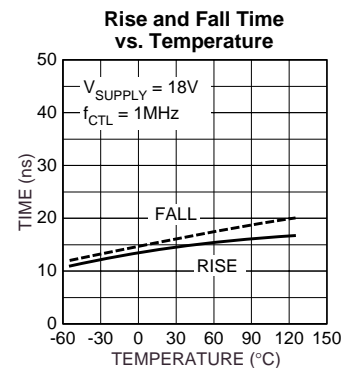
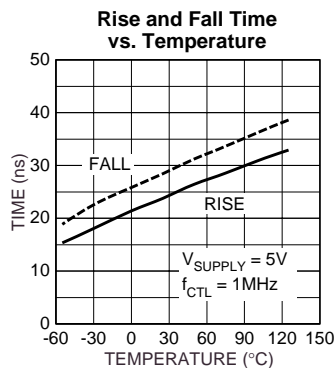
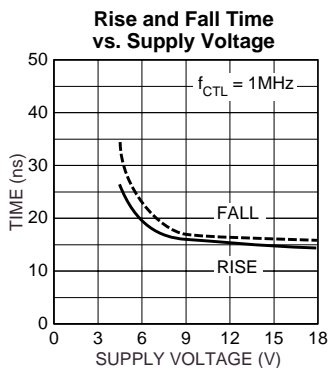
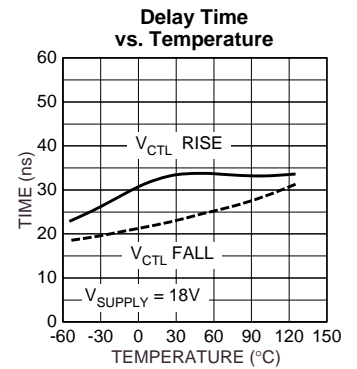
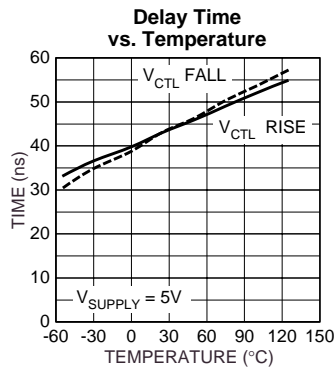
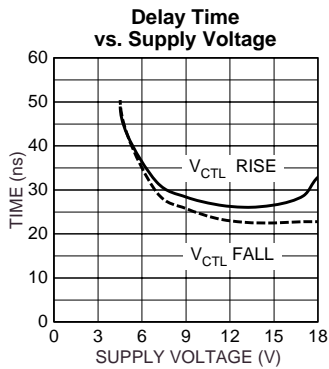
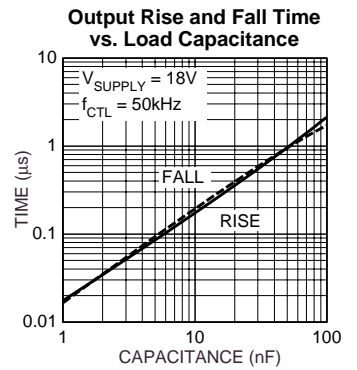
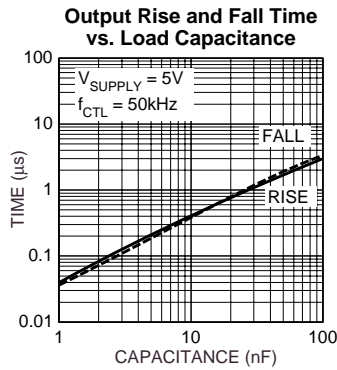
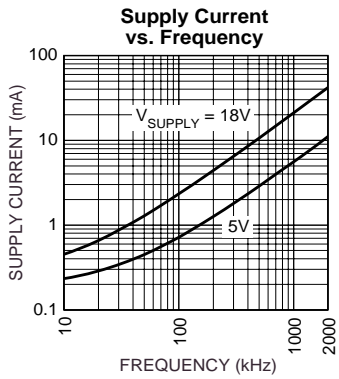
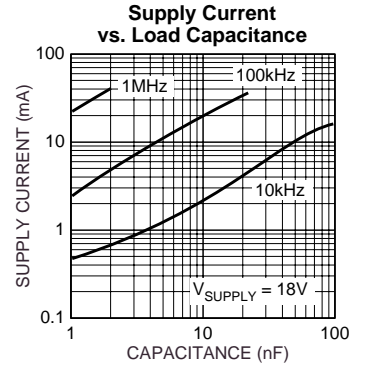
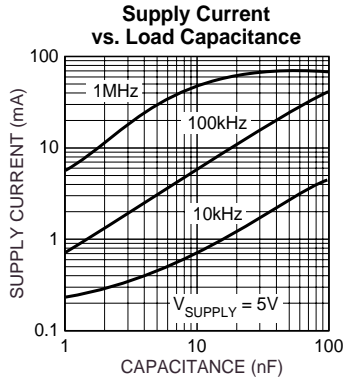
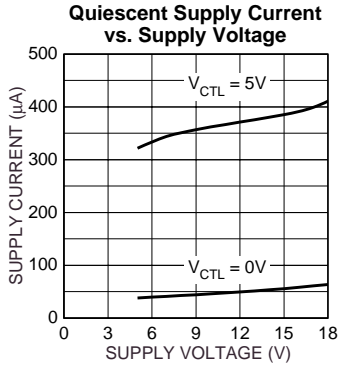

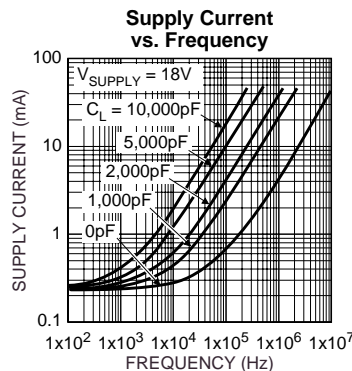
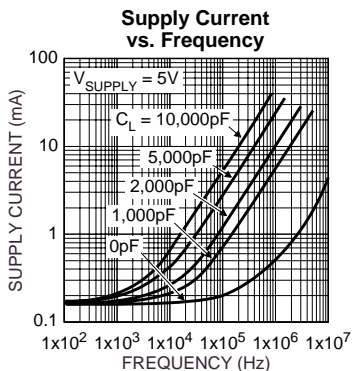
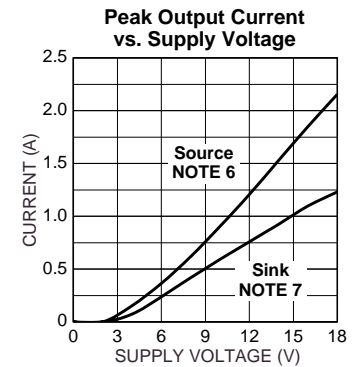
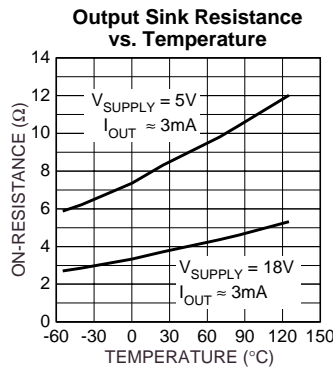
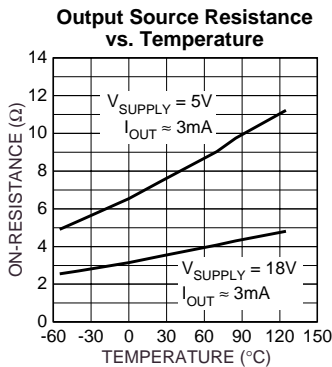
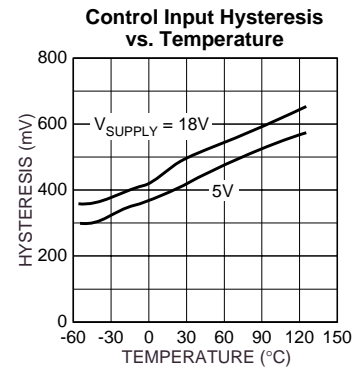
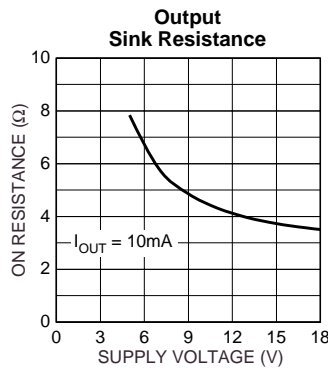
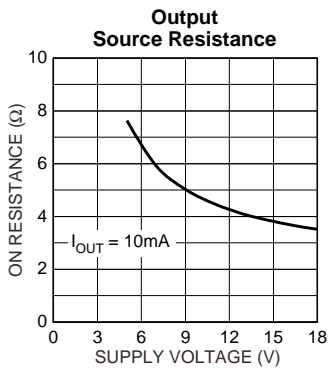
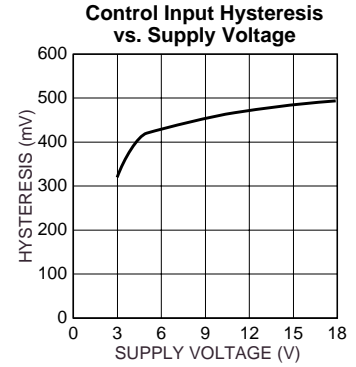
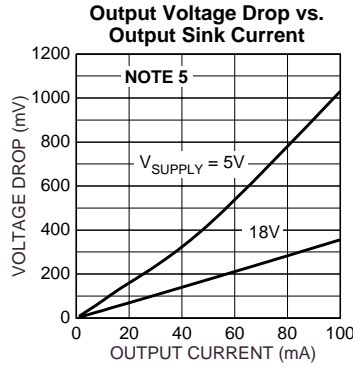
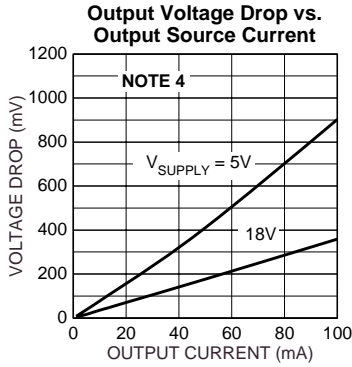

- Note 3:** Typical Characteristics at T_A = 25°C, V_S = 5V, C_L = 1000pF unless noted.
- Note 4:** Source-to-drain voltage drop across the internal P-channel MOSFET = V_S - V_G.
- Note 5:** Drain-to-source voltage drop across the internal N-channel MOSFET = V_G - V_{GND}. (Voltage applied to G.)
- Note 6:** 1μs pulse test, 50% duty cycle. OUT connected to GND. OUT sources current. (MIC4416, V_{CTL} = 5V; MIC4417, V_{CTL} = 0V)
- Note 7:** 1μs pulse test, 50% duty cycle. VS connected to OUT. OUT sinks current. (MIC4416, V_{CTL} = 0V; MIC4417, V_{CTL} = 5V)

Functional Diagram

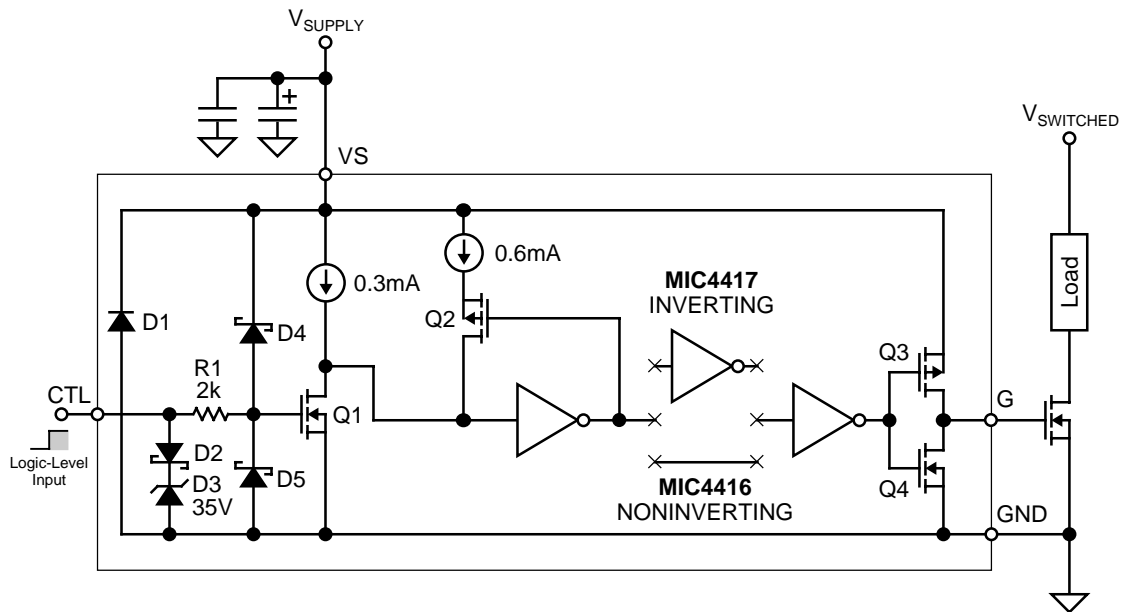

Functional Diagram with External Components

Functional Description

Refer to the functional diagram.

The MIC4416 is a noninverting driver. A logic high on the CTL (control) input produces gate drive output. The MIC4417 is an inverting driver. A logic low on the CTL (control) input produces gate drive output. The G (gate) output is used to turn on an external N-channel MOSFET.

Supply

VS (supply) is rated for +4.5V to +18V. External capacitors are recommended to decouple noise.

Control

CTL (control) is a TTL-compatible input. CTL must be forced high or low by an external signal. A floating input will cause unpredictable operation.

A high input turns on Q1, which sinks the output of the 0.3mA and the 0.6mA current source, forcing the input of the first inverter low.

Hysteresis

The control threshold voltage, when CTL is rising, is slightly higher than the control threshold voltage when CTL is falling.

When CTL is low, Q2 is on, which applies the additional 0.6mA current source to Q1. Forcing CTL high turns on Q1 which must sink 0.9mA from the two current sources. The higher current through Q1 causes a larger drain-to-source voltage drop across Q1. A slightly higher control voltage is required to pull the input of the first inverter down to its threshold.

Q2 turns off after the first inverter output goes high. This reduces the current through Q1 to 0.3mA. The lower current reduces the drain-to-source voltage drop across Q1. A slightly lower control voltage will pull the input of the first inverter up to its threshold.

Drivers

The second (optional) inverter permits the driver to be manufactured in inverting and noninverting versions.

The last inverter functions as a driver for the output MOSFETs Q3 and Q4.

Gate Output

G (gate) is designed to drive a capacitive load. V_G (gate output voltage) is either approximately the supply voltage or approximately ground, depending on the logic state applied to CTL.

If CTL is high, and VS (supply) drops to zero, the gate output will be floating (unpredictable).

ESD Protection

D1 protects VS from negative ESD voltages. D2 and D3 clamp positive and negative ESD voltages applied to CTL. R1 isolates the gate of Q1 from sudden changes on the CTL input. D4 and D5 prevent Q1's gate voltage from exceeding the supply voltage or going below ground.

Application Information

The MIC4416/7 is designed to provide high peak current for charging and discharging capacitive loads. The 1.2A peak value is a nominal value determined under specific conditions. This nominal value is used to compare its relative size to other low-side MOSFET drivers. The MIC4416/7 is not designed to directly switch 1.2A continuous loads.

Supply Bypass

Capacitors from VS to GND are recommended to control switching and supply transients. Load current and supply lead length are some of the factors that affect capacitor size requirements.

A 4.7 μ F or 10 μ F tantalum capacitor is suitable for many applications. Low-ESR (equivalent series resistance) metalized film capacitors may also be suitable. An additional 0.1 μ F ceramic capacitor is suggested in parallel with the larger capacitor to control high-frequency transients.

The low ESR (equivalent series resistance) of tantalum capacitors makes them especially effective, but also makes them susceptible to uncontrolled inrush current from low impedance voltage sources (such as NiCd batteries or automatic test equipment). Avoid instantaneously applying voltage, capable of very high peak current, directly to or near tantalum capacitors without additional current limiting. Normal power supply turn-on (slow rise time) or printed circuit trace resistance is usually adequate for normal product usage.

Circuit Layout

Avoid long power supply and ground traces. They exhibit inductance that can cause voltage transients (inductive kick). Even with resistive loads, inductive transients can sometimes exceed the ratings of the MOSFET and the driver.

When a load is switched off, supply lead inductance forces current to continue flowing—resulting in a positive voltage spike. Inductance in the ground (return) lead to the supply has similar effects, except the voltage spike is negative.

Switching transitions momentarily draw current from VS to GND. This combines with supply lead inductance to create voltage transients at turn on and turnoff.

Transients can also result in slower apparent rise or fall times when driver's ground shifts with respect to the control input.

Minimize the length of supply and ground traces or use ground and power planes when possible. Bypass capacitors should be placed as close as practical to the driver.

MOSFET Selection

Standard MOSFET

A standard N-channel power MOSFET is fully enhanced with a gate-to-source voltage of approximately 10V and has an absolute maximum gate-to-source voltage of ± 20 V.

The MIC4416/7's on-state output is approximately equal to the supply voltage. The lowest usable voltage depends upon the behavior of the MOSFET.

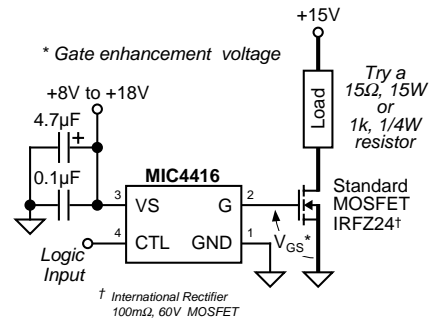

Figure 1. Using a Standard MOSFET

Logic-Level MOSFET

Logic-level N-channel power MOSFETs are fully enhanced with a gate-to-source voltage of approximately 5V and have an absolute maximum gate-to-source voltage of ± 10 V. They are less common and generally more expensive.

The MIC4416/7 can drive a logic-level MOSFET if the supply voltage, including transients, does not exceed the maximum MOSFET gate-to-source rating (10V).

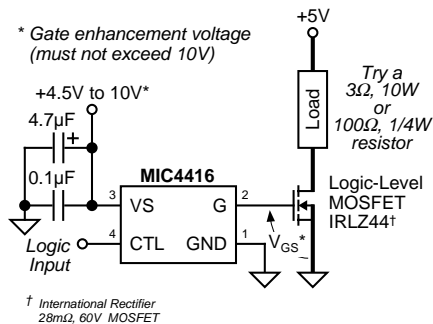

Figure 2. Using a Logic-Level MOSFET

At low voltages, the MIC4416/7's internal P- and N-channel MOSFET's on-resistance will increase and slow the output rise time. Refer to "Typical Characteristics" graphs.

Inductive Loads

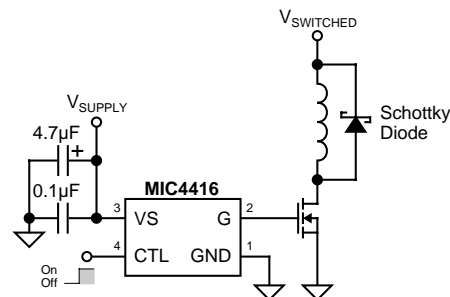

Figure 3. Switching an Inductive Load

Switching off an inductive load in a low-side application forces the MOSFET drain higher than the supply voltage (as the inductor resists changes to current). To prevent exceeding the MOSFET's drain-to-gate and drain-to-source ratings, a Schottky diode should be connected across the inductive load.

Power Dissipation

The maximum power dissipation must not be exceeded to prevent die meltdown or deterioration.

Power dissipation in on/off switch applications is negligible.

Fast repetitive switching applications, such as SMPS (switch-mode power supplies), cause a significant increase in power dissipation with frequency. Power is dissipated each time current passes through the internal output MOSFETs when charging or discharging the external MOSFET. Power is also dissipated during each transition when some current momentarily passes from VS to GND through both internal MOSFETs.

Power dissipation is the product of supply voltage and supply current:

$$1) \quad P_D = V_S \times I_S$$

where:

P_D = power dissipation (W)

V_S = supply voltage (V)

I_S = supply current (A) [see paragraph below]

Supply current is a function of supply voltage, switching frequency, and load capacitance. Determine this value from the "Typical Characteristics: Supply Current vs. Frequency" graph or measure it in the actual application.

Do not allow P_D to exceed $P_{D(max)}$ below.

T_J (junction temperature) is the sum of T_A (ambient temperature) and the temperature rise across the thermal resistance of the package. In another form:

$$2) \quad P_D \leq \frac{150 - T_A}{220}$$

where:

$P_{D(max)}$ = maximum power dissipation (W)

150 = absolute maximum junction temperature (°C)

T_A = ambient temperature (°C) [68°F = 20°C]

220 = package thermal resistance (°C/W)

Maximum power dissipation at 20°C with the driver soldered to a 0.25in² ground plane is approximately 600mW.

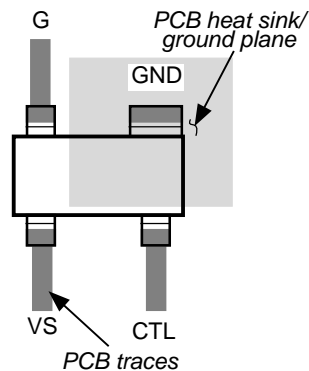

Figure 4. Heat-Sink Plane

The SOT-143 package θ_{JA} (junction-to-ambient thermal resistance) can be improved by using a heat sink larger than the specified 0.25in² ground plane. Significant heat transfer occurs through the large (GND) lead. This lead is an extension of the paddle to which the die is attached.

High-Frequency Operation

Although the MIC4416/7 driver will operate at frequencies greater than 1MHz, the MOSFET's capacitance and the load will affect the output waveform (at the MOSFET's drain).

For example, an MIC4416/IRL3103 test circuit using a 47Ω 5W load resistor will produce an output waveform that closely matches the input signal shape up to about 500kHz. The same test circuit with a 1kΩ load resistor operates only up to about 25kHz before the MOSFET source waveform shows significant change.

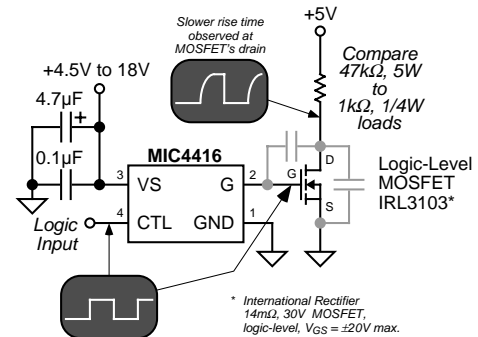
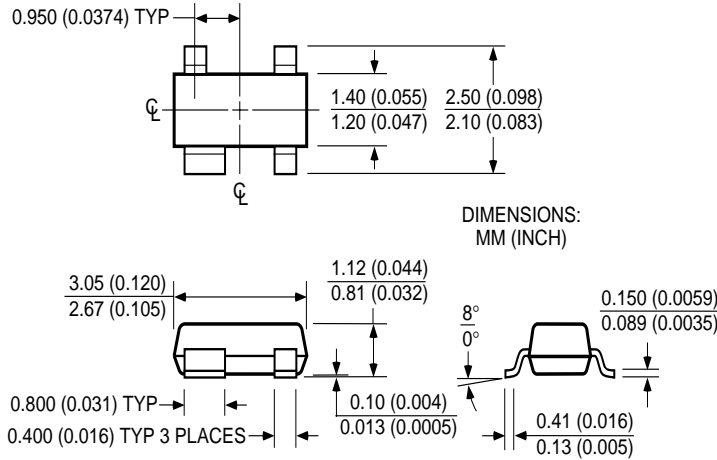

Figure 5. MOSFET Capacitance Effects at High Switching Frequency

When the MOSFET is driven off, the slower rise occurs because the MOSFET's output capacitance recharges through the load resistance (RC circuit). A lower load resistance allows the output to rise faster. For the fastest driver operation, choose the smallest power MOSFET that will safely handle the desired voltage, current, and safety margin. The smallest MOSFETs generally have the lowest capacitance.

Package Information



4-Pin SOT-143 (M4)

MICREL INC. 1849 FORTUNE DRIVE SAN JOSE, CA 95131 USA

TEL + 1 (408) 944-0800 FAX + 1 (408) 944-0970 WEB <http://www.micrel.com>

This information is believed to be accurate and reliable, however no responsibility is assumed by Micrel for its use nor for any infringement of patents or other rights of third parties resulting from its use. No license is granted by implication or otherwise under any patent or patent right of Micrel Inc.

© 2001 Micrel Incorporated