

HEXFET<sup>®</sup> Power MOSFET

- Generation V Technology
- Ultra Low On-Resistance
- Dual N and P Channel MOSFET
- Surface Mount
- Fully Avalanche Rated

**Description**

Fifth Generation HEXFETs from International Rectifier utilize advanced processing techniques to achieve extremely low on-resistance per silicon area. This benefit, combined with the fast switching speed and ruggedized device design that HEXFET Power MOSFETs are well known for, provides the designer with an extremely efficient and reliable device for use in a wide variety of applications.

The SO-8 has been modified through a customized leadframe for enhanced thermal characteristics and multiple-die capability making it ideal in a variety of power applications. With these improvements, multiple devices can be used in an application with dramatically reduced board space. The package is designed for vapor phase, infra red, or wave soldering techniques.

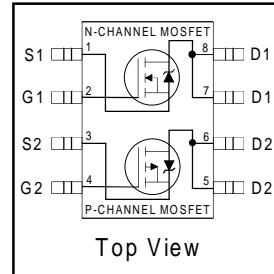

	N-Ch	P-Ch
$V_{DS}$	20V	-20V
$R_{DS(on)}$	0.029 $\Omega$	0.058 $\Omega$

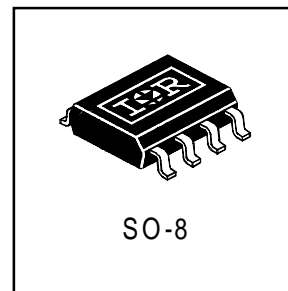

**Absolute Maximum Ratings (  $T_A = 25^\circ\text{C}$  Unless Otherwise Noted)**

	Symbol	Maximum		Units	
		N-Channel	P-Channel		
Drain-Source Voltage	$V_{DS}$	20	-20	V	
Gate-Source Voltage	$V_{GS}$	$\pm 12$			
Continuous Drain Current <sup>⑤</sup>	$I_D$	$T_A = 25^\circ\text{C}$	6.6	-5.3	A
		$T_A = 70^\circ\text{C}$	5.3	-4.3	
Pulsed Drain Current	$I_{DM}$		26	-21	
Continuous Source Current (Diode Conduction)	$I_S$		2.5	-2.5	
Maximum Power Dissipation <sup>⑤</sup>	$P_D$	$T_A = 25^\circ\text{C}$	2.0		W
		$T_A = 70^\circ\text{C}$	1.3		
Single Pulse Avalanche Energy	$E_{AS}$	100	150	mJ	
Avalanche Current	$I_{AR}$	4.1	-2.9	A	
Repetitive Avalanche Energy	$E_{AR}$	0.20		mJ	
Peak Diode Recovery $dv/dt$ <sup>②</sup>	$dv/dt$	5.0	-5.0	V/ ns	
Junction and Storage Temperature Range	$T_J, T_{STG}$	-55 to + 150 °C			

**Thermal Resistance Ratings**

Parameter	Symbol	Limit	Units
Maximum Junction-to-Ambient <sup>⑤</sup>	$R_{\theta JA}$	62.5	$^\circ\text{C/W}$

## Electrical Characteristics @ T<sub>J</sub> = 25°C (unless otherwise specified)

Parameter	Description		Min.	Typ.	Max.	Units	Conditions
V <sub>(BR)DSS</sub>	Drain-to-Source Breakdown Voltage	N-Ch	20	—	—	V	V <sub>GS</sub> = 0V, I <sub>D</sub> = 250μA
		P-Ch	-20	—	—		V <sub>GS</sub> = 0V, I <sub>D</sub> = -250μA
ΔV <sub>(BR)DSS</sub> /ΔT <sub>J</sub>	Breakdown Voltage Temp. Coefficient	N-Ch	—	0.027	—	V/°C	Reference to 25°C, I <sub>D</sub> = 1mA
		P-Ch	—	0.031	—		Reference to 25°C, I <sub>D</sub> = -1mA
R <sub>DS(ON)</sub>	Static Drain-to-Source On-Resistance	N-Ch	—	0.023	0.029	Ω	V <sub>GS</sub> = 4.5V, I <sub>D</sub> = 6.0A ④
			—	0.030	0.046		V <sub>GS</sub> = 2.7V, I <sub>D</sub> = 5.2A ④
		P-Ch	—	0.049	0.058		V <sub>GS</sub> = -4.5V, I <sub>D</sub> = -2.9A ④
			—	0.082	0.098		V <sub>GS</sub> = -2.7V, I <sub>D</sub> = -1.5A ④
V <sub>GS(th)</sub>	Gate Threshold Voltage	N-Ch	0.7	—	—	V	V <sub>DS</sub> = V <sub>GS</sub> , I <sub>D</sub> = 250μA
		P-Ch	-0.7	—	—		V <sub>DS</sub> = V <sub>GS</sub> , I <sub>D</sub> = -250μA
g <sub>fs</sub>	Forward Transconductance	N-Ch	—	20	—	S	V <sub>DS</sub> = 10V, I <sub>D</sub> = 6.0A ④
		P-Ch	—	5.9	—		V <sub>DS</sub> = -10V, I <sub>D</sub> = -1.5A ④
I <sub>DSS</sub>	Drain-to-Source Leakage Current	N-Ch	—	—	1.0	μA	V <sub>DS</sub> = 16V, V <sub>GS</sub> = 0V
		P-Ch	—	—	-1.0		V <sub>DS</sub> = -16V, V <sub>GS</sub> = 0V
		N-Ch	—	—	5.0		V <sub>DS</sub> = 16V, V <sub>GS</sub> = 0V, T <sub>J</sub> = 55°C
		P-Ch	—	—	-25		V <sub>DS</sub> = -16V, V <sub>GS</sub> = 0V, T <sub>J</sub> = 55°C
I <sub>GSS</sub>	Gate-to-Source Forward Leakage	N-P	—	—	±100	nA	V <sub>GS</sub> = ±12V
Q <sub>g</sub>	Total Gate Charge	N-Ch	—	18	27	nC	N-Channel I <sub>D</sub> = 6.0A, V <sub>DS</sub> = 10V, V <sub>GS</sub> = 4.5V
		P-Ch	—	19	29		④
Q <sub>gs</sub>	Gate-to-Source Charge	N-Ch	—	2.2	3.3	nC	
		P-Ch	—	4.0	6.1		
Q <sub>gd</sub>	Gate-to-Drain ("Miller") Charge	N-Ch	—	6.2	9.3	nC	P-Channel I <sub>D</sub> = -2.9A, V <sub>DS</sub> = -16V, V <sub>GS</sub> = -4.5V
		P-Ch	—	7.7	12		
t <sub>d(on)</sub>	Turn-On Delay Time	N-Ch	—	8.1	12	ns	N-Channel V <sub>DD</sub> = 10V, I <sub>D</sub> = 1.0A, R <sub>G</sub> = 6.0Ω, R <sub>D</sub> = 10Ω
		P-Ch	—	15	22		④
t <sub>r</sub>	Rise Time	N-Ch	—	17	25	ns	
		P-Ch	—	40	60		
t <sub>d(off)</sub>	Turn-Off Delay Time	N-Ch	—	38	57	ns	P-Channel V <sub>DD</sub> = -10V, I <sub>D</sub> = -2.9A, R <sub>G</sub> = 6.0Ω, R <sub>D</sub> = 3.4Ω
		P-Ch	—	42	63		
t <sub>f</sub>	Fall Time	N-Ch	—	31	47	ns	
		P-Ch	—	49	73		
C <sub>iss</sub>	Input Capacitance	N-Ch	—	900	—	pF	N-Channel V <sub>GS</sub> = 0V, V <sub>DS</sub> = 15V, f = 1.0MHz
		P-Ch	—	780	—		
C <sub>oss</sub>	Output Capacitance	N-Ch	—	430	—	pF	P-Channel V <sub>GS</sub> = 0V, V <sub>DS</sub> = -15V, f = 1.0MHz
		P-Ch	—	470	—		
C <sub>rss</sub>	Reverse Transfer Capacitance	N-Ch	—	200	—	pF	
		P-Ch	—	240	—		

## Source-Drain Ratings and Characteristics

Parameter	Description		Min.	Typ.	Max.	Units	Conditions
I <sub>S</sub>	Continuous Source Current (Body Diode)	N-Ch	—	—	2.5	A	
		P-Ch	—	—	-2.5		
I <sub>SM</sub>	Pulsed Source Current (Body Diode) ①	N-Ch	—	—	26	A	
		P-Ch	—	—	-21		
V <sub>SD</sub>	Diode Forward Voltage	N-Ch	—	0.72	1.0	V	T <sub>J</sub> = 25°C, I <sub>S</sub> = 1.7A, V <sub>GS</sub> = 0V ③
		P-Ch	—	-0.78	-1.0		T <sub>J</sub> = 25°C, I <sub>S</sub> = -2.9A, V <sub>GS</sub> = 0V ③
t <sub>rr</sub>	Reverse Recovery Time	N-Ch	—	52	77	ns	N-Channel T <sub>J</sub> = 25°C, I <sub>F</sub> = 1.7A, di/dt = 100A/μs
		P-Ch	—	47	71		④
Q <sub>rr</sub>	Reverse Recovery Charge	N-Ch	—	58	86	nC	P-Channel T <sub>J</sub> = 25°C, I <sub>F</sub> = -2.9A, di/dt = 100A/μs
		P-Ch	—	49	73		

### Notes:

- ① Repetitive rating; pulse width limited by max. junction temperature. ( See fig. 22 )
- ② N-Channel I<sub>SD</sub> ≤ 4.1A, di/dt ≤ 92A/μs, V<sub>DD</sub> ≤ V<sub>(BR)DSS</sub>, T<sub>J</sub> ≤ 150°C  
P-Channel I<sub>SD</sub> ≤ -2.9A, di/dt ≤ -77A/μs, V<sub>DD</sub> ≤ V<sub>(BR)DSS</sub>, T<sub>J</sub> ≤ 150°C
- ③ N-Channel Starting T<sub>J</sub> = 25°C, L = 12mH R<sub>G</sub> = 25Ω, I<sub>AS</sub> = 4.1A. (See Figure 12)  
P-Channel Starting T<sub>J</sub> = 25°C, L = 35mH R<sub>G</sub> = 25Ω, I<sub>AS</sub> = -2.9A.
- ④ Pulse width ≤ 300μs; duty cycle ≤ 2%.
- ⑤ Surface mounted on FR-4 board, t ≤ 10sec.

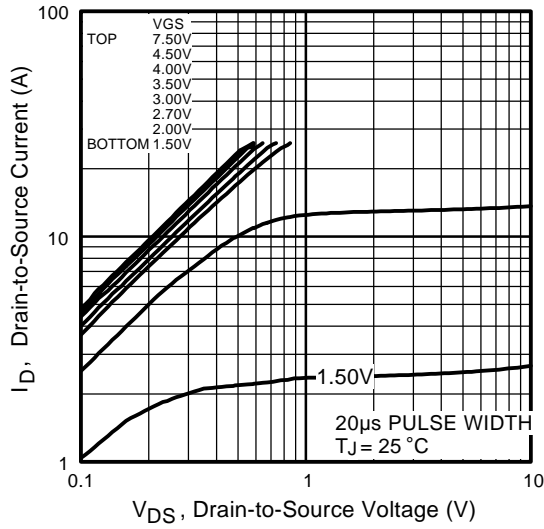

**Fig 1.** Typical Output Characteristics

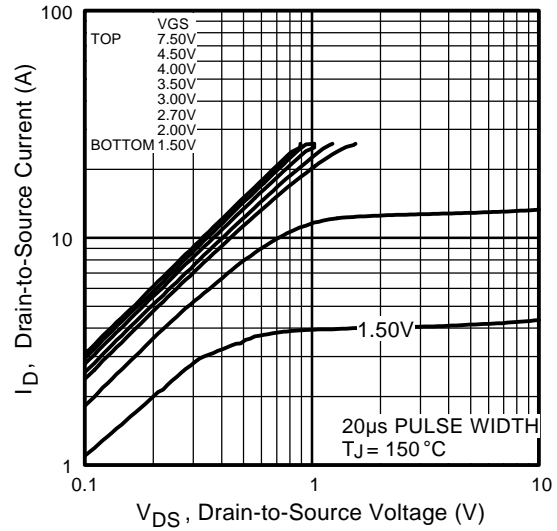

**Fig 2.** Typical Output Characteristics

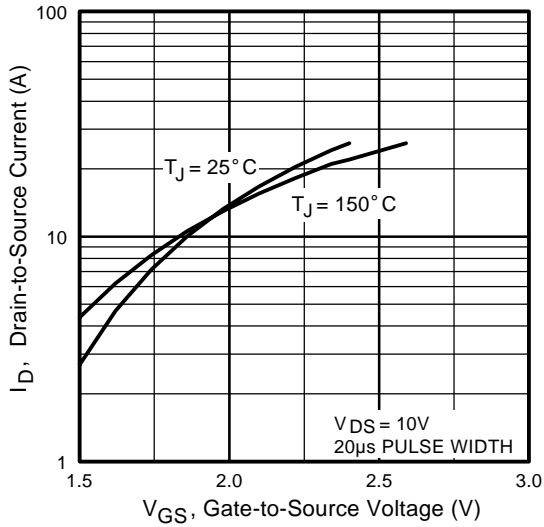

**Fig 3.** Typical Transfer Characteristics

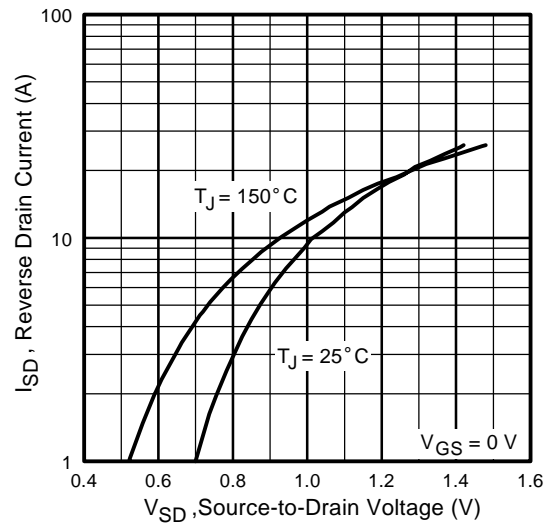

**Fig 4.** Typical Source-Drain Diode Forward Voltage

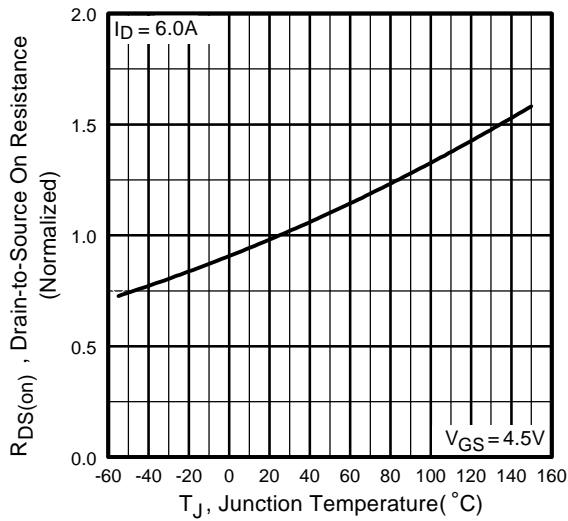

**Fig 5.** Normalized On-Resistance Vs. Temperature

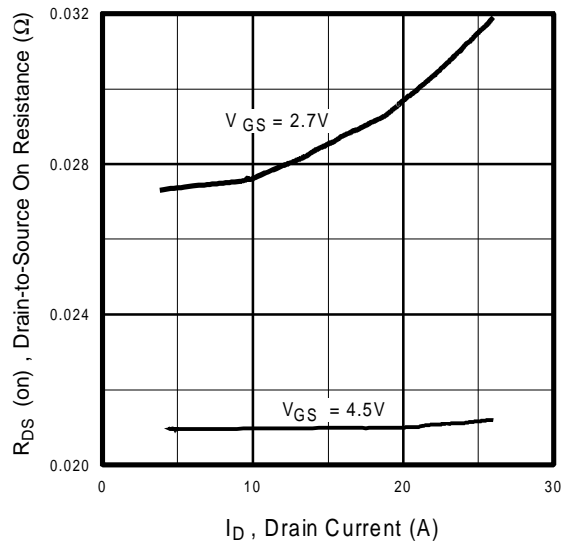

**Fig 6.** Typical On-Resistance Vs. Drain Current

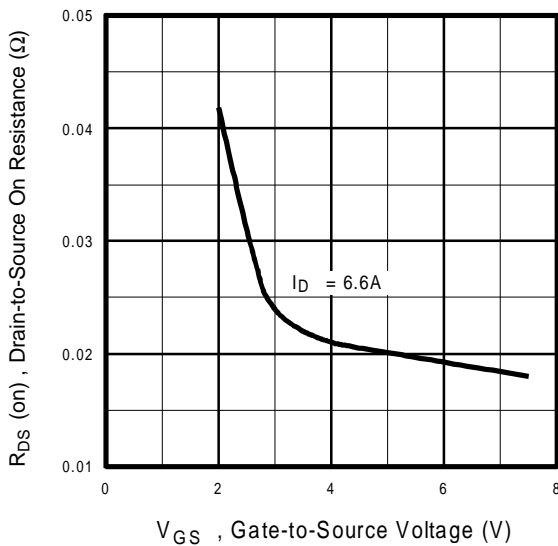

**Fig 7.** Typical On-Resistance Vs. Gate Voltage

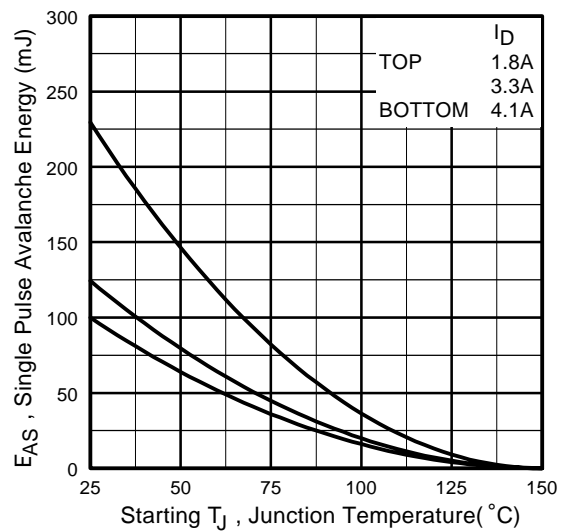

**Fig 8.** Maximum Avalanche Energy Vs. Drain Current

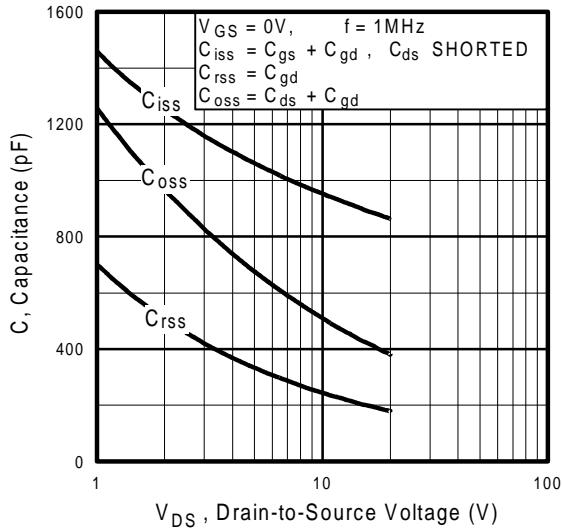

**Fig 9.** Typical Capacitance Vs. Drain-to-Source Voltage

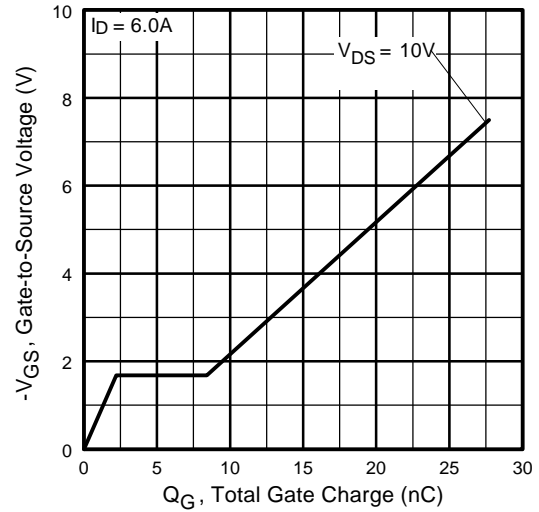

**Fig 10.** Typical Gate Charge Vs. Gate-to-Source Voltage

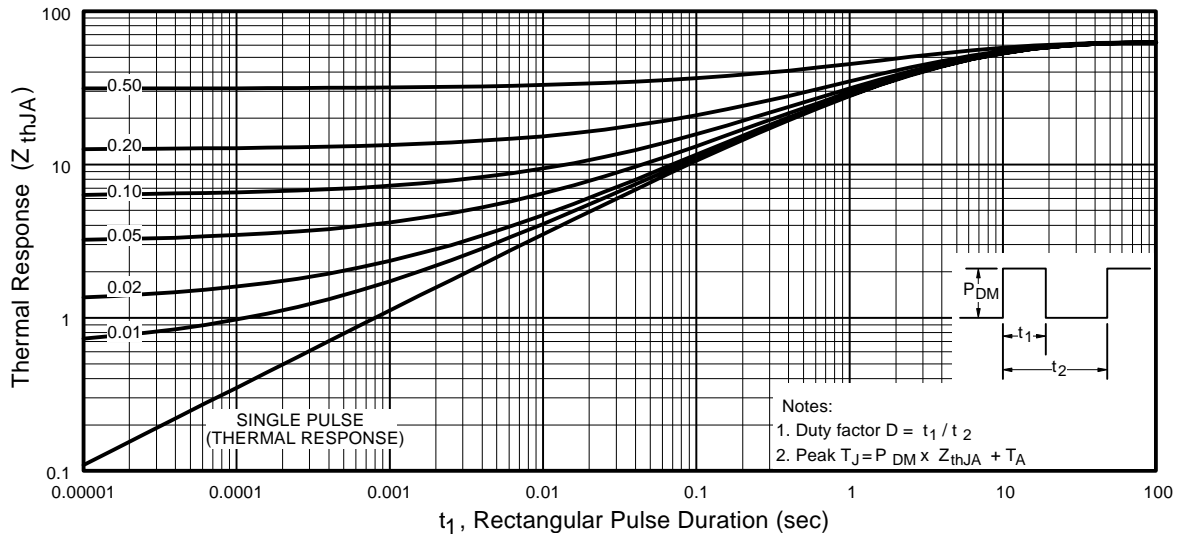

**Fig 11.** Maximum Effective Transient Thermal Impedance, Junction-to-Ambient

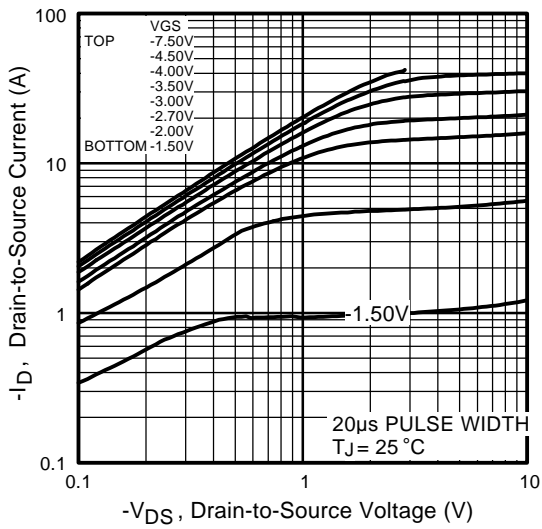

**Fig 12.** Typical Output Characteristics

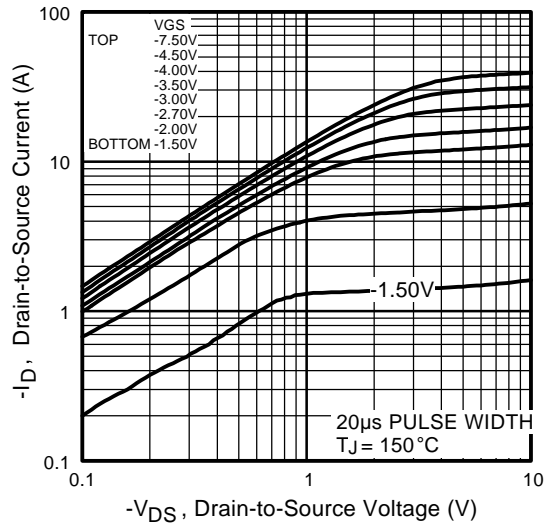

**Fig 13.** Typical Output Characteristics

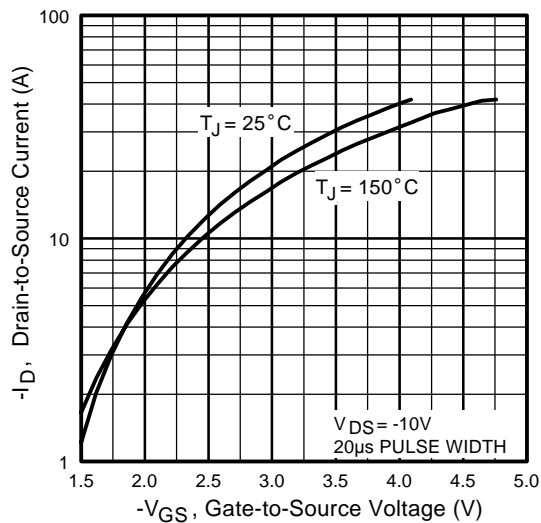

**Fig 14.** Typical Transfer Characteristics

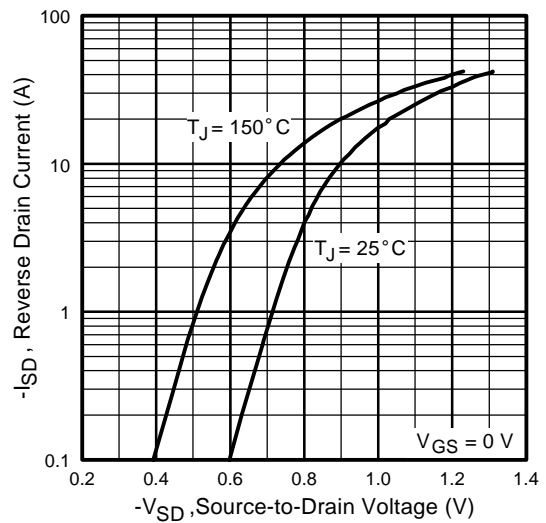

**Fig 15.** Typical Source-Drain Diode Forward Voltage

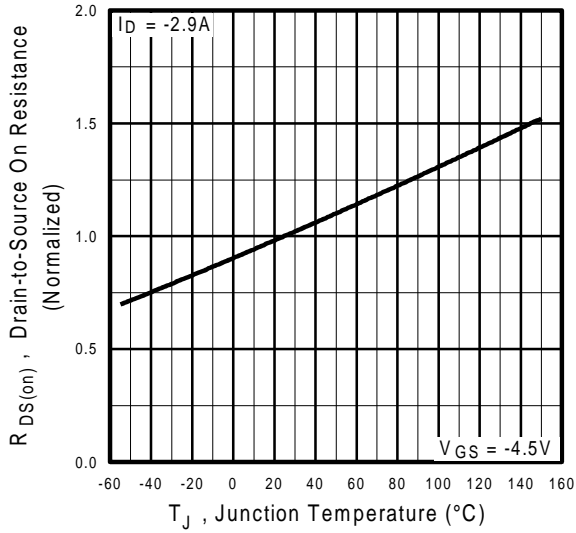

**Fig 16.** Normalized On-Resistance Vs. Temperature

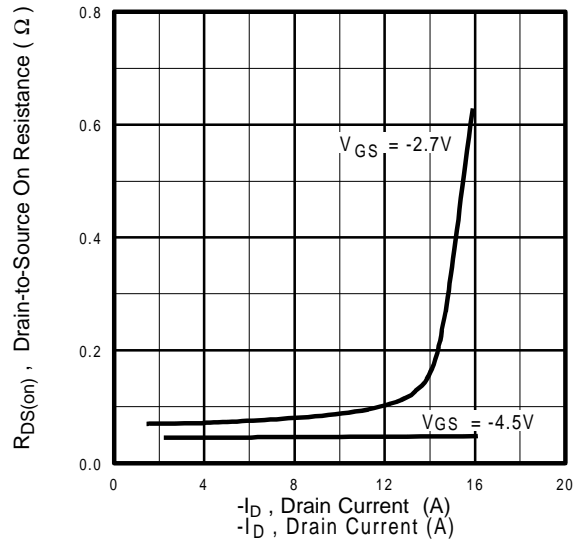

**Fig 17.** Typical On-Resistance Vs. Drain Current

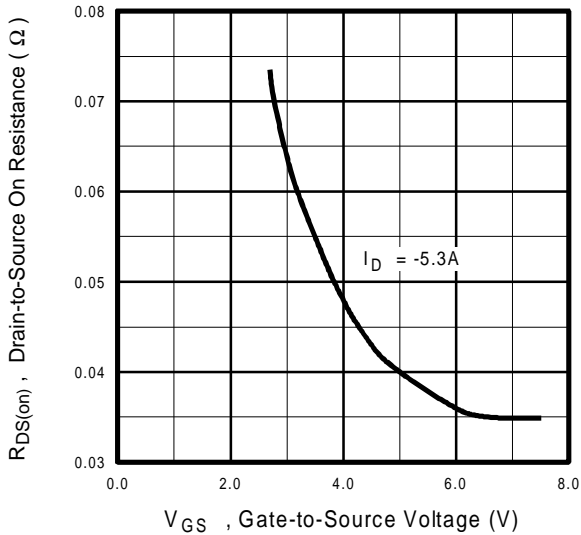

**Fig 18.** Typical On-Resistance Vs. Gate Voltage

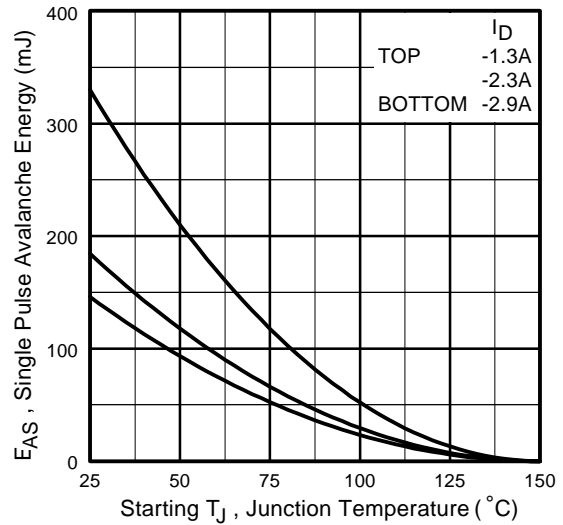

**Fig 19.** Maximum Avalanche Energy Vs. Drain Current

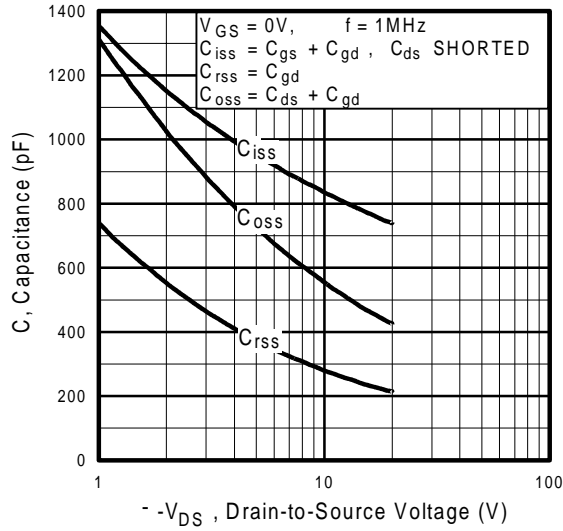

**Fig 20.** Typical Capacitance Vs. Drain-to-Source Voltage

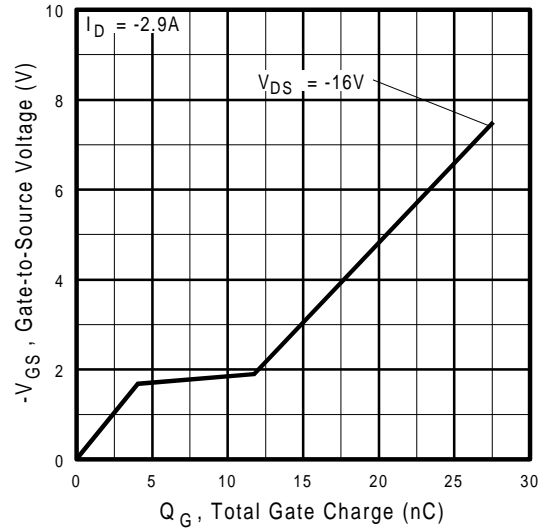

**Fig 21.** Typical Gate Charge Vs. Gate-to-Source Voltage

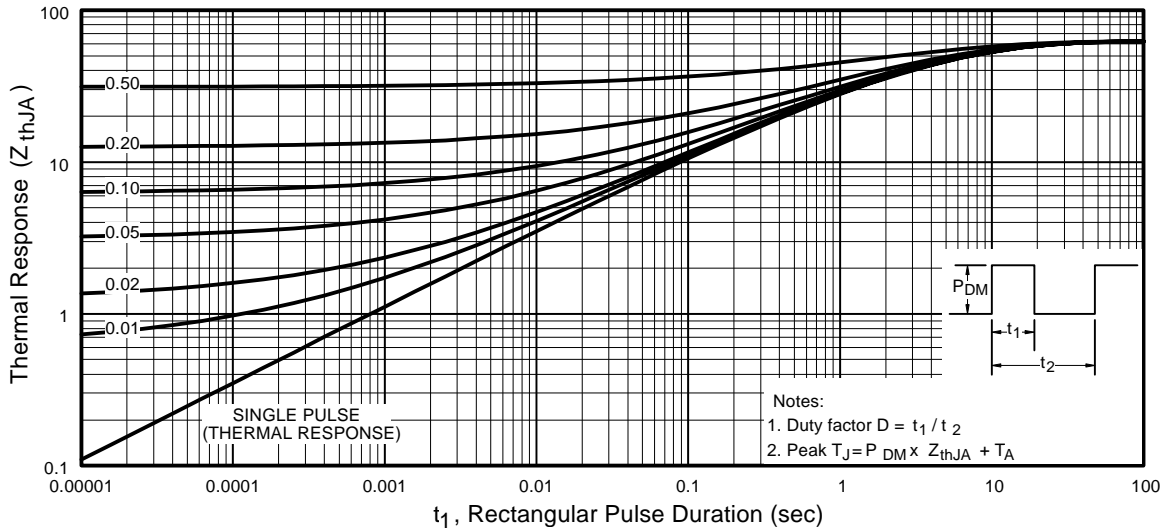

**Fig 22.** Maximum Effective Transient Thermal Impedance, Junction-to-Ambient



## Package Outline SO8 Outline

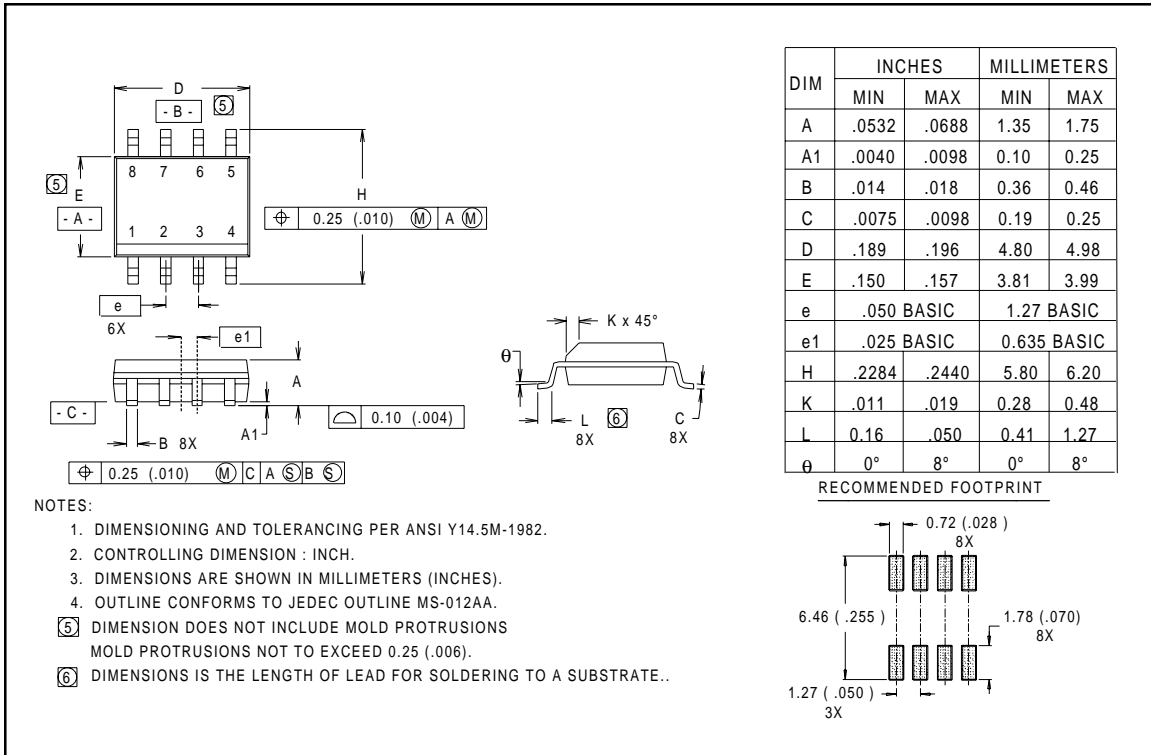

## Part Marking Information

### SO8

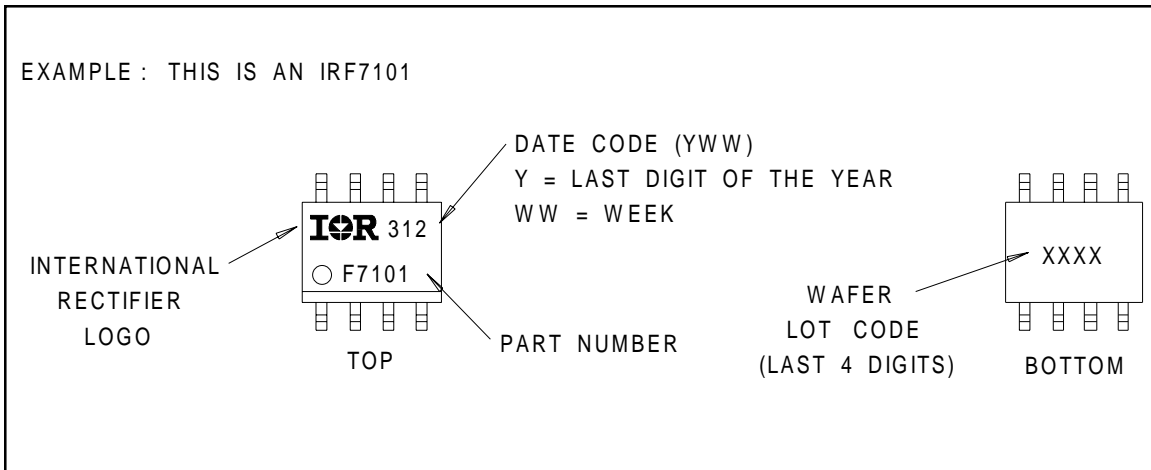

# IRF7317

International  
**IOR** Rectifier

## Tape & Reel Information

**S08**

Dimensions are shown in millimeters (inches)

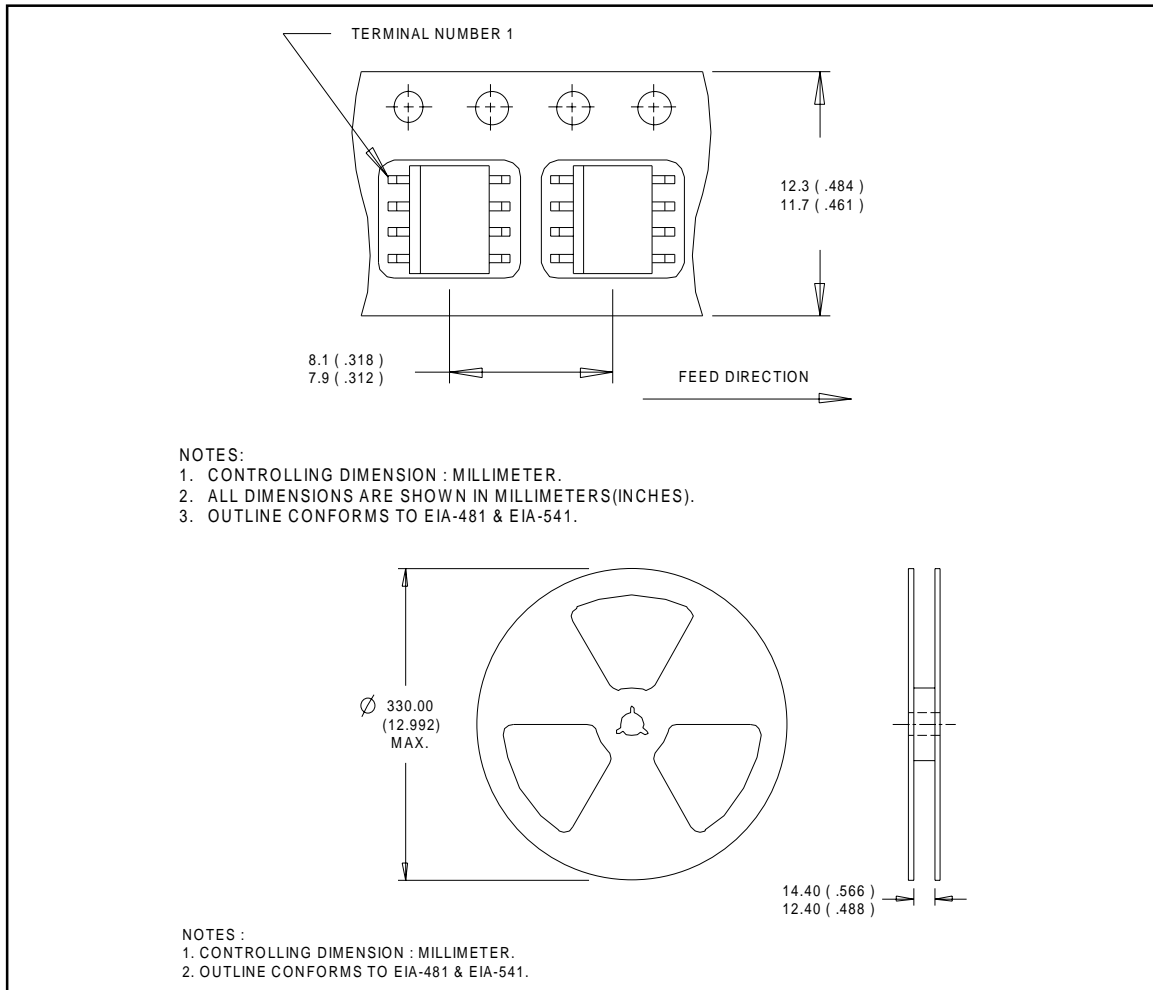

International  
**IOR** Rectifier

**WORLD HEADQUARTERS:** 233 Kansas St., El Segundo, California 90245, Tel: (310) 322 3331  
**EUROPEAN HEADQUARTERS:** Hurst Green, Oxted, Surrey RH8 9BB, UK Tel: ++ 44 1883 732020

**IR CANADA:** 7321 Victoria Park Ave., Suite 201, Markham, Ontario L3R 2Z8, Tel: (905) 475 1897

**IR GERMANY:** Saalburgstrasse 157, 61350 Bad Homburg Tel: ++ 49 6172 96590

**IR ITALY:** Via Liguria 49, 10071 Borgaro, Torino Tel: ++ 39 11 451 0111

**IR FAR EAST:** K&H Bldg., 2F, 30-4 Nishi-Ikebukuro 3-Chome, Toshima-Ku, Tokyo Japan 171 Tel: 81 3 3983 0086

**IR SOUTHEAST ASIA:** 315 Outram Road, #10-02 Tan Boon Liat Building, Singapore 0316 Tel: 65 221 8371

<http://www.irf.com/> Data and specifications subject to change without notice. 12/97