

## CURM101-G Thru. CURM107-G

Reverse Voltage: 50 - 1000 Volts

Forward Current: 1.0 Amp

RoHS Device

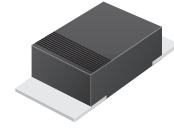

### Features

- Ideal for surface mount applications
- Easy pick and place
- Plastic package has Underwriters Lab. flammability classification 94V-0
- Exceeds environmental standard MIL-S-19500/228
- Low leakage current

### Mechanical data

- Case: Mini SMA/SOD-123 molded plastic
- Terminals: solderable per MIL-STD-750, method 2026
- Polarity: Indicated by cathode band
- Mounting position: Any
- Approx. Weight: 0.04 grams

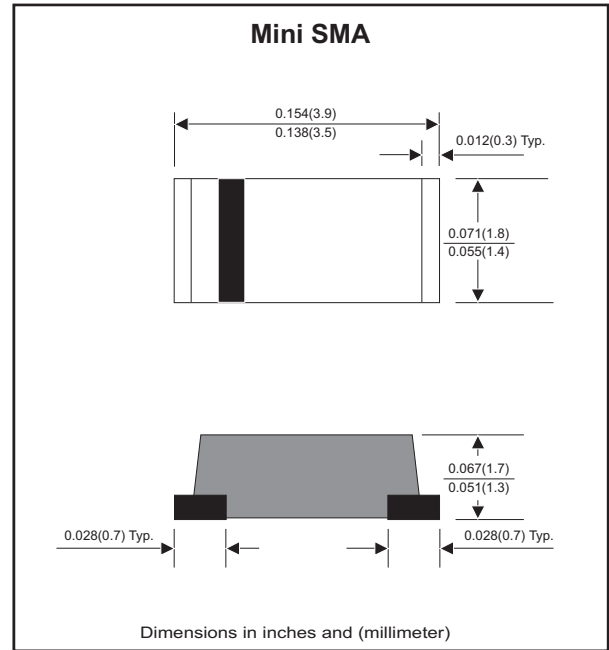

### Maximum Ratings and Electrical Characteristics

Parameter	Symbol	CURM 101-G	CURM 102-G	CURM 103-G	CURM 104-G	CURM 105-G	CURM 106-G	CURM 107-G	Unit
Repetitive Peak Reverse Voltage	V <sub>RRM</sub>	50	100	200	400	600	800	1000	V
Continuous reverse voltage	V <sub>R</sub>	50	100	200	400	600	800	1000	V
RMS Voltage	V <sub>RMS</sub>	35	70	140	280	420	560	700	V
Max. Forward Surge Current 8.3ms single half sine-wave superimposed on rate load ( JEDEC method )	I <sub>FSM</sub>	30							A
Max. Forward rectified Current	I <sub>o</sub>	1.0							A
Max. Forward voltage at I <sub>F</sub> =1.0A	V <sub>F</sub>	1.0		1.3		1.7		V	
Max. Reverse recovery time (Note 1)	T <sub>rr</sub>	50				75			nS
Max. Reverse Current	V <sub>R</sub> =V <sub>RRM</sub> , T <sub>J</sub> =25°C	5.0							μA
	V <sub>R</sub> =V <sub>RRM</sub> , T <sub>J</sub> =100°C	150							
TYP. Thermal Resistance (Note 1)	R <sub>θJA</sub>	42							°C/W
TYP. Diode Junction Capacitance (F=1MHz and applied 4V DC reverse voltage)	C <sub>J</sub>	20							pF
Operating Junction Temperature	T <sub>J</sub>	-55 to +150							°C
Storage Temperature	T <sub>STG</sub>	-65 to +175							°C

Note 1: Reverse recovery time test Condition, I<sub>F</sub>=0.5A, I<sub>R</sub>=1.0A, I<sub>RR</sub>=0.25A

## Rating and Characteristic Curves (CURM101-G Thru CURM107-G)

Fig.1 - Typical Forward Characteristics

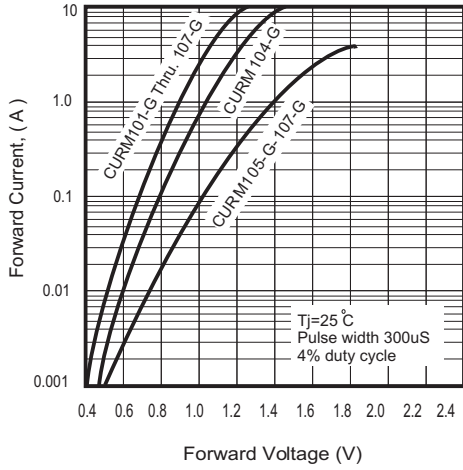

Fig. 2 - Typical Forward Current Derating Curve

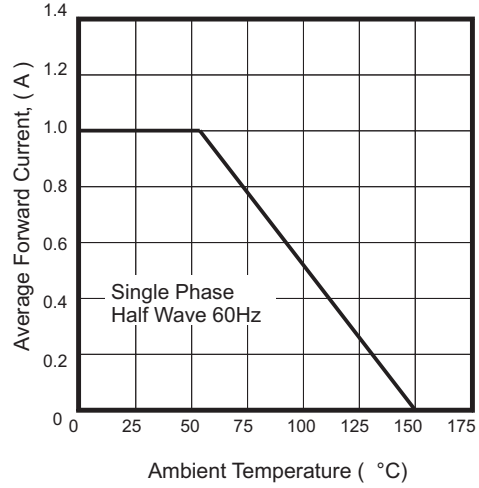
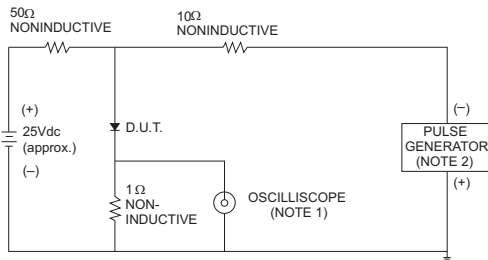

Fig. 3 - Test Circuit Diagram and Reverse Recovery Time Characteristics



NOTES: 1. Rise Time= 7ns max., Input Impedance= 1 megohm.22pF.  
2. Rise Time= 10ns max., Source Impedance= 50 ohms.

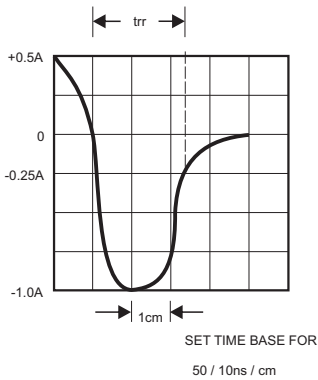

Fig. 4 - Maximum Non-Repetitive Forward Surge Current

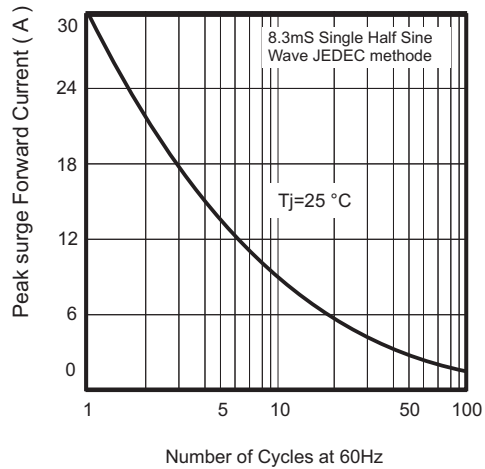
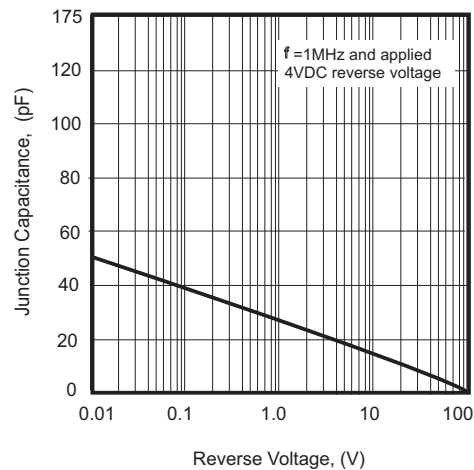
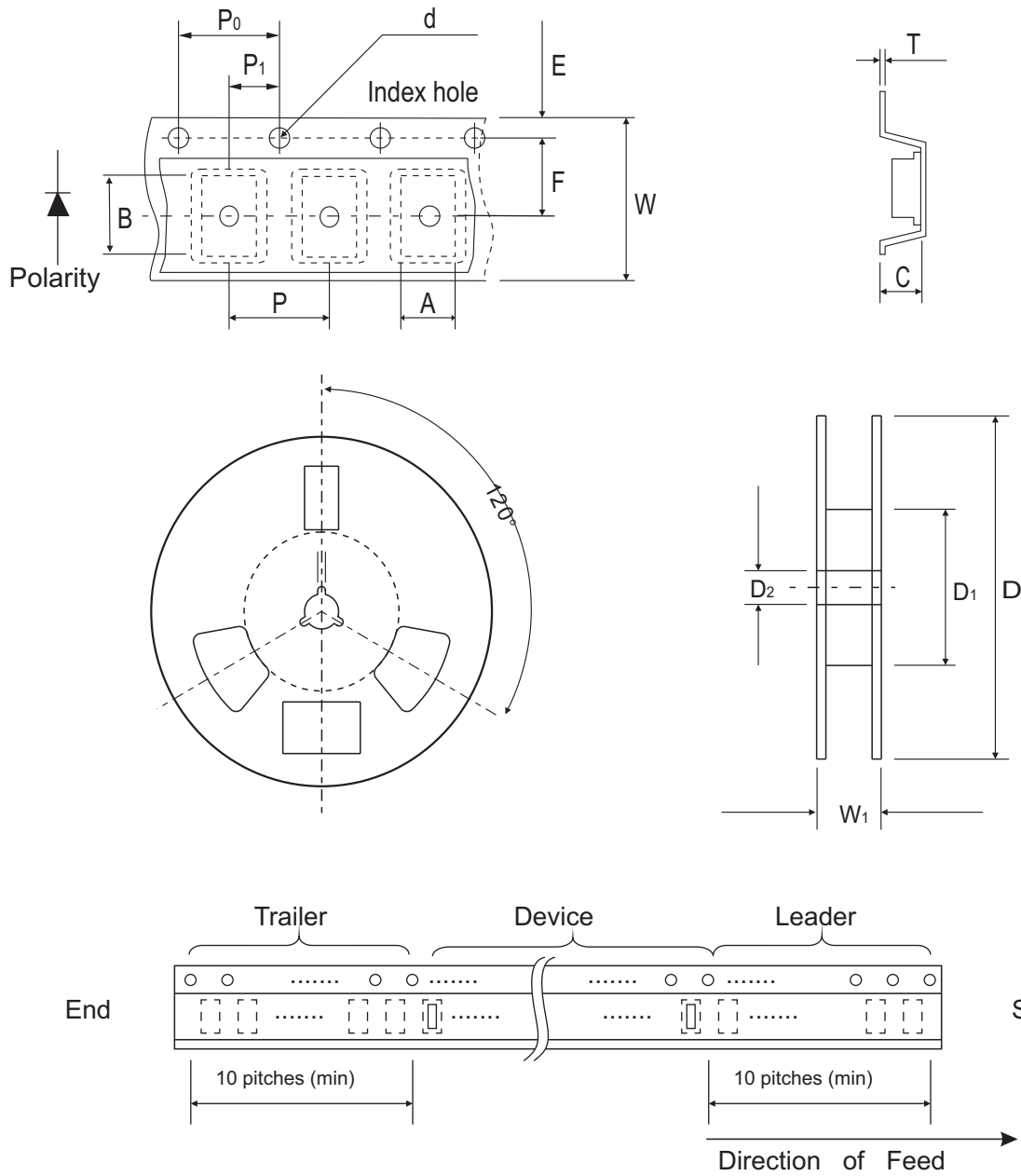

Fig.5 - Typical Junction Capacitance



## Reel Taping Specification



Mini-SMA/SOD-123	SYMBOL	A	B	C	d	D	D1	D2
	(mm)	1.90 ± 0.10	3.90 ± 0.10	1.68 ± 0.10	1.50 ± 0.10	178 ± 2.00	62.0 MIN.	13.0 ± 0.50
	(inch)	0.075 ± 0.04	0.154 ± 0.04	0.066 ± 0.04	0.059 ± 0.004	7.00 ± 0.079	2.440 MIN.	0.512 ± 0.020

Mini-SMA/SOD-123	SYMBOL	E	F	P	P0	P1	T	W	W1
	(mm)	1.75 ± 0.10	3.50 ± 0.10	4.00 ± 0.10	4.00 ± 0.10	2.00 ± 0.10	0.23 ± 0.10	8.00 ± 0.30	11.40 ± 1.0
	(inch)	0.069 ± 0.004	0.138 ± 0.004	0.157 ± 0.004	0.157 ± 0.004	0.079 ± 0.004	0.009 ± 0.004	0.315 ± 0.012	0.449 ± 0.004

## Marking Code

Part Number	Marking Code
CURM101-G	H1
CURM102-G	H2
CURM103-G	H3
CURM104-G	H4
CURM105-G	H5
CURM106-G	H6
CURM107-G	H7



XX = Product type marking code

## Suggested PAD Layout

SIZE	Mini-SMA/SOD-123	
	(mm)	(inch)
A	3.30	0.130
B	1.40	0.055
C	1.90	0.075
D	4.70	0.185
E	1.90	0.075

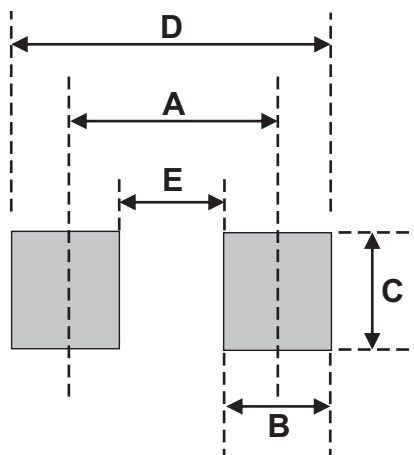

## Standard Packaging

Case Type	Qty per Reel	Reel Size
	(Pcs)	(inch)
Mini-SMA/SOD-123	2,500	7