

FEATURES

- Gain of 5 Stable
- 150MHz Gain Bandwidth
- 400V/ μ s Slew Rate
- 20V/mV DC Gain, $R_L = 500\Omega$
- 1mV Maximum Input Offset Voltage
- ± 12 V Minimum Output Swing into 500Ω
- Wide Supply Range: ± 2.5 V to ± 15 V
- 7mA Supply Current
- 90ns Settling Time to 0.1%, 10V Step
- Drives All Capacitive Loads

APPLICATIONS

- Wideband Amplifiers
- Buffers
- Active Filters
- Video and RF Amplification
- Cable Drivers
- Data Acquisition Systems

DESCRIPTION

The LT1225 is a very high speed operational amplifier with excellent DC performance. The LT1225 features reduced input offset voltage and higher DC gain than devices with comparable bandwidth and slew rate. The circuit is a single gain stage with outstanding settling characteristics. The fast settling time makes the circuit an ideal choice for data acquisition systems. The output is capable of driving a 500Ω load to ± 12 V with ± 15 V supplies and a 150Ω load to ± 3 V on ± 5 V supplies. The circuit is also capable of driving large capacitive loads which makes it useful in buffer or cable driver applications.

The LT1225 is a member of a family of fast, high performance amplifiers that employ Linear Technology Corporation's advanced bipolar complementary processing.

TYPICAL APPLICATION

20MHz, $A_V = 50$ Instrumentation Amplifier

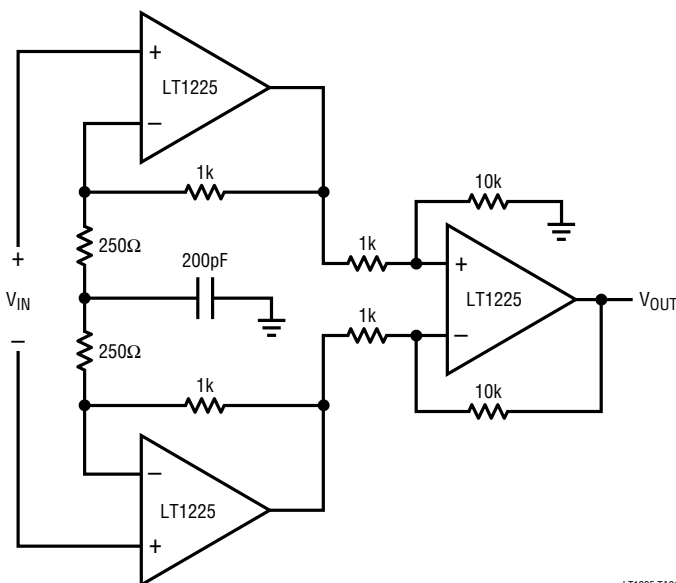

LT1225 TA01

Gain of 5 Pulse Response

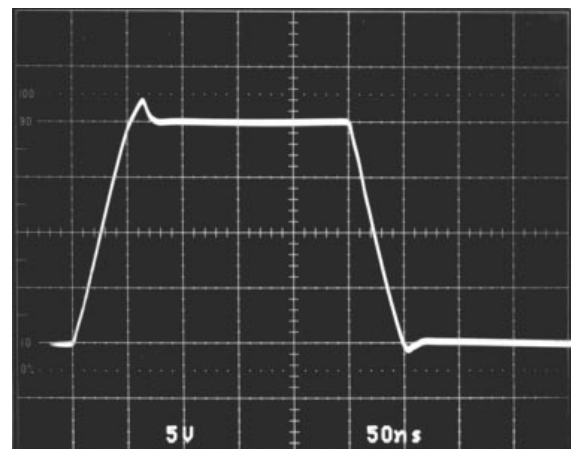

LT1225 TA02

ABSOLUTE MAXIMUM RATINGS

Total Supply Voltage (V^+ to V^-)	36V
Differential Input Voltage	$\pm 6V$
Input Voltage	$\pm V_S$
Output Short Circuit Duration (Note 1)	Indefinite
Operating Temperature Range	
LT1225C	0°C to 70°C
Maximum Junction Temperature	
Plastic Package	150°C
Storage Temperature Range	- 65°C to 150°C
Lead Temperature (Soldering, 10 sec.)	300°C

PACKAGE/ORDER INFORMATION

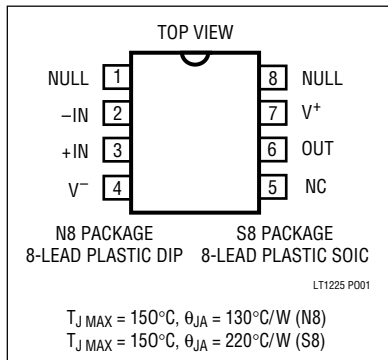
	ORDER PART NUMBER
	LT1225CN8 LT1225CS8
	S8 PART MARKING
	1225

ELECTRICAL CHARACTERISTICS $V_S = \pm 15V$, $T_A = 25^\circ C$, $V_{CM} = 0V$ unless otherwise noted.

SYMBOL	PARAMETER	CONDITIONS	MIN	TYP	MAX	UNITS
V_{OS}	Input Offset Voltage	(Note 2)		0.5	1.0	mV
I_{OS}	Input Offset Current			100	400	nA
I_B	Input Bias Current			4	8	μA
e_n	Input Noise Voltage	$f = 10kHz$		7.5		nV/\sqrt{Hz}
i_n	Input Noise Current	$f = 10kHz$		1.5		pA/\sqrt{Hz}
R_{IN}	Input Resistance	$V_{CM} = \pm 12V$ Differential	24	40 70		M Ω k Ω
C_{IN}	Input Capacitance			2		pF
	Input Voltage Range +		12	14		V
	Input Voltage Range -			-13	-12	V
CMRR	Common-Mode Rejection Ratio	$V_{CM} = \pm 12V$	94	115		dB
PSRR	Power Supply Rejection Ratio	$V_S = \pm 5V$ to $\pm 15V$	86	95		dB
A_{VOL}	Large Signal Voltage Gain	$V_{OUT} = \pm 10V$, $R_L = 500\Omega$	12.5	20		V/mV
V_{OUT}	Output Swing	$R_L = 500\Omega$	± 12.0	± 13.3		V
I_{OUT}	Output Current	$V_{OUT} = \pm 12V$	24	40		mA
SR	Slew Rate	(Note 3)	250	400		V/ μs
	Full Power Bandwidth	10V Peak, (Note 4)		6.4		MHz
GBW	Gain Bandwidth	$f = 1MHz$		150		MHz
t_r , t_f	Rise Time, Fall Time	$A_{VCL} = 5$, 10% to 90%, 0.1V		7		ns
	Overshoot	$A_{VCL} = 5$, 0.1V		20		%
	Propagation Delay	50% V_{IN} to 50% V_{OUT}		7		ns
t_s	Settling Time	10V Step, 0.1%, $A_V = -5$		90		ns
	Differential Gain	$f = 3.58MHz$, $A_V = 5$, $R_L = 150\Omega$		1.0		%
	Differential Phase	$f = 3.58MHz$, $A_V = 5$, $R_L = 150\Omega$		1.7		Deg
R_O	Output Resistance	$A_{VCL} = 5$, $f = 1MHz$		4.5		Ω
I_S	Supply Current			7	9	mA

ELECTRICAL CHARACTERISTICS $V_S = \pm 5V$, $T_A = 25^\circ C$, $V_{CM} = 0V$ unless otherwise noted.

SYMBOL	PARAMETER	CONDITIONS	MIN	TYP	MAX	UNITS
V_{OS}	Input Offset Voltage	(Note 2)		1.0	2.0	mV
I_{OS}	Input Offset Current			100	400	nA
I_B	Input Bias Current			4	8	μA
	Input Voltage Range +		2.5	4		V
	Input Voltage Range -			-3	-2.5	V
CMRR	Common-Mode Rejection Ratio	$V_{CM} = \pm 2.5V$	94	115		dB
A_{VOL}	Large-Signal Voltage Gain	$V_{OUT} = \pm 2.5V$, $R_L = 500\Omega$ $V_{OUT} = \pm 2.5V$, $R_L = 150\Omega$	10	15 13		V/mV V/mV
V_{OUT}	Output Voltage	$R_L = 500\Omega$ $R_L = 150\Omega$	± 3.0 ± 3.0	± 3.7 ± 3.3		V V
I_{OUT}	Output Current	$V_{OUT} = \pm 3V$	20	40		mA
SR	Slew Rate	(Note 3)		250		V/ μs
	Full Power Bandwidth	3V Peak, (Note 4)		13.3		MHz
GBW	Gain Bandwidth	$f = 1MHz$		100		MHz
t_r , t_f	Rise Time, Fall Time	$A_{VCL} = 5$, 10% to 90%, 0.1V		9		ns
	Overshoot	$A_{VCL} = 5$, 0.1V		10		%
	Propagation Delay	50% V_{IN} to 50% V_{OUT}		9		ns
t_s	Settling Time	-2.5V to 2.5V, 0.1%, $A_V = -4$		70		ns
I_S	Supply Current			7	9	mA

ELECTRICAL CHARACTERISTICS $0^\circ C \leq T_A \leq 70^\circ C$, $V_{CM} = 0V$ unless otherwise noted.

SYMBOL	PARAMETER	CONDITIONS	MIN	TYP	MAX	UNITS
V_{OS}	Input Offset Voltage	$V_S = \pm 15V$, (Note 2) $V_S = \pm 5V$, (Note 2)		0.5 1.0	1.5 2.5	mV mV
	Input V_{OS} Drift			10		$\mu V/^\circ C$
I_{OS}	Input Offset Current	$V_S = \pm 15V$ and $V_S = \pm 5V$		100	600	nA
I_B	Input Bias Current	$V_S = \pm 15V$ and $V_S = \pm 5V$		4	9	μA
CMRR	Common-Mode Rejection Ratio	$V_S = \pm 15V$, $V_{CM} = \pm 12V$ and $V_S = \pm 5V$, $V_{CM} = \pm 2.5V$	93	115		dB
PSRR	Power Supply Rejection Ratio	$V_S = \pm 5V$ to $\pm 15V$	85	95		dB
A_{VOL}	Large Signal Voltage Gain	$V_S = \pm 15V$, $V_{OUT} = \pm 10V$, $R_L = 500\Omega$ $V_S = \pm 5V$, $V_{OUT} = \pm 2.5V$, $R_L = 500\Omega$	10 8	12.5 10		V/mV V/mV
V_{OUT}	Output Swing	$V_S = \pm 15V$, $R_L = 500\Omega$ $V_S = \pm 5V$, $R_L = 500\Omega$ or 150Ω	± 12.0 ± 3.0	± 13.3 ± 3.3		V V
I_{OUT}	Output Current	$V_S = \pm 15V$, $V_{OUT} = \pm 12V$ $V_S = \pm 5V$, $V_{OUT} = \pm 3V$	24 20	40 40		mA mA
SR	Slew Rate	$V_S = \pm 15V$, (Note 3)	250	400		V/ μs
I_S	Supply Current	$V_S = \pm 15V$ and $V_S = \pm 5V$		7	10.5	mA

Note 1: A heat sink may be required to keep the junction temperature below absolute maximum when the output is shorted indefinitely.

Note 2: Input offset voltage is tested with automated test equipment in <1 second.

Note 3: Slew rate is measured between $\pm 10V$ on an output swing of $\pm 12V$ on $\pm 15V$ supplies, and $\pm 2V$ on an output swing of $\pm 3.5V$ on $\pm 5V$ supplies.

Note 4: Full power bandwidth is calculated from the slew rate measurement: $FPBW = SR/2\pi V_p$.

TYPICAL PERFORMANCE CHARACTERISTICS

Input Common-Mode Range vs Supply Voltage

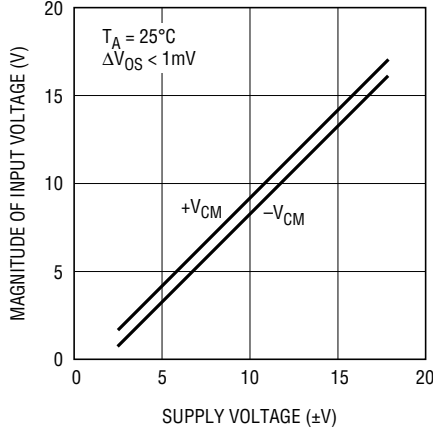

Supply Current vs Supply Voltage

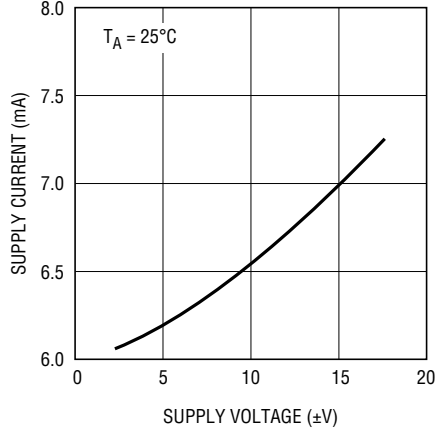

Output Voltage Swing vs Supply Voltage

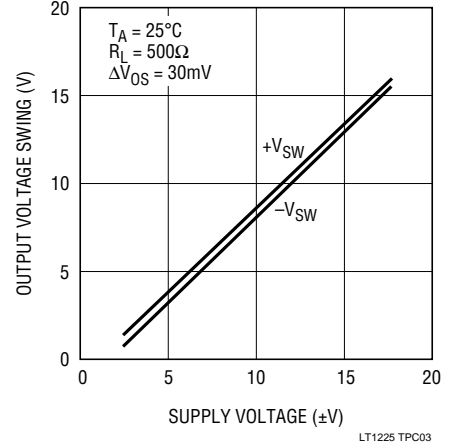

Output Voltage Swing vs Resistive Load

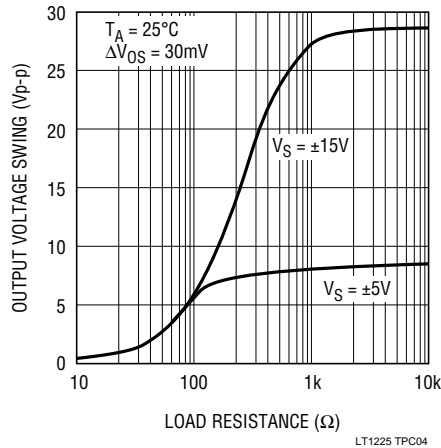

Input Bias Current vs Input Common-Mode Voltage

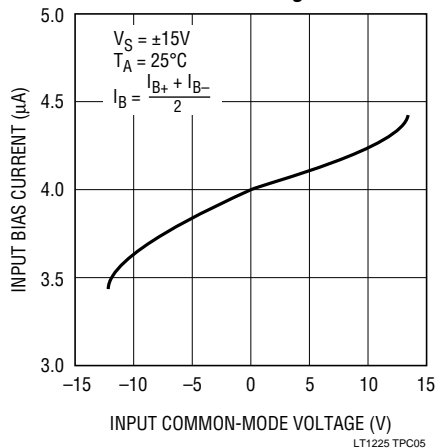

Open-Loop Gain vs Resistive Load

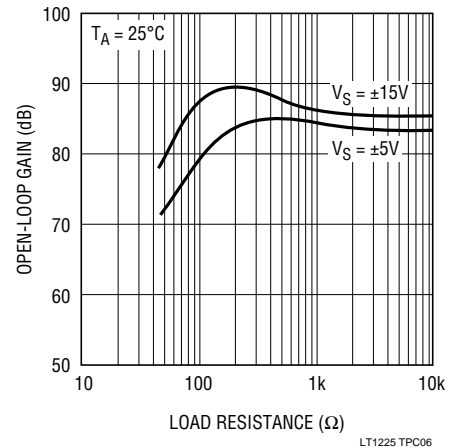

Supply Current vs Temperature

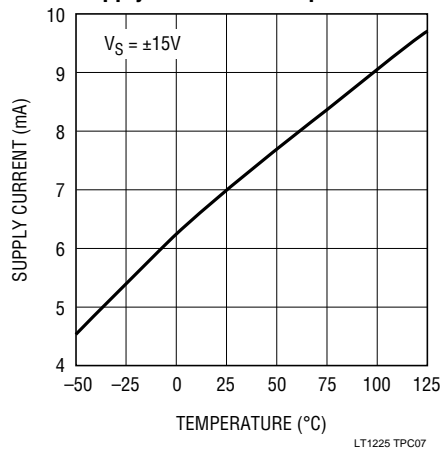

Input Bias Current vs Temperature

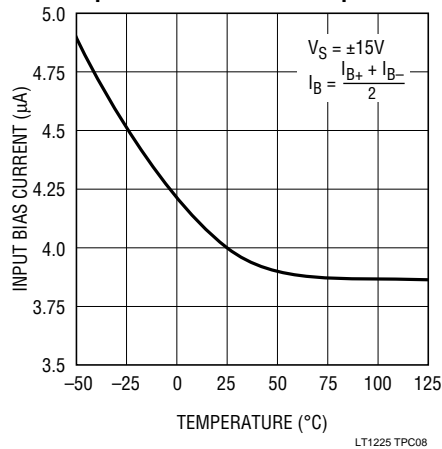

Output Short-Circuit Current vs Temperature

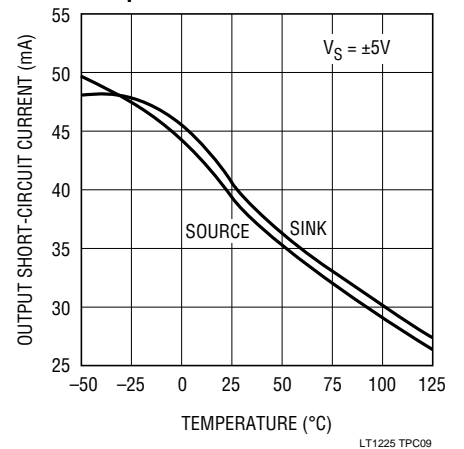

TYPICAL PERFORMANCE CHARACTERISTICS

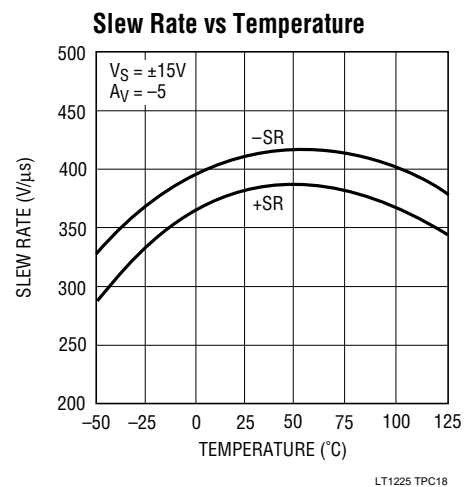
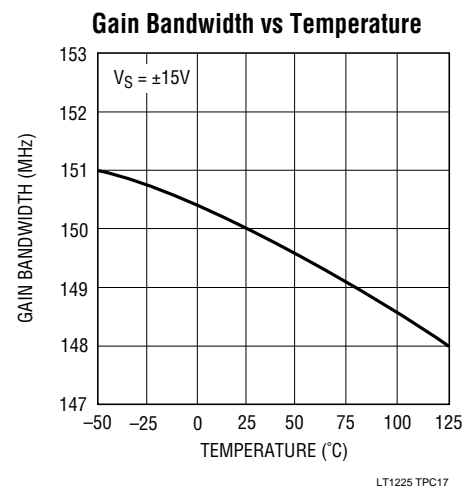
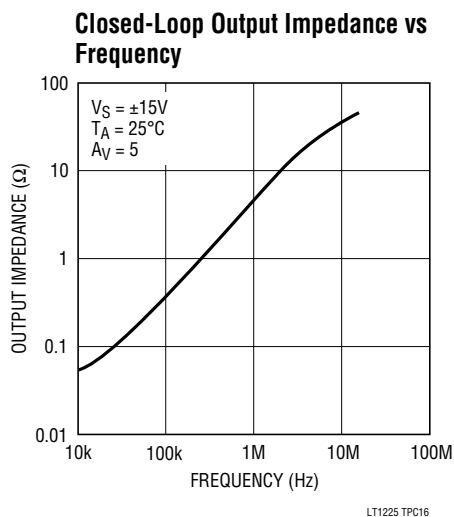
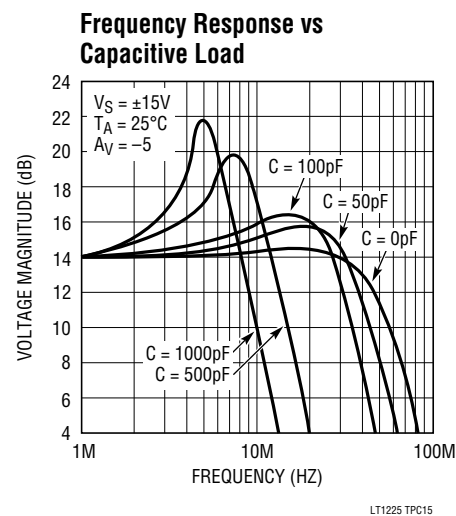
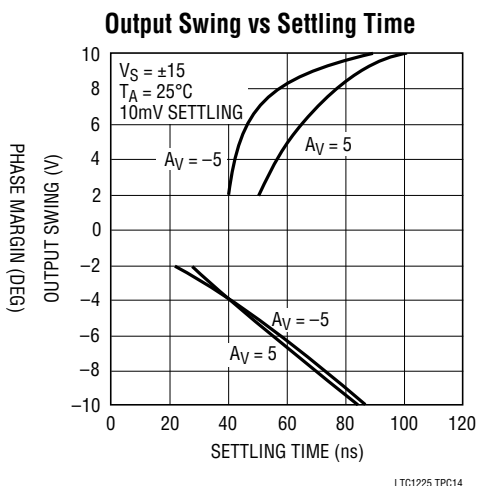
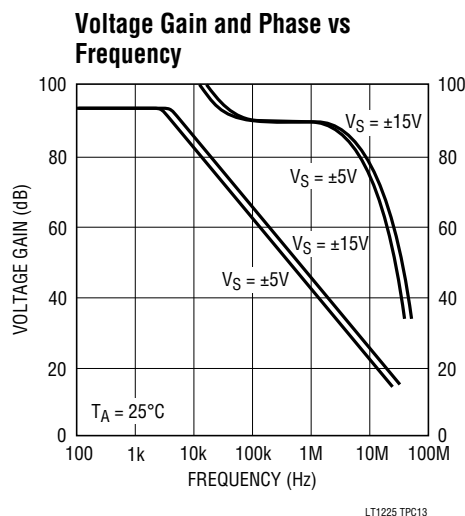
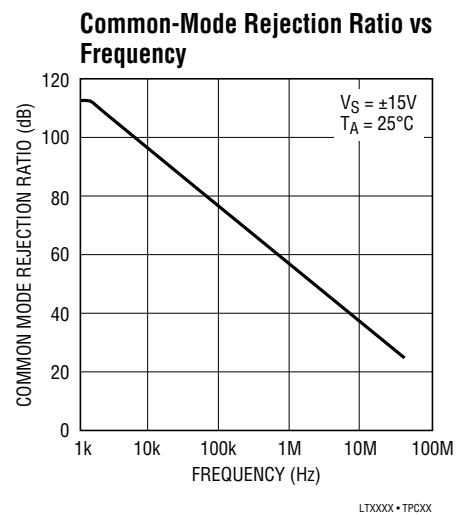
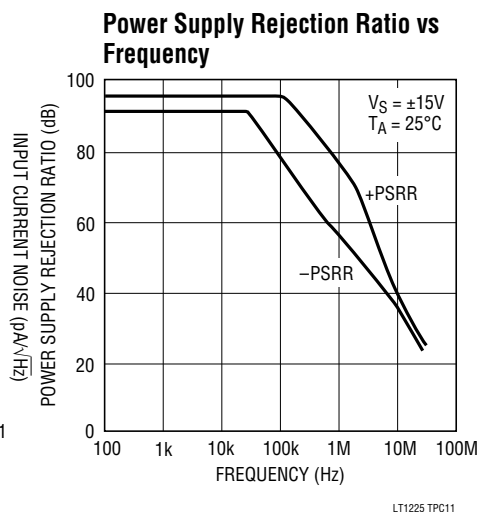
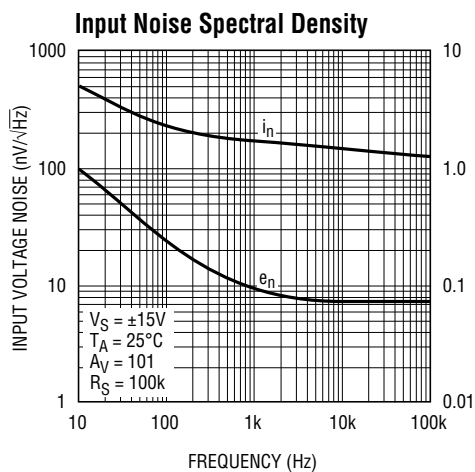

APPLICATIONS INFORMATION

The LT1225 may be inserted directly into HA2541, HA2544, AD847, EL2020 and LM6361 applications, provided that the amplifier configuration is a noise gain of 5 or greater, and the nulling circuitry is removed. The suggested nulling circuit for the LT1225 is shown below.

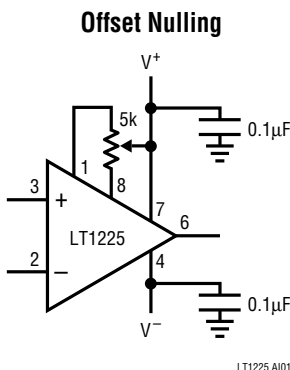

Layout and Passive Components

As with any high speed operational amplifier, care must be taken in board layout in order to obtain maximum performance. Key layout issues include: use of a ground plane, minimization of stray capacitance at the input pins, short lead lengths, RF-quality bypass capacitors located close to the device (typically 0.01µF to 0.1µF), and use of low ESR bypass capacitors for high drive current applications (typically 1µF to 10µF tantalum). Sockets should be avoided when maximum frequency performance is required, although low profile sockets can provide reasonable performance up to 50MHz. For more details see Design Note 50. Feedback resistor values greater than 5k are not recommended because a pole is formed with the input capacitance which can cause peaking. If feedback resistors greater than 5k are used, a parallel capacitor of 5pF to 10pF should be used to cancel the input pole and optimize dynamic performance.

Transient Response

The LT1225 gain-bandwidth is 150MHz when measured at 1MHz. The actual frequency response in gain of 5 is considerably higher than 30MHz due to peaking caused by a second pole beyond the gain of 5 crossover point. This is reflected in the small-signal transient response. Higher noise gain configurations exhibit less overshoot as seen in the inverting gain of 5 response.

Small Signal, $A_V = 5$

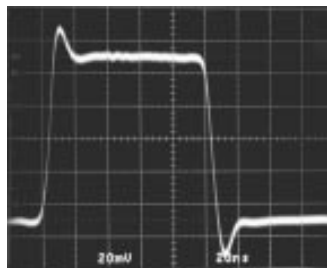

Small Signal, $A_V = -5$

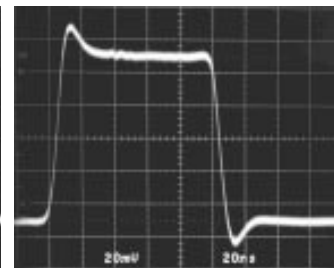

LT1225 A102

The large-signal response in both inverting and noninverting gain shows symmetrical slewing characteristics. Normally the noninverting response has a much faster rising edge than falling edge due to the rapid change in input common-mode voltage which affects the tail current of the input differential pair. Slew enhancement circuitry has been added to the LT1225 so that the noninverting slew rate response is balanced.

Large Signal, $A_V = 5$

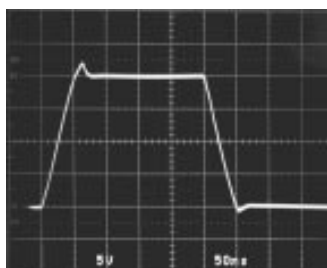

Large Signal, $A_V = -5$

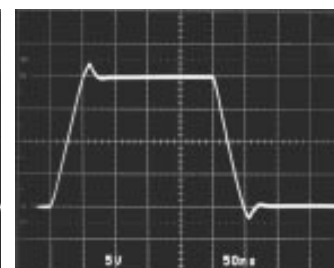

LT1225 A103

Input Considerations

Resistors in series with the inputs are recommended for the LT1225 in applications where the differential input voltage exceeds $\pm 6V$ continuously or on a transient basis. An example would be in noninverting configurations with high input slew rates or when driving heavy capacitive loads. The use of balanced source resistance at each input is recommended for applications where DC accuracy must be maximized.

Capacitive Loading

The LT1225 is stable with all capacitive loads. This is accomplished by sensing the load induced output pole and adding compensation at the amplifier gain node. As the capacitive load increases, both the bandwidth and phase margin decrease so there will be peaking in the frequency

APPLICATIONS INFORMATION

domain and in the transient response. The photo of the small-signal response with 1000pF load shows 50% peaking. The large-signal response with a 10,000pF load shows the output slew rate being limited by the short-circuit current.

$A_V = -5, C_L = 1000\text{pF}$

$A_V = 5, C_L = 10,000\text{pF}$

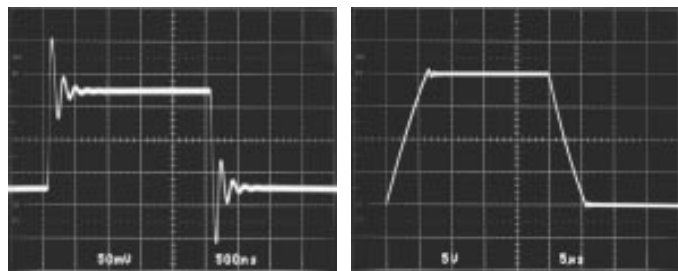

LT1225 A104

The LT1225 can drive coaxial cable directly, but for best pulse fidelity the cable should be doubly terminated with a resistor in series with the output.

Compensation

The LT1225 has a typical gain-bandwidth product of 150MHz which allows it to have wide bandwidth in high gain configurations (i.e., in a gain of 10 it will have a bandwidth of about 15MHz). The amplifier is stable in a noise gain of 5 so the ratio of the output signal to the inverting input must be 1/5 or less. Straightforward gain configurations of 5 or -4 are stable, but there are a few configurations that allow the amplifier to be stable for lower signal gains (the noise gain, however, remains 5 or more). One example is the summing amplifier shown in the typical applications section below. Each input signal has a gain of $-R_F/R_{IN}$ to the output, but it is easily seen that this configuration is equivalent to a gain of -4 as far as the amplifier is concerned. Lag compensation can also be used to give a low frequency gain less than 5 with a high frequency gain of 5 or greater. The example below has a DC gain of one, but an AC gain of 5. The break frequency of the RC combination across the amplifier inputs should be approximately a factor of 10 less than the gain bandwidth of the amplifier divided by the high frequency gain (in this case 1/10 of 150MHz/5 or 3MHz).

TYPICAL APPLICATIONS

Lag Compensation

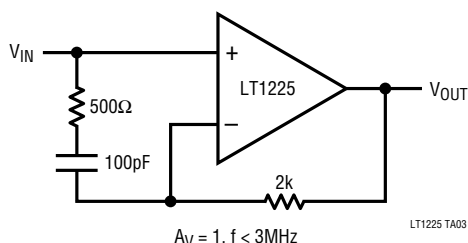

Cable Driving

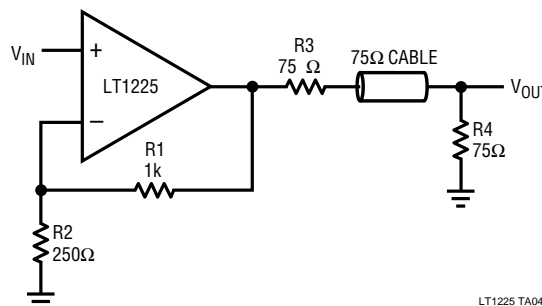

Wein Bridge Oscillator

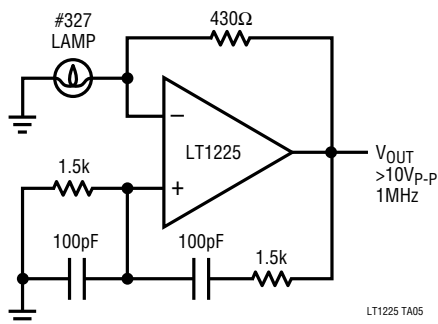

Summing Amplifier

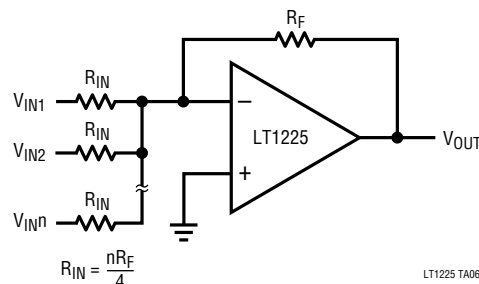

SIMPLIFIED SCHEMATIC

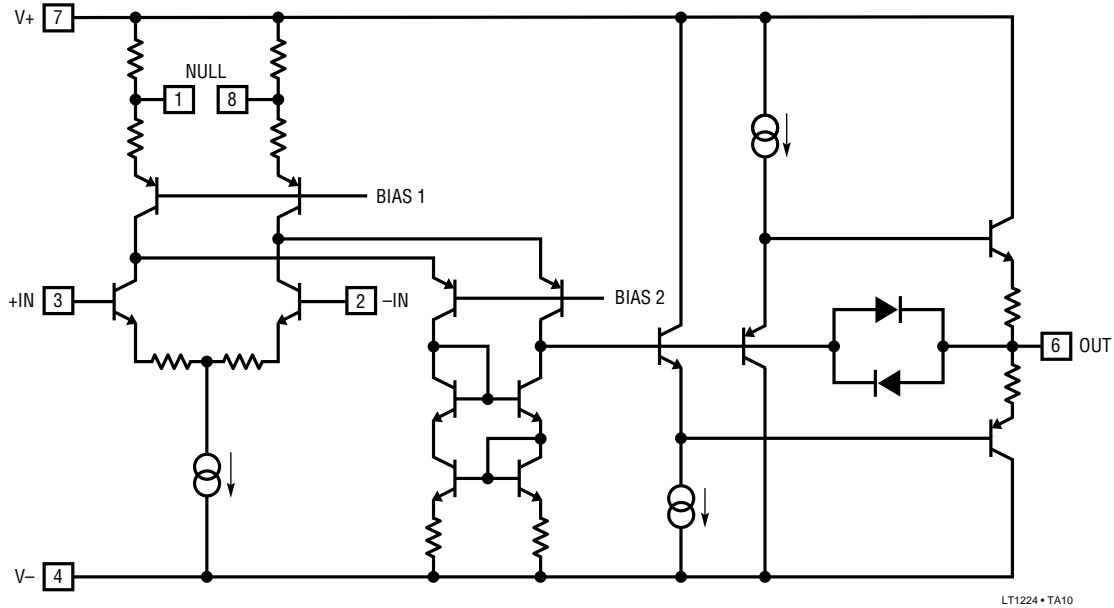

PACKAGE DESCRIPTION Dimensions in inches (millimeters) unless otherwise noted.

**N8 Package
8-Lead Plastic DIP**

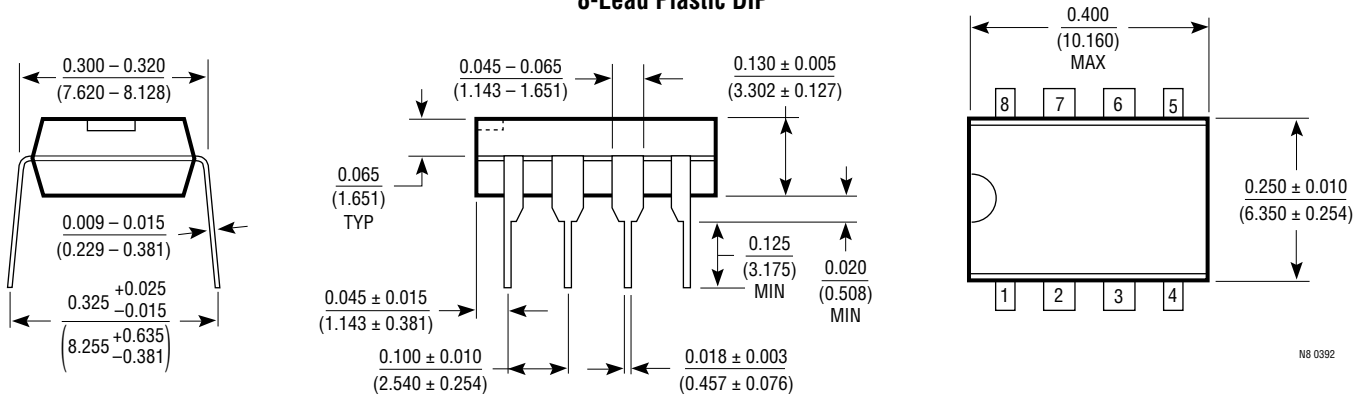

**S8 Package
8-Lead Plastic SOIC**

