

MECHANICAL DATA

**GOLD METALLISED
MULTI-PURPOSE SILICON
DMOS RF FET
400W – 50V – 175MHz
PUSH-PULL**

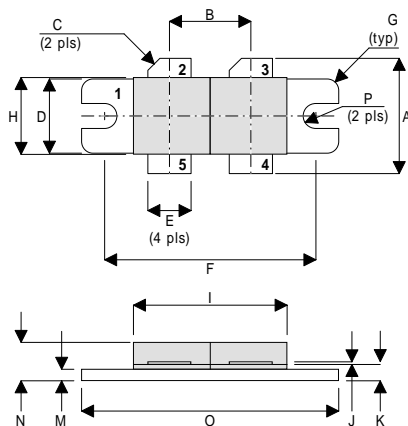

DR

PIN 1	SOURCE (COMMON)	PIN 2	DRAIN 1
PIN 3	DRAIN 2	PIN 4	GATE 2
PIN 5	GATE 1		

DIM	Millimetres	Tol.	Inches	Tol.
A	19.05	0.50	0.75	0.020
B	10.77	0.13	0.424	0.005
C	45°	5°	45°	5°
D	9.78	0.13	0.385	0.005
E	5.71	0.13	0.225	0.005
F	27.94	0.13	1.100	0.005
G	1.52R	0.13	0.060R	0.005
H	10.16	0.13	0.400	0.005
I	22.22	MAX	0.875	MAX
J	0.13	0.02	0.005	0.001
K	2.72	0.13	0.107	0.005
M	1.70	0.13	0.067	0.005
N	5.08	0.50	0.200	0.020
O	34.03	0.13	1.340	0.005
P	1.61R	0.08	0.064R	0.003

FEATURES

- SIMPLIFIED AMPLIFIER DESIGN
- SUITABLE FOR BROAD BAND APPLICATIONS
- LOW C_{rss}
- SIMPLE BIAS CIRCUITS
- LOW NOISE
- HIGH GAIN – 16 dB MINIMUM

APPLICATIONS

- VHF/UHF COMMUNICATIONS
from 1 MHz to 250 MHz

ABSOLUTE MAXIMUM RATINGS ($T_{case} = 25^{\circ}C$ unless otherwise stated)

P_D	Power Dissipation	583W
BV_{DSS}	Drain – Source Breakdown Voltage*	125V
BV_{GSS}	Gate – Source Breakdown Voltage*	±20V
$I_{D(sat)}$	Drain Current*	24A
T_{stg}	Storage Temperature	-65 to 150°C
T_j	Maximum Operating Junction Temperature	200°C

* per side

Semelab Plc reserves the right to change test conditions, parameter limits and package dimensions without notice. Information furnished by Semelab is believed to be both accurate and reliable at the time of going to press. However Semelab assumes no responsibility for any errors or omissions discovered in its use. Semelab encourages customers to verify that datasheets are current before placing orders.

ELECTRICAL CHARACTERISTICS (T_{case} = 25°C unless otherwise stated)

Parameter	Test Conditions	Min.	Typ.	Max.	Unit
PER SIDE					
B _V DSS	Drain–Source Breakdown Voltage	V _{GS} = 0	I _D = 100mA	125	V
I _{DSS}	Zero Gate Voltage Drain Current	V _{DS} = 50V	V _{GS} = 0		8 mA
I _{GSS}	Gate Leakage Current	V _{GS} = 20V	V _{DS} = 0		1 μA
V _{GS(th)}	Gate Threshold Voltage*	I _D = 10mA	V _{DS} = V _{GS}	1	7 V
g _{fs}	Forward Transconductance*	V _{DS} = 10V	I _D = 8A	6.4	mhos
V _{GS(th)match}	Gate Threshold Voltage Matching Between Sides	I _D = 10mA	V _{DS} = V _{GS}		0.1 V
TOTAL DEVICE					
G _{PS}	Common Source Power Gain	P _O = 400W		16	dB
η	Drain Efficiency	V _{DS} = 50V	I _{DQ} = 2A	50	%
VSWR	Load Mismatch Tolerance	f = 175MHz		20:1	—
PER SIDE					
C _{iss}	Input Capacitance	V _{DS} = 50V	V _{GS} = -5V f = 1MHz		480 pF
C _{oss}	Output Capacitance	V _{DS} = 50V	V _{GS} = 0 f = 1MHz		200 pF
C _{rss}	Reverse Transfer Capacitance	V _{DS} = 50V	V _{GS} = 0 f = 1MHz		12 pF

* Pulse Test: Pulse Duration = 300 μs , Duty Cycle ≤ 2%

HAZARDOUS MATERIAL WARNING

The ceramic portion of the device between leads and metal flange is beryllium oxide. Beryllium oxide dust is highly toxic and care must be taken during handling and mounting to avoid damage to this area.

THESE DEVICES MUST NEVER BE THROWN AWAY WITH GENERAL INDUSTRIAL OR DOMESTIC WASTE.

THERMAL DATA

R _{THj-case}	Thermal Resistance Junction – Case	Max. 0.3°C / W
-----------------------	------------------------------------	----------------

Semelab Plc reserves the right to change test conditions, parameter limits and package dimensions without notice. Information furnished by Semelab is believed to be both accurate and reliable at the time of going to press. However Semelab assumes no responsibility for any errors or omissions discovered in its use. Semelab encourages customers to verify that datasheets are current before placing orders.

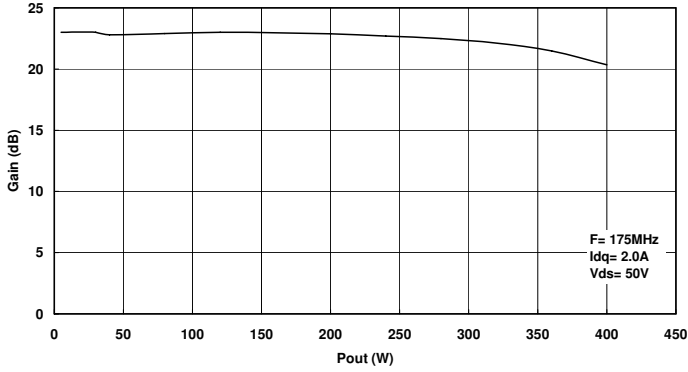

Figure 1
Gain vs. Output Power.

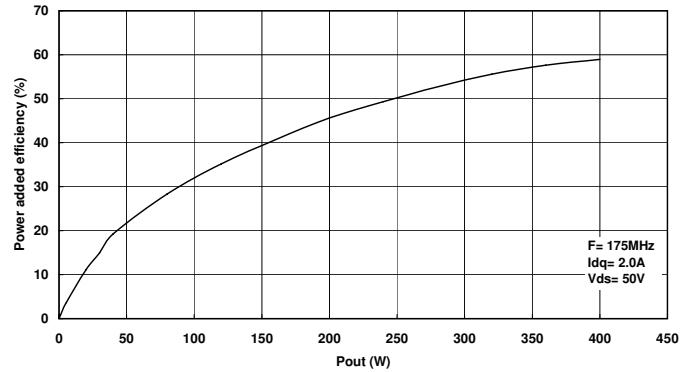

Figure 2
Power added efficiency vs. Output Power

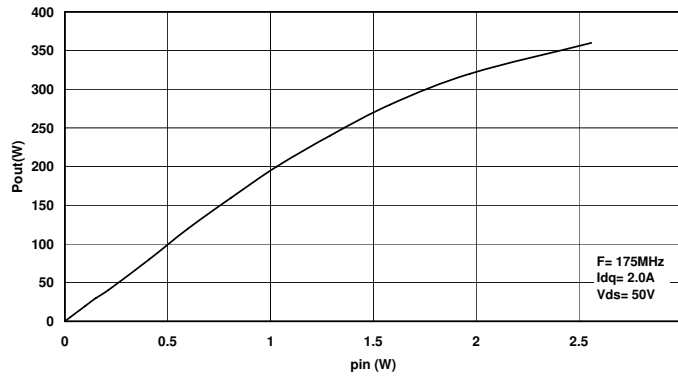

Figure 3
Output Power vs. Input Power.

Typical S Parameters

! $V_{DS}50V, I_{DQ} = 1.4A$
MHz S M A R 50

!Freq !MHz	S11		S21		S12		S22	
	mag	ang	mag	ang	mag	ang	mag	ang
50	0.83	-165.3	20.29	69.4	0.007	-9.2	0.63	-150.7
100	0.89	-170	8.28	48.6	0.004	-6	0.78	-156.6
150	0.93	-173.2	4.42	35.6	0.003	50	0.86	-162
200	0.95	-175.7	2.71	27.2	0.005	82.4	0.91	-166.2
250	0.97	-177.8	1.82	21.3	0.008	88.8	0.94	-169.4
300	0.98	-179.7	1.3	17	0.011	90	0.95	-171.9
350	0.98	178.7	0.97	13.8	0.014	89.6	0.97	-174
400	0.98	177.3	0.76	11.4	0.017	88.9	0.97	-175.7
450	0.99	175.9	0.61	9.5	0.02	87.9	0.98	-177.3
500	0.99	174.7	0.5	8.1	0.023	86.9	0.98	-178.6
550	0.99	173.5	0.42	7.1	0.026	85.9	0.98	-179.8
600	0.99	172.3	0.35	6.5	0.028	84.9	0.99	179

Semelab Plc reserves the right to change test conditions, parameter limits and package dimensions without notice. Information furnished by Semelab is believed to be both accurate and reliable at the time of going to press. However Semelab assumes no responsibility for any errors or omissions discovered in its use. Semelab encourages customers to verify that datasheets are current before placing orders.

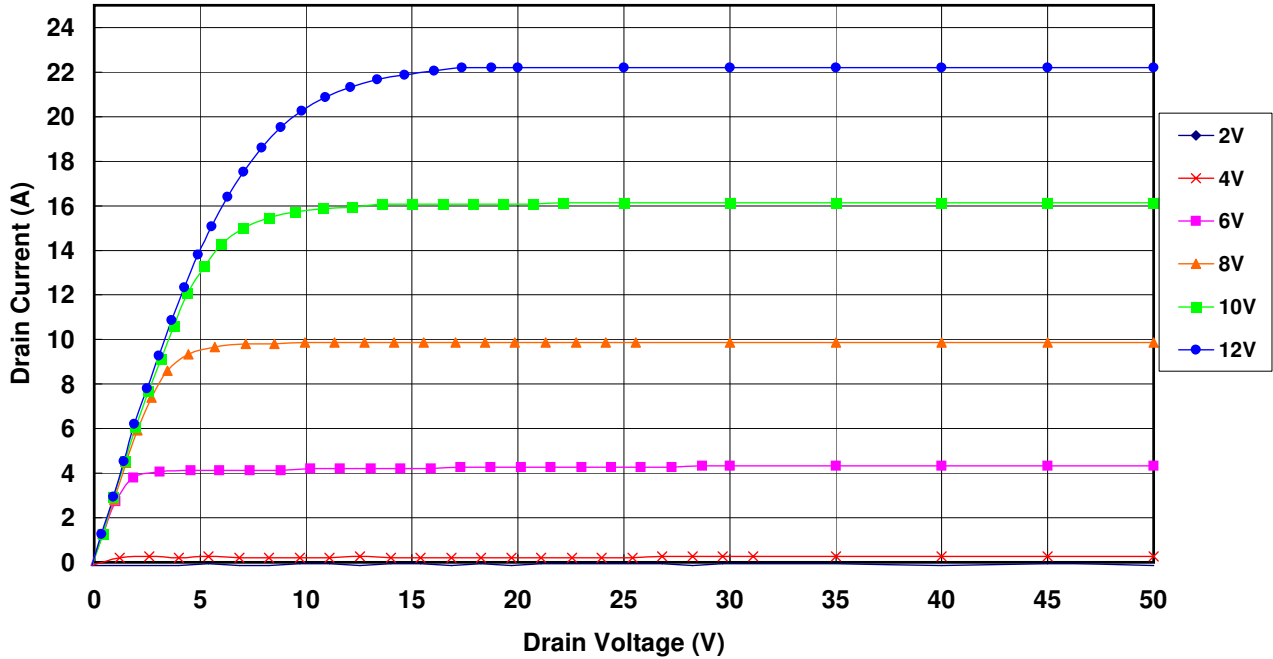

Figure 5 – Typical IV Characteristics.

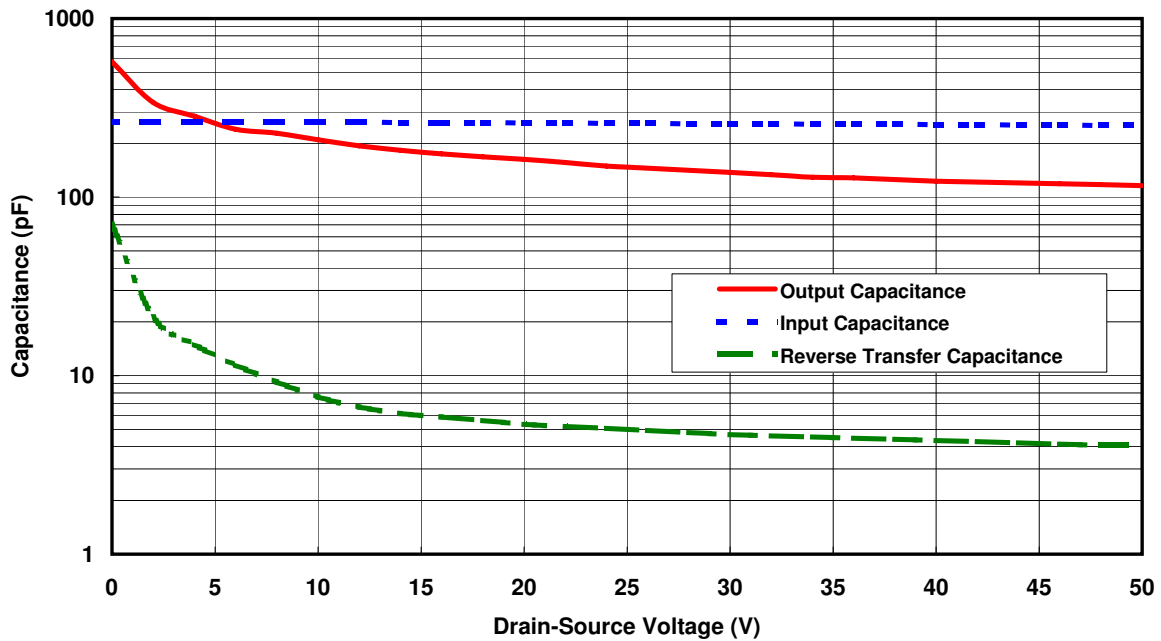
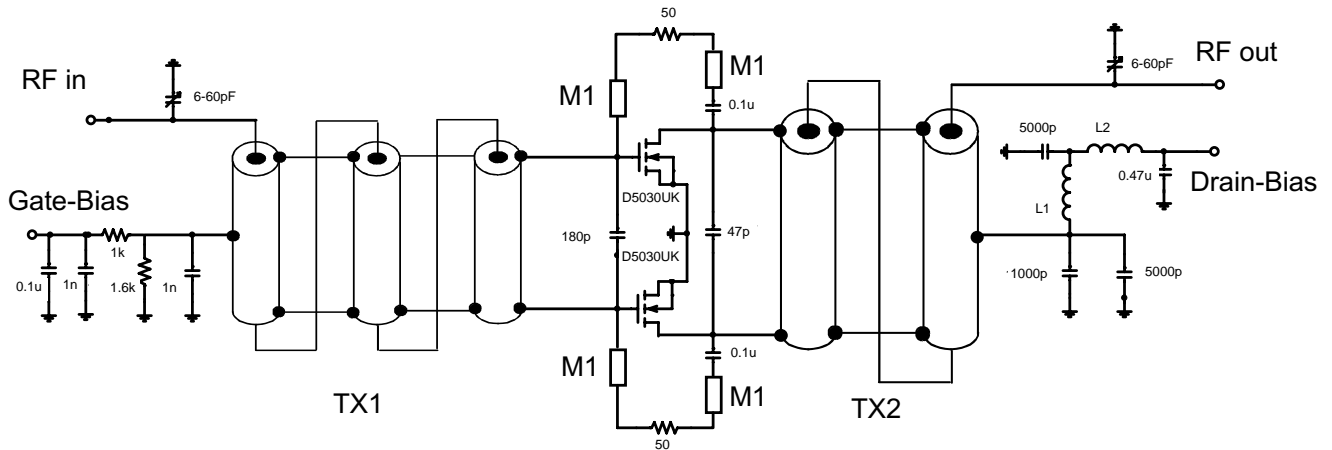

Figure 6 – Typical CV Characteristics.

Semelab Plc reserves the right to change test conditions, parameter limits and package dimensions without notice. Information furnished by Semelab is believed to be both accurate and reliable at the time of going to press. However Semelab assumes no responsibility for any errors or omissions discovered in its use. Semelab encourages customers to verify that datasheets are current before placing orders.



TX1 9:1 transformer. 3 turns of 062-25 semi-rigid coax around 75-26 powdered iron core

TX2 4:1 transformer. 2 turns of 090-25 semi-rigid coax around 100-8 powdered iron core

L1 10 turns 16 awg enamelled wire, 5mm internal diameter

L2 0.5 turns 16 awg enamelled wire on A1 x 1 2-hole core

M1 microstrip line, 20mm long, 1mm wide on 0.062in thick G10 substrate

D5030UK 175MHz TEST FIXTURE