

SHINDENGEN

Schottky Rectifiers (SBD)

Single

D3S4M

40V 3A

FEATURES

- Tj150°C
- P_{RRSM} avalanche guaranteed
- 1.4 φ lead

APPLICATION

- Switching power supply
- DC/DC converter
- Home Appliances, Office Equipment
- Telecommunication

OUTLINE DIMENSIONS

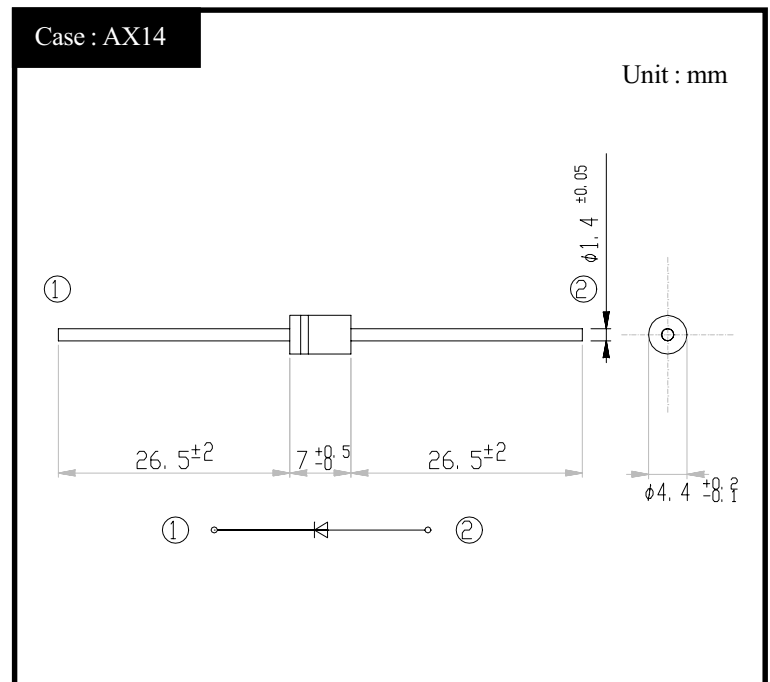

RATINGS

● Absolute Maximum Ratings (If not specified Tl=25°C)

Item	Symbol	Conditions	Ratings	Unit
Storage Temperature	T _{stg}		-40 ~ 150	°C
Operating Junction Temperature	T _j		150	°C
Maximum Reverse Voltage	V _{RM}		40	V
Repetitive Peak Surge Reverse Voltage	V _{RRSM}	Pulse width 0.5ms, duty 1/40	45	V
Average Rectified Forward Current	I _O	50Hz sine wave, R-load With heatsink T _a =63°C	3	A
		50Hz sine wave, R-load Without heatsink T _a =58°C	2	
Peak Surge Forward Current	I _{FSM}	50Hz sine wave, Non-repetitive 1 cycle peak value, T _j =125°C	80	A
Repetitive Peak Surge Reverse Power	P _{RRSM}	Pulse width 10 μs, T _j =25°C	330	W

● Electrical Characteristics (If not specified Tl=25°C)

Item	Symbol	Conditions	Ratings	Unit
Forward Voltage	V _F	I _F =3A, Pulse measurement	Max 0.55	V
Reverse Current	I _R	V _R =V _{RM} , Pulse measurement	Max 3.5	mA
Junction Capacitance	C _j	f=1MHz, V _R =10V	Typ 150	pF
Thermal Resistance	θ _{jl}	junction to lead	Max 6.5	°C/W
	θ _{ja}	junction to ambient On glass-epoxy substrate	Max 64	
		junction to ambient With heatsink (20mm×20mm×1mm)	Max 36	

D3S4M

Forward Voltage

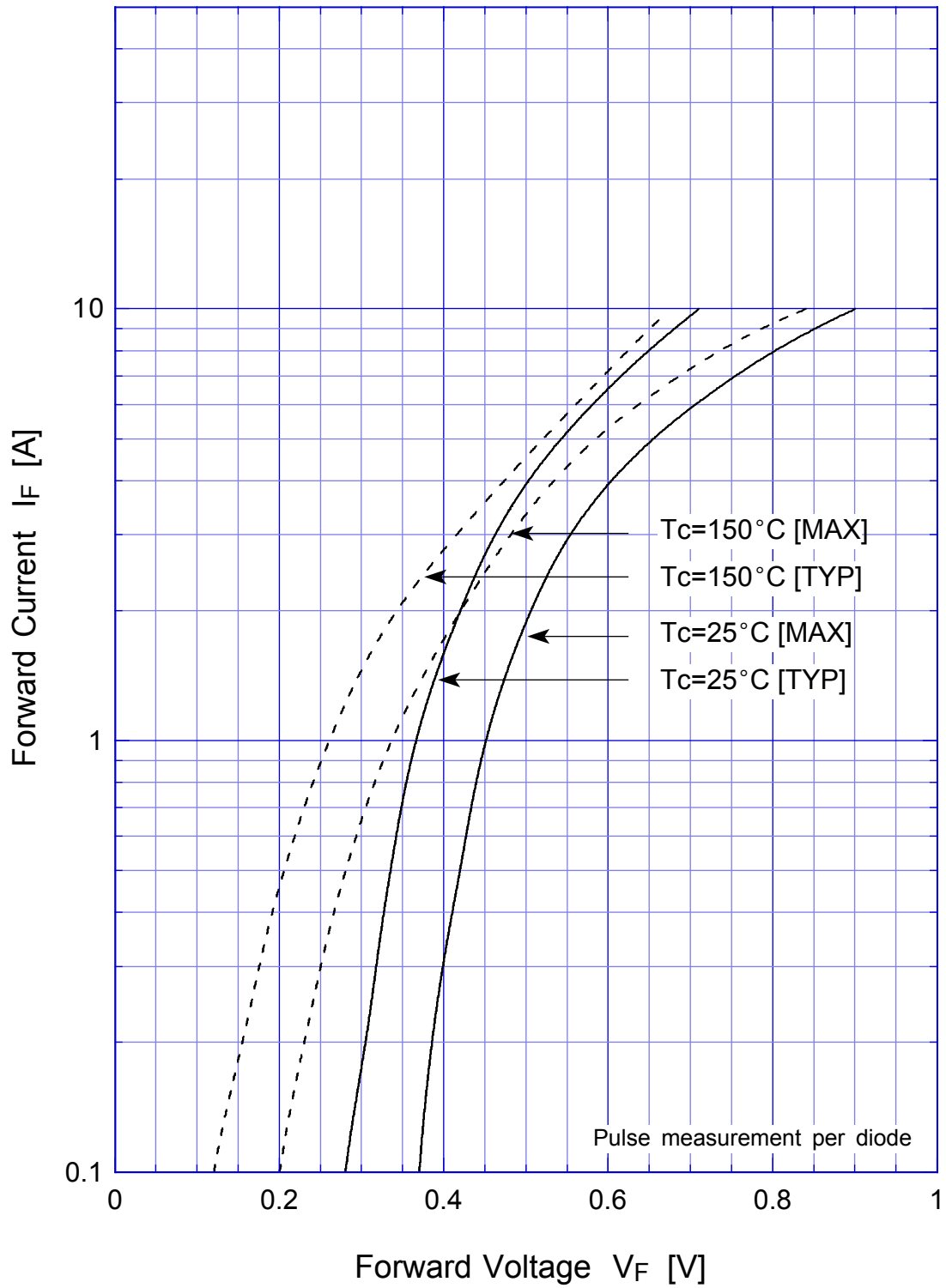

D3S4M

Reverse Power Dissipation

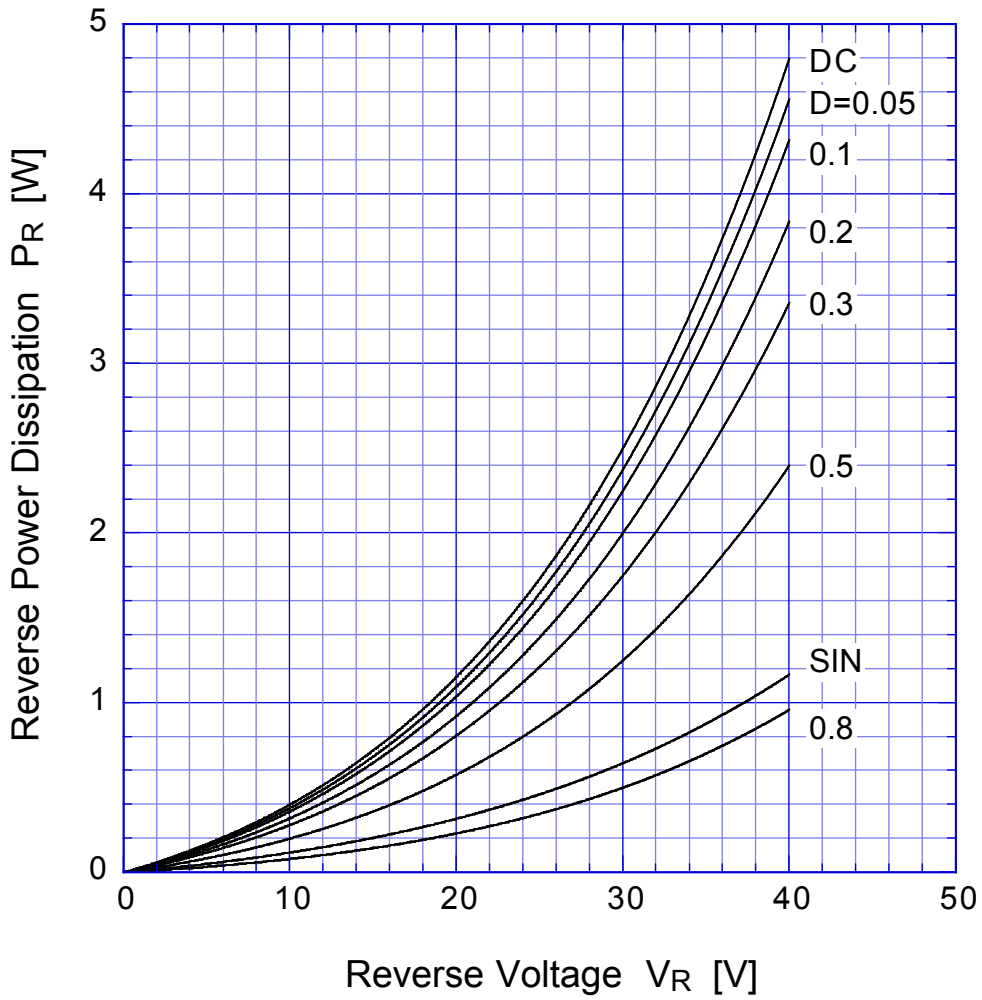

$T_j = 150^\circ\text{C}$

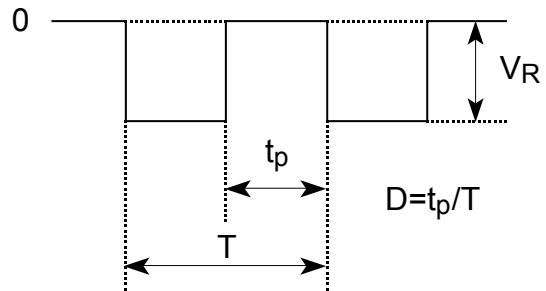

D3S4M

Forward Power Dissipation

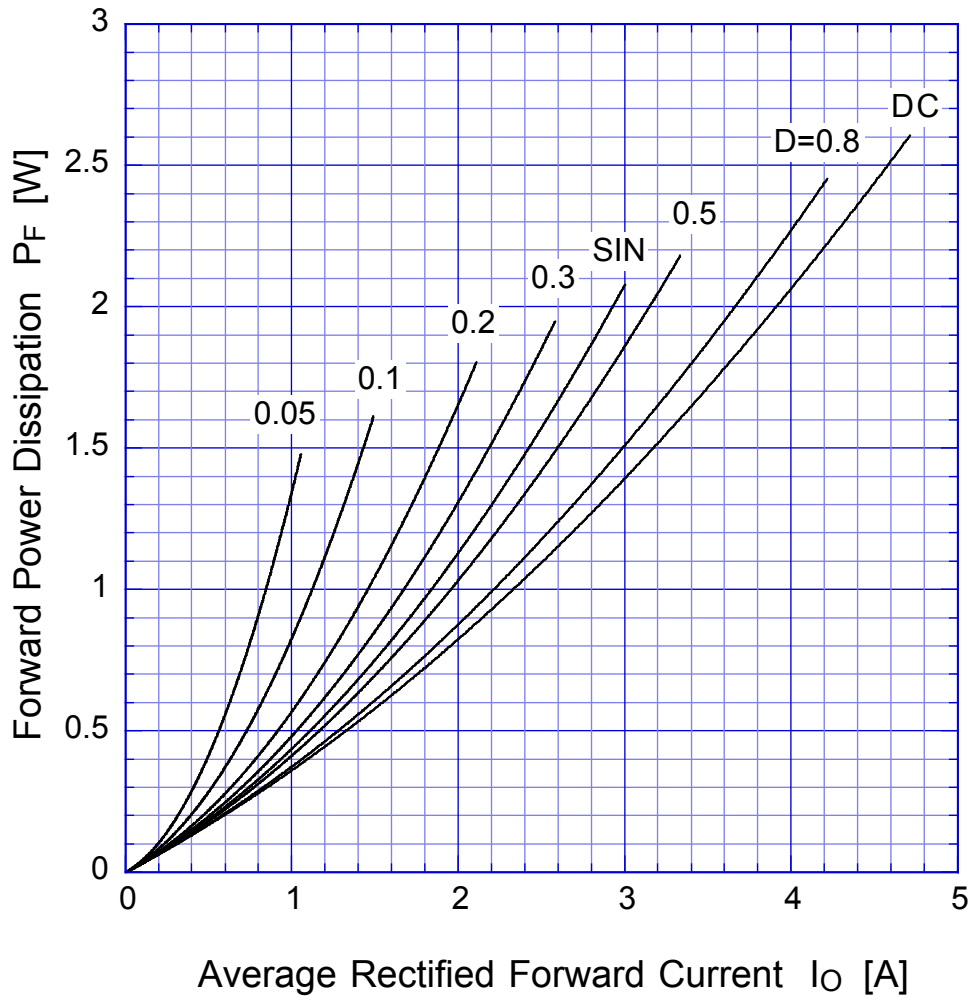

$T_j = 150^\circ\text{C}$

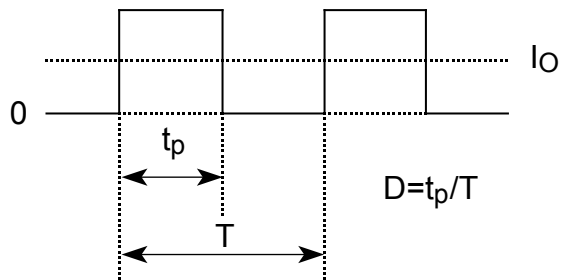

D3S4M

Derating Curve

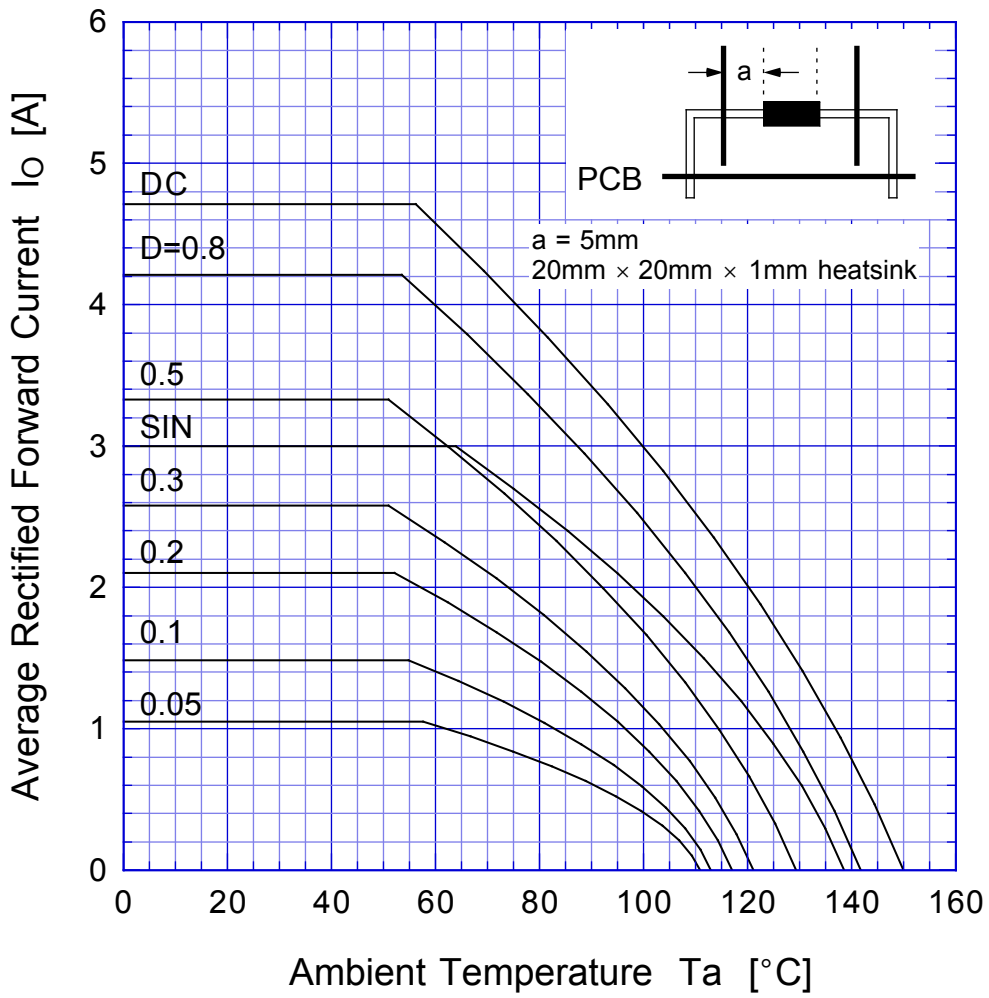

$V_R = 20V$



D3S4M

Derating Curve

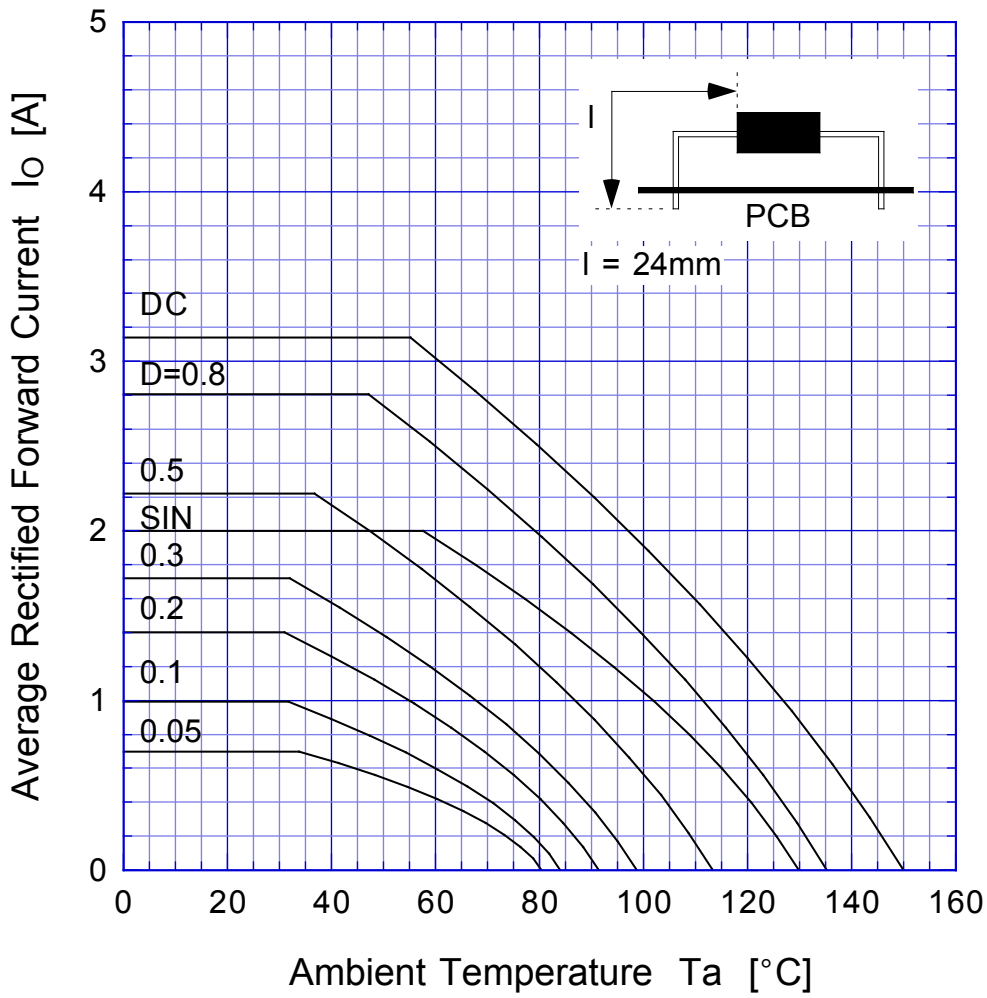

$V_R = 20\text{V}$

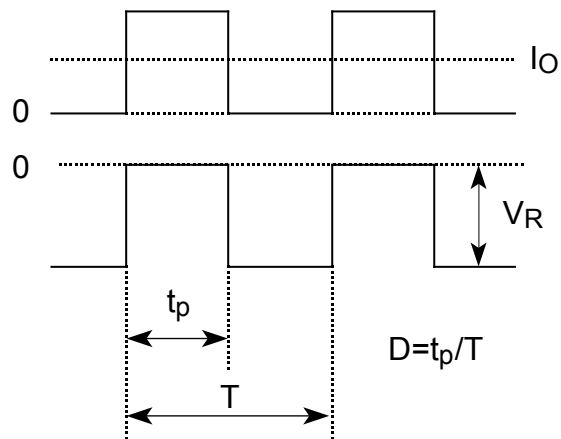

D3S4M

Derating Curve

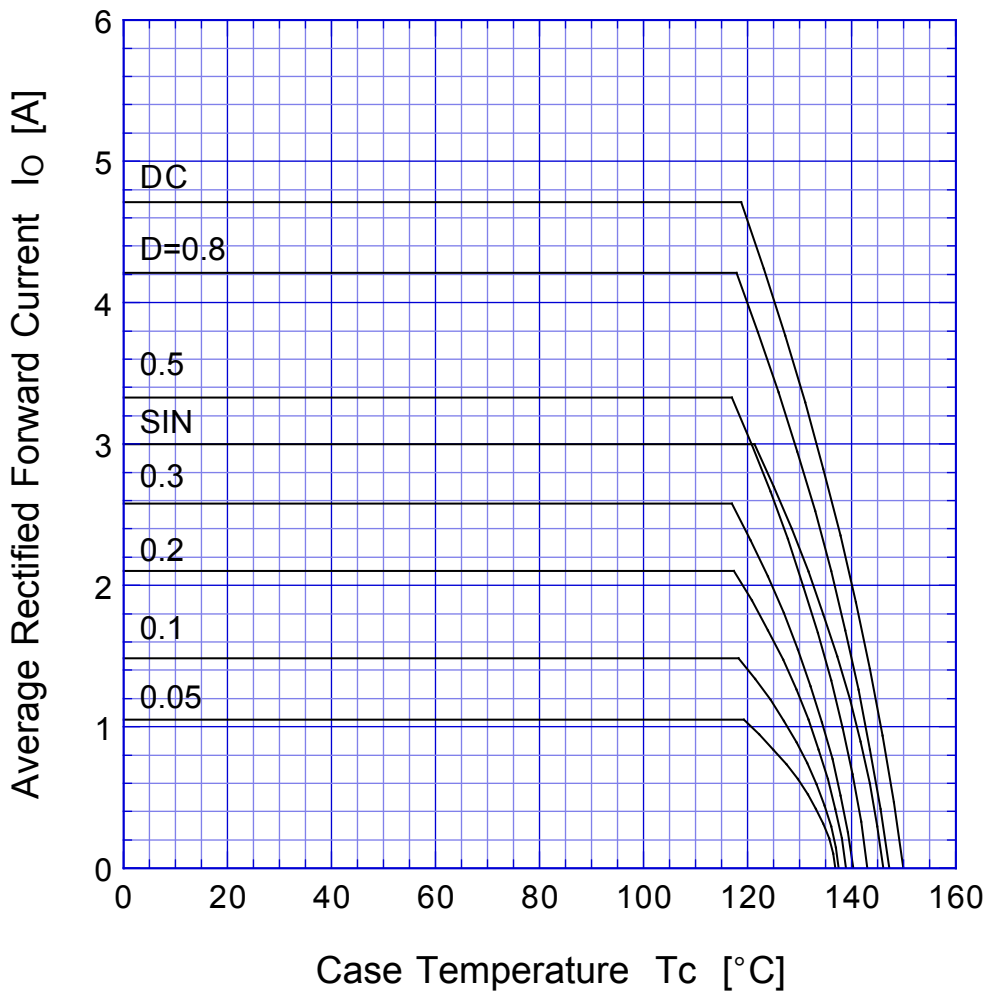

$V_R = 20V$



D3S4M

Peak Surge Forward Capability

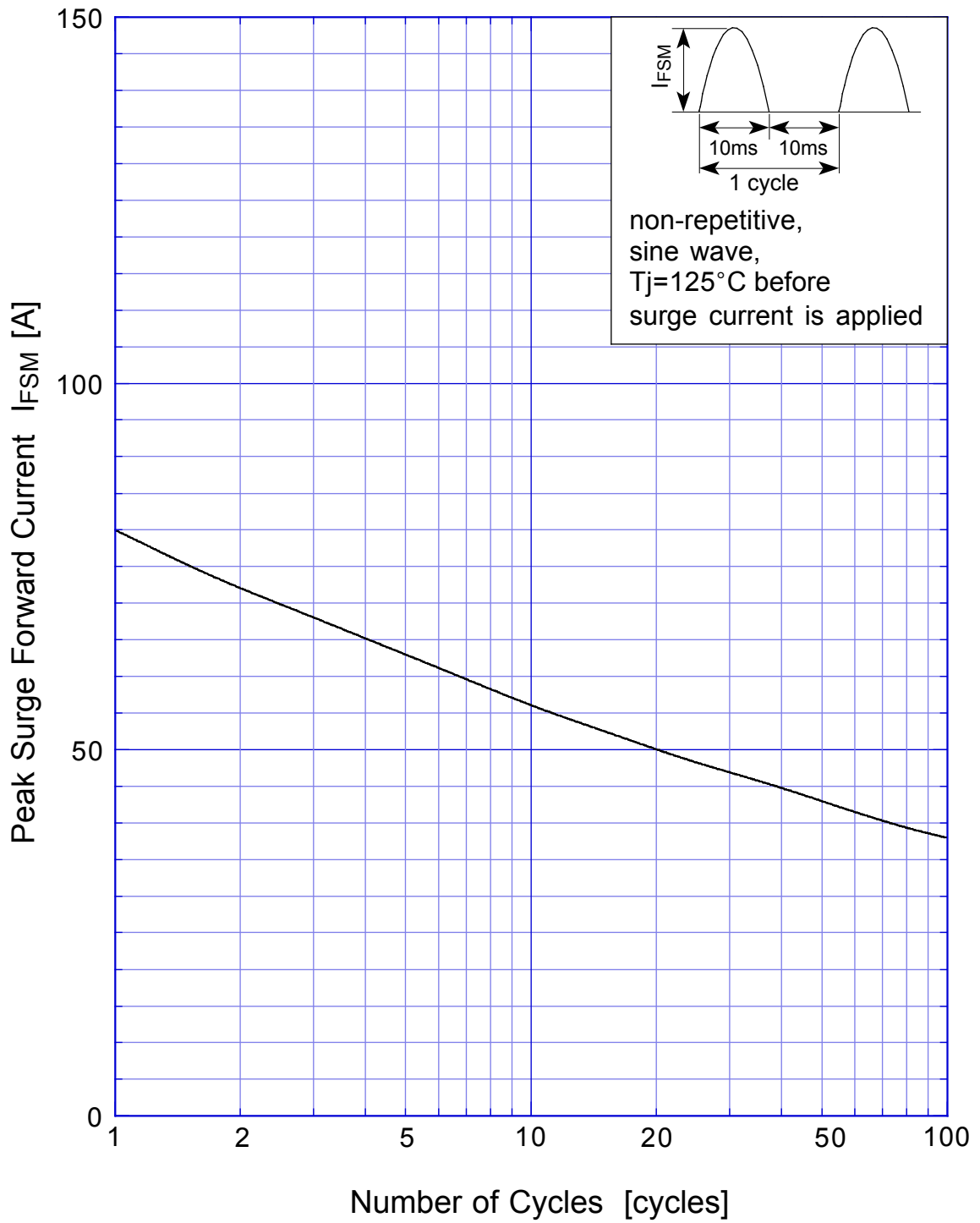

SBD Repetitive Surge Reverse Power Derating Curve



SBD

Repetitive Surge Reverse Power Capability

