

POWER TVS COMPONENT
APPLICATIONS

- ✓ Relay Drives
- ✓ Motor (Start/Stop) Back EMF Protection
- ✓ Module Lightning Protection

IEC COMPATIBILITY (EN61000-4)

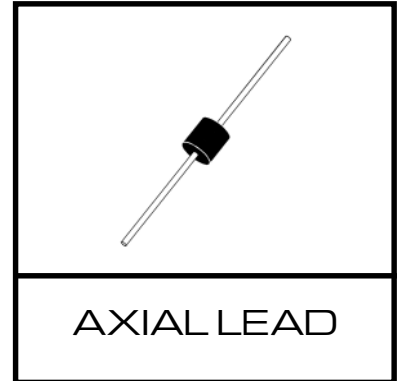
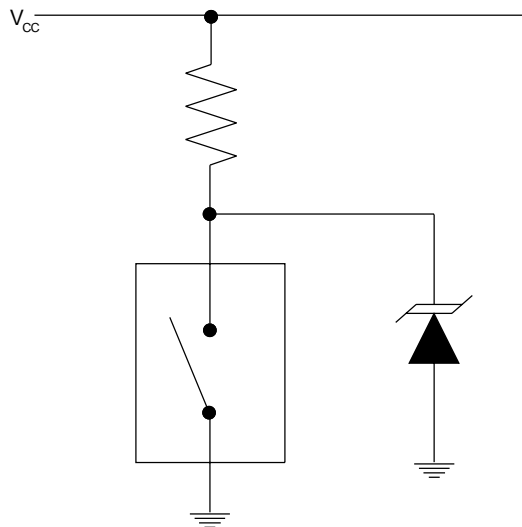
- ✓ 61000-4-5 (Surge): 8/20 μ s - 95A, L4 (Line-Gnd), 167A, L3 (Power) & 48A, L4 (Line-Line)

FEATURES

- ✓ 30,000 Watts Peak Pulse Power per Line (10/1000 μ s)
- ✓ Unidirectional & Bidirectional Configurations
- ✓ Easy Mounting to Printed Circuit Boards
- ✓ Available in Voltage Types Ranging From: 30V to 280V

MECHANICAL CHARACTERISTICS

- ✓ Molded Case
- ✓ Weight 2.5 grams (Approximate)
- ✓ Flammability Rating UL 94V-0
- ✓ Positive Terminal Marked with Band - *Unidirectional Devices*
- ✓ Marking: Logo & Part Number


APPLICATION
TYPICAL RELAY DRIVE PROTECTION


30KPA30A thru 30KPA280A

DEVICE CHARACTERISTICS

MAXIMUM RATINGS @ 25°C Unless Otherwise Specified			
PARAMETER	SYMBOL	VALUE	UNITS
Peak Pulse Power Dissipation ($t_p = 10/1000\mu s$) - See Fig. 1	P_{PP}	30,000	Watts
Forward Surge Rating (1/20 seconds) - See Note 2	I_F	200	Amps
Steady State Power Dissipation	P_D	1.0	Watts
Storage Temperature	T_{STG}	-55 to +150	$^{\circ}C$
Operating Temperature	T_J	-55 to +150	$^{\circ}C$

ELECTRICAL CHARACTERISTICS						
PART NUMBER (Notes 1 & 2)	RATED STAND-OFF VOLTAGE V_{WM} VOLTS	BREAKDOWN VOLTAGE		MAXIMUM LEAKAGE CURRENT @ V_{WM} I_D μA	MAXIMUM CLAMPING VOLTAGE (See Fig. 2) @ 10/1000 μs V_C @ I_{PP}	TEMPERATURE COEFFICIENT OF $V_{(BR)}$ $\theta V_{(BR)}$ mV/ $^{\circ}C$
		MIN $V_{(BR)}$ VOLTS	@ I_T mA			
30KPA30A	30.0	33.3	50	5000	55.2V @ 543.0A	34
30KPA36A	36.0	40.0	50	2000	61.8V @ 485.0A	41
30KPA43A	43.0	47.8	50	1000	73.0V @ 410.0A	50
30KPA48A	48.0	53.3	5	250	77.4V @ 388.0A	56
30KPA64A	64.0	71.1	5	10	104.0V @ 294.0A	76
30KPA70A	70.0	77.8	5	10	109.0V @ 274.0A	83
30KPA75A	75.0	83.3	5	10	119.4V @ 251.0A	89
30KPA90A	90.0	100.0	5	10	147.0V @ 206.0A	109
30KPA160A	160.0	178.0	5	10	252.6V @ 119.0A	195
30KPA180A	180.0	200.0	5	10	291 @ 104A	230
30KPA260A	260.0	289.0	5	10	416.0V @ 72.0A	317
30KPA280A	280.0	311.0	5	10	464.0V @ 65.0A	342

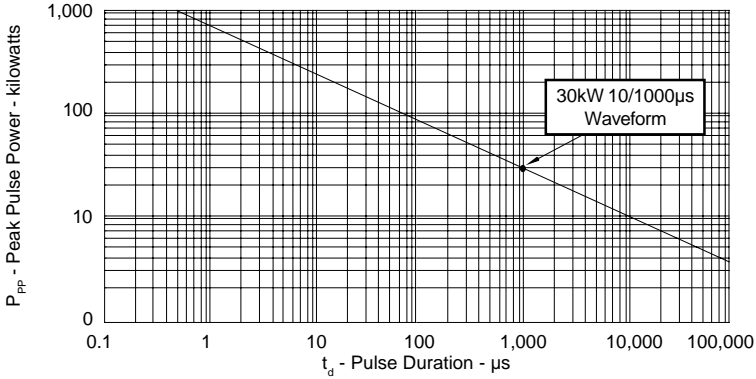
Note 1: Part numbers shown are unidirectional devices. Add a "CA" suffix to specify bidirectional devices, such as 30KPA30CA. *Devices shown are preferred voltages. Contact factory for additional voltages.*

Note 2: $V_F = 15$ Volts @ 200A, 8.3ms (1/2 Sine Wave) - *unidirectional devices only.*

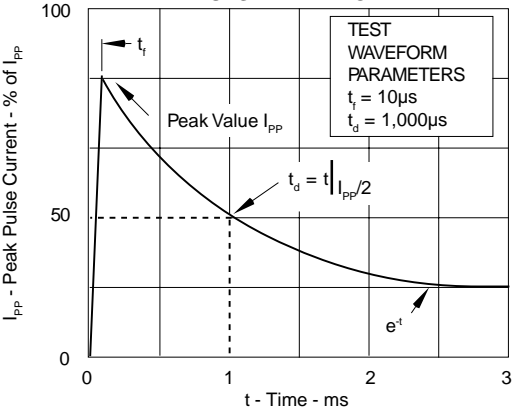
30KPA30A thru 30KPA280A

GRAPHS

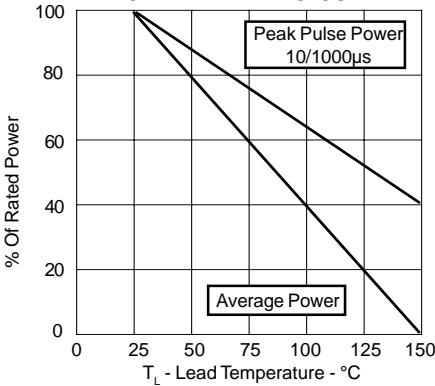
**FIGURE 1
PEAK PULSE POWER VS PULSE TIME**



**FIGURE 2
PULSE WAVE FORM**

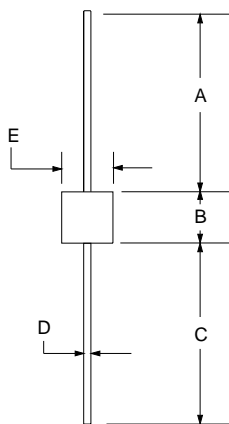



**FIGURE 3
POWER DERATING CURVE**



30KPA30A thru 30KPA280A

PACKAGE OUTLINE & DIMENSIONS

<p>PACKAGE OUTLINE</p> 	<p>30KPA</p> 			
PACKAGE DIMENSIONS				
DIM	MILLIMETERS		INCHES	
	MIN	MAX	MIN	MAX
A	24.5	-	1.00	-
B	8.60	9.10	0.34	0.36
C	24.5	-	1.00	-
D	1.20 DIA	1.30 DIA	0.048 DIA	0.052 DIA
E	8.60	9.10	0.34	0.36
NOTES:				
1. Dimensions are exclusive of mold flash and metal burrs.				
06028 Rev 0 - 12/01				

Protek Devices
 2929 South Fair Lane, Tempe, AZ 85282
 Tel: 602-431-8101 Fax: 602-431-2288
 E-Mail: sales@protekdevices.com
 Web Site: www.protekdevices.com

COPYRIGHT © ProTek Devices 2002

SPECIFICATIONS: ProTek reserves the right to change the electrical and or mechanical characteristics described herein without notice (except JEDEC).

DESIGN CHANGES: ProTek reserves the right to discontinue product lines without notice, and that the final judgement concerning selection and specifications is the buyer's and that in furnishing engineering and technical assistance, ProTek assumes no responsibility with respect to the selection or specifications of such products.