

FRED Ultrafast Soft Recovery Diode, 80 A

FEATURES

- Ultrafast recovery
- 175 °C operating junction temperature
- Designed and qualified for industrial level

BENEFITS

- Reduced RFI and EMI
- Higher frequency operation
- Reduced snubbing
- Reduced parts count

DESCRIPTION/APPLICATIONS

These diodes are optimized to reduce losses and EMI/RFI in high frequency power conditioning systems.

The softness of the recovery eliminates the need for a snubber in most applications. These devices are ideally suited for HF welding, power converters and other applications where switching losses are not significant portion of the total losses.

N-80EPU12



Cathode to base

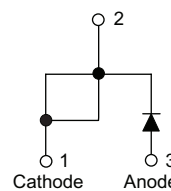

TO-247AC modified

N-80APU12

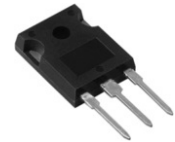

Cathode to base

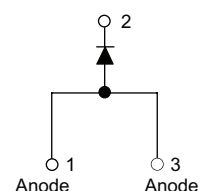

TO-247AB

PRODUCT SUMMARY

t_{rr}	35 ns
$I_{F(AV)}$	80 A
V_R	1200 V

ABSOLUTE MAXIMUM RATINGS

PARAMETER	SYMBOL	TEST CONDITIONS	VALUES	UNITS
Cathode to anode voltage	V_R		1200	V
Continuous forward current	$I_{F(AV)}$	$T_C = 110\text{ °C}$	80	A
Single pulse forward current	I_{FSM}	$T_C = 25\text{ °C}$	610	
Maximum repetitive forward current	I_{FRM}	Square wave, 20 kHz	129	
Operating junction and storage temperatures	T_j, T_{Stg}		- 55 to 175	°C

ELECTRICAL SPECIFICATIONS (T_J = 25 °C unless otherwise specified)

PARAMETER	SYMBOL	TEST CONDITIONS	MIN.	TYP.	MAX.	UNITS
Breakdown voltage, blocking voltage	V_{BR}, V_f	$I_R = 100\mu A$	1200	-	-	V
Forward voltage	V_F	$I_F = 80A$	-	2.8	3.3	
		$I_F = 160A$	-	3.3	-	
Reverse leakage current	I_R	$V_R = V_R \text{ rated}$	-	-	100	μA
		$T_J = 150\text{ °C}, V_R = V_R \text{ rated}$	-	-	500	
Junction capacitance	C_T	$V_R = 200V$	-	50	-	pF

DYNAMIC RECOVERY CHARACTERISTICS (T _J = 25 °C unless otherwise specified)						
PARAMETER	SYMBOL	TEST CONDITIONS	MIN.	TYP.	MAX.	UNITS
Reverse recovery time	t _{rr}	I _F = 0.5A, I _R = 1A, I _{RR} =0.25A	-	35	40	ns
		I _F = 1A, dI _F /dt = 100 A/μs, V _R =30V	-	30	-	
		T _J = 25°C	-	330	-	
		T _J = 125°C	-	430	-	
Peak recovery current	I _{RRM}	T _J = 25°C	-	5	-	A
		T _J = 125°C	-	13	-	
Reverse recovery charge	Q _{rr}	T _J = 25°C	-	740	-	nC
		T _J = 125°C	-	3450	-	

THERMAL - MECHANICAL SPECIFICATIONS						
PARAMETER	SYMBOL	TEST CONDITIONS	MIN.	TYP.	MAX.	UNITS
Thermal resistance, junction to case	R _{thJC}		-	-	0.3	°C/W
Thermal resistance, case to heatsink	R _{thCS}	Mounting surface, flat, smooth and greased	-	0.39	-	
Weight			-	5.9	-	g
			-	0.22	-	oz.
Mounting torque			0.6 (5)	-	1.2 (10)	N · m (lbf · in)
Marking device		Case style TO-247AC modified	80EPU12			
		Case style TO-247AC	80APU12			

Fig.1 Maximum effective transient thermal impedance, junction-to-case vs. pulse duration

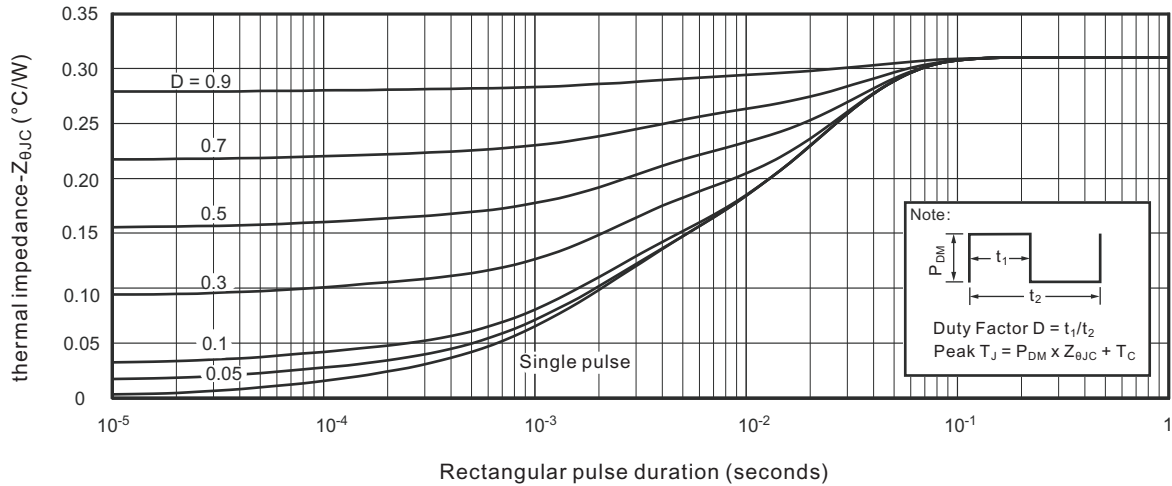

Fig.2 Forward current vs. forward voltage

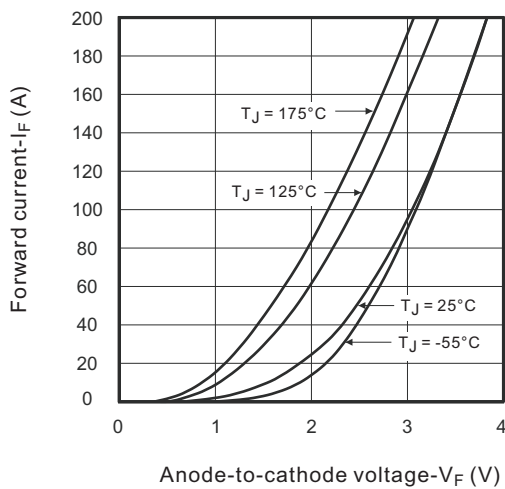

Fig.3. Reverse recovery time vs. current rate of change

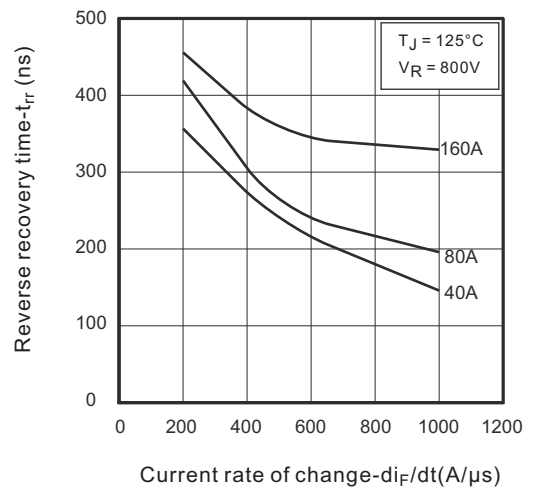

Fig.4 Reverse recovery charge vs. current rate of change

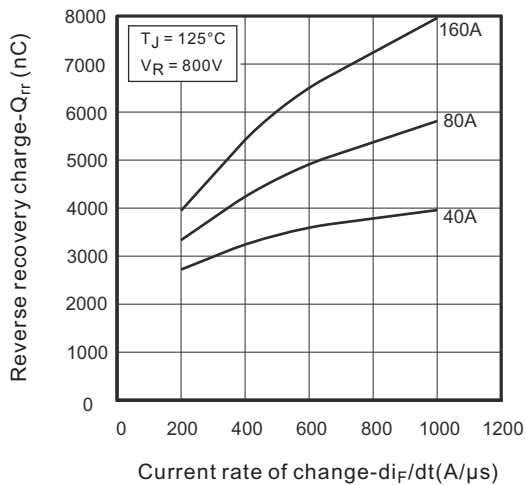
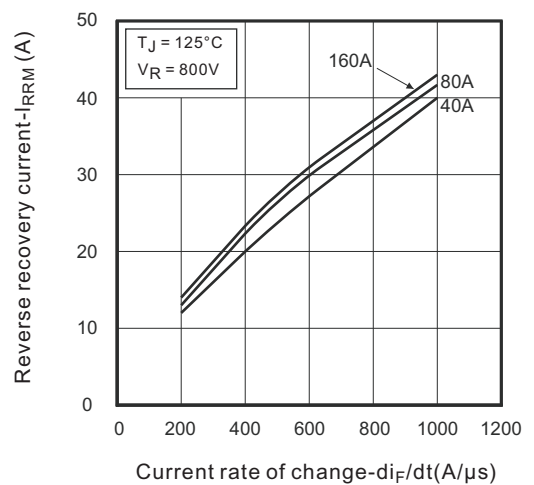

Fig.5 Reverse recovery current vs. current rate of change



Nell High Power Products

Fig.6 Dynamic parameters vs. junction temperature

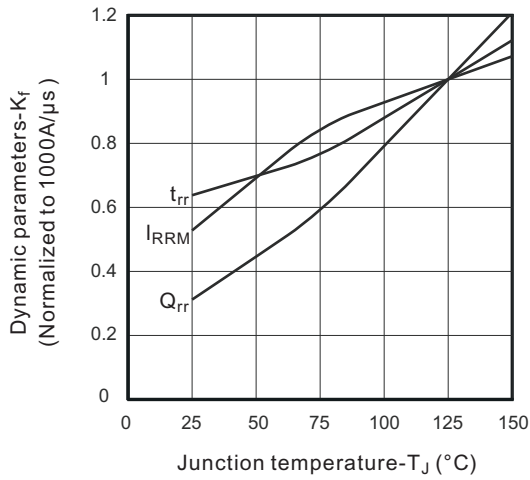

Fig.7 Maximum average forward current vs. case temperature

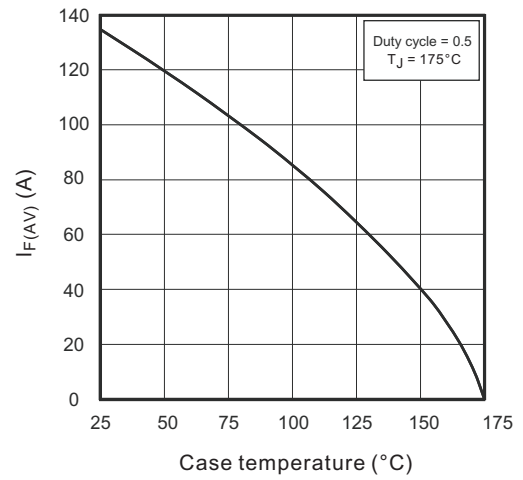
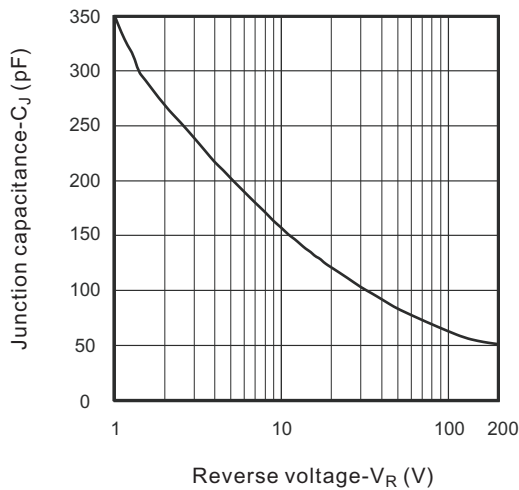
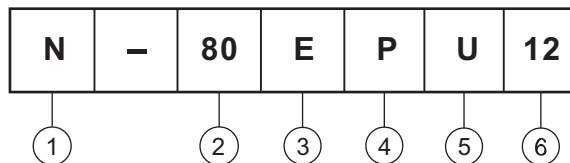

Fig.8 Junction capacitance vs. reverse voltage



Ordering Information Tabel

Device code



- 1 - Nell
- 2 - Current rating (80 = 80A)
- 3 - Single Diode
- 4 - TO-247AC (Modified)
- 5 - Ultrafast Recovery
- 6 - Voltage Rating (12 = 1200 V)

E = 2 pins
A = 3 pins

Fig.9 Reverse recovery parameter test circuit

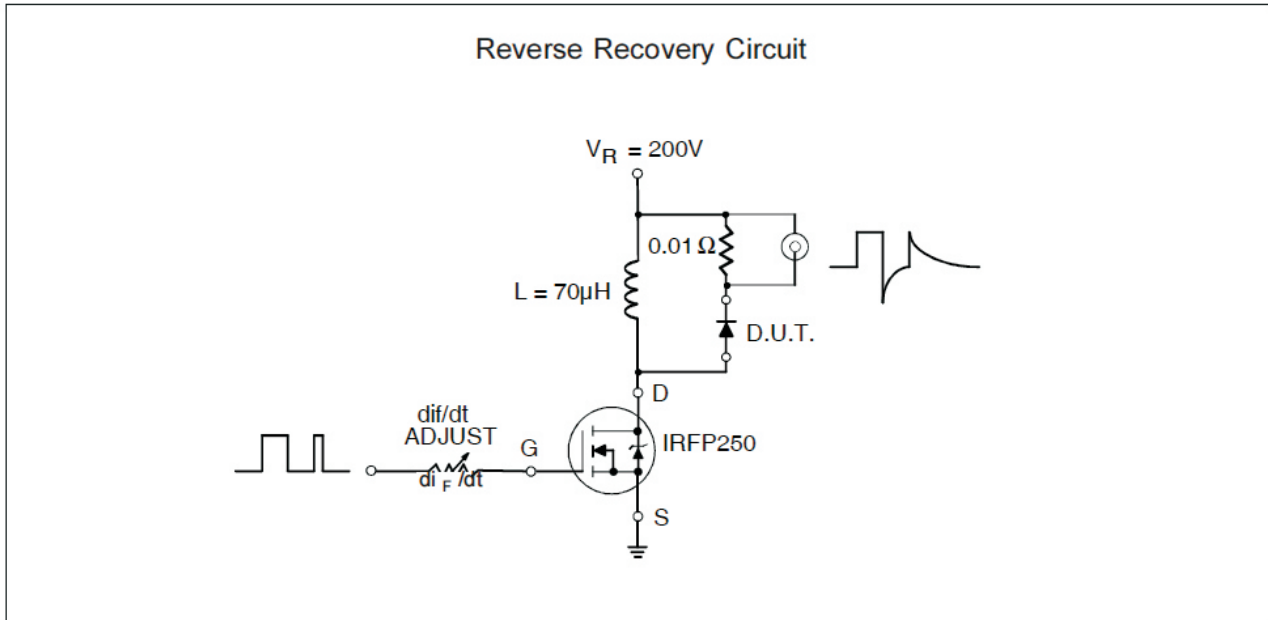

- (3) Formula used: $T_C = T_J - (Pd + Pd_{REV}) \times R_{thJC}$;
 $Pd = \text{Forward Power Loss} = I_{F(AV)} \times V_{FM} @ (I_{F(AV)} / D)$ (see Fig. 6);
 $Pd_{REV} = \text{Inverse Power Loss} = V_{R1} \times I_R (1 - D)$; $I_R @ V_{R1} = 80\% \text{ rated } V_R$

Fig.10 Reverse recovery waveform and definitions

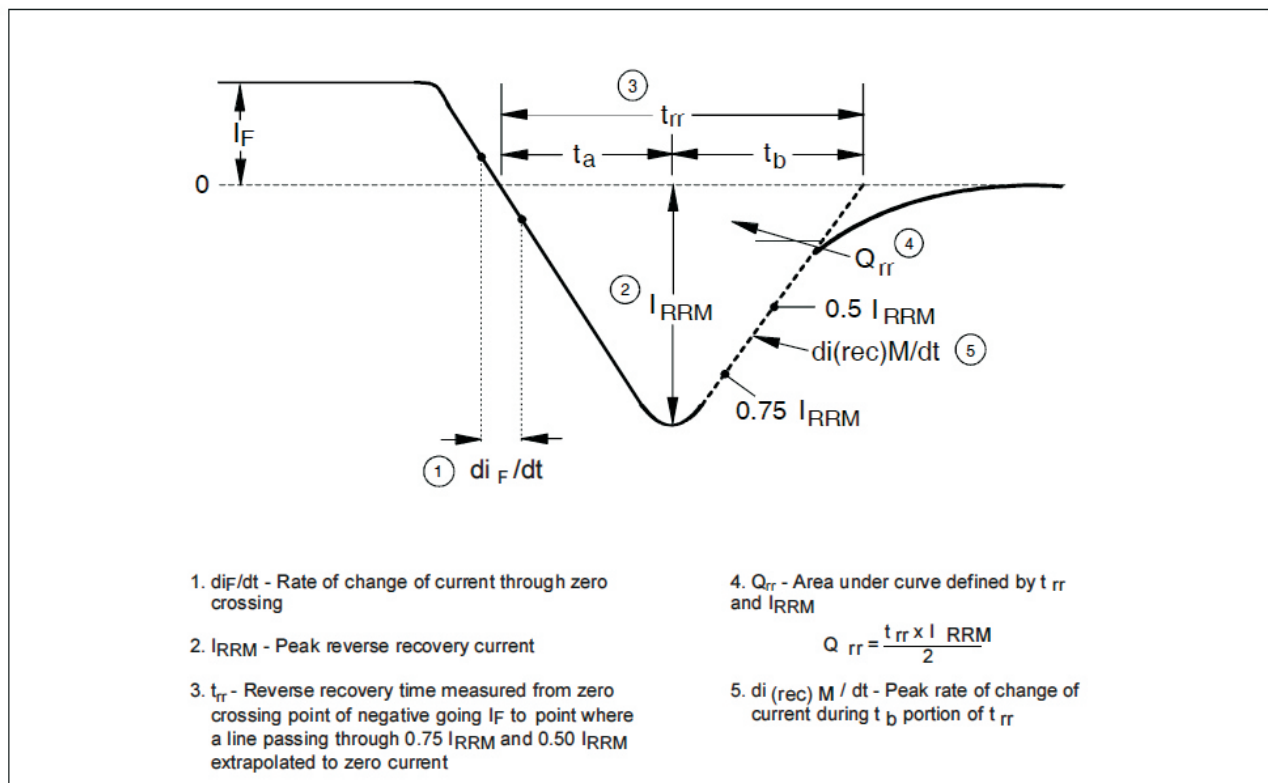

Outline Table

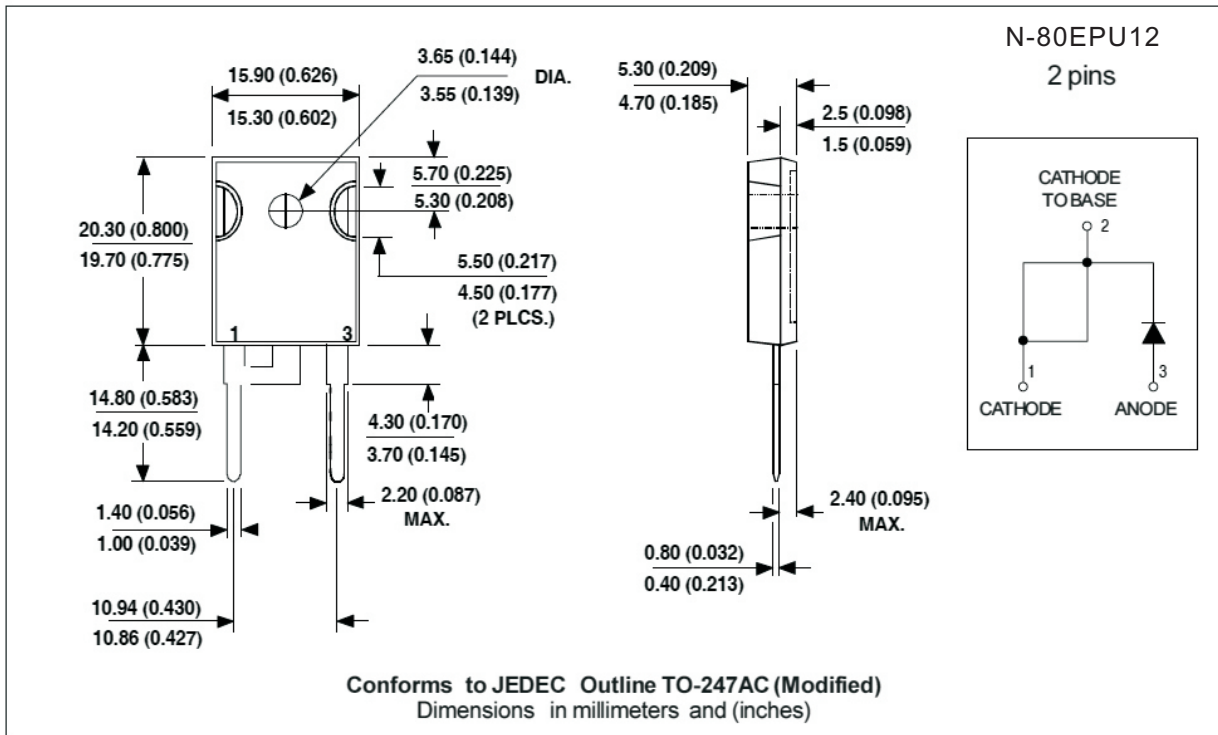

Outline Table

