

1. SCOPE

1.1 Scope. This drawing describes the requirements for class B microcircuits in accordance with 1.2.1 of MIL-STD-883, "Provisions for the use of MIL-STD-883 in conjunction with compliant non-JAN devices".

1.2 Part number. The complete part number shall be as shown in the following example:

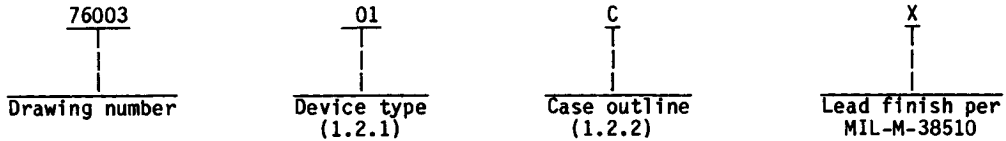

1.2.1 Device type. The device type shall identify the circuit function as follows:

| Device type | Generic number | Circuit function |
|-------------|----------------|--|
| 01 | 54LS122 | Single retriggerable monostable multivibrator with clear |

1.2.2 Case outlines. The case outlines shall be as designated in appendix C of MIL-M-38510, and as follows:

| Outline letter | Case outline |
|----------------|--|
| C | D-1 (14-lead, 1/4" x 3/4"), dual-in-line package |
| D | F-2 (14-lead, 1/4" x 3/8"), flat package |
| 2 | C-2 (20-terminal, .350" x .350"), chip carrier package |

1.3 Absolute maximum ratings.

| | |
|---|----------------------------------|
| Supply voltage range - - - - - | -0.5 V dc to +7.0 V dc |
| Input voltage range - - - - - | -1.5 V dc at -18 mA to +5.5 V dc |
| Storage temperature range - - - - - | -65°C to +150°C |
| Maximum power dissipation, (P _D) 1/ - - - - - | 60 mW |
| Lead temperature (soldering, 10 seconds) - - - - - | +300°C |
| Thermal resistance, junction-to-case (θ _{JC}) | |
| Cases C and D - - - - - | See MIL-M-38510, appendix C |
| Case 2 - - - - - | 80°C/W 2/ |
| Junction temperature (T _J) - - - - - | +175°C |

1.4 Recommended operating conditions.

| | |
|---|--------------------------------------|
| Supply voltage (V _{CC}) - - - - - | 4.5 V dc minimum to 5.5 V dc maximum |
| Minimum high level input voltage (V _{IH}) - - - - - | 2.0 V dc |
| Maximum low level input voltage (V _{IL}) - - - - - | 0.7 V dc |
| Case operating temperature range (T _C) - - - - - | -55°C to +125°C |

1/ Must withstand the added P_D due to short circuit test (e.g., I_{OS}).

2/ When a thermal resistance for this case is specified in MIL-M-38510, appendix C, that value shall supersede the value specified herein.

| | | | |
|--|-----------|---------------------------------|------------------|
| MILITARY DRAWING DEFENSE ELECTRONICS SUPPLY CENTER DAYTON, OHIO | SIZE A | CODE IDENT. NO. 14933 | DWG NO. 76003 |
| | | REV E | PAGE 2 |

2. APPLICABLE DOCUMENTS

2.1 Government specification and standard. Unless otherwise specified, the following specification and standard, of the issue listed in that issue of the Department of Defense Index of Specifications and Standards specified in the solicitation, form a part of this drawing to the extent specified herein.

SPECIFICATION

MILITARY

MIL-M-38510 - Microcircuits, General Specification for.

STANDARD

MILITARY

MIL-STD-883 - Test Methods and Procedures for Microelectronics.

(Copies of the specification and standard required by manufacturers in connections with specific acquisition functions should be obtained from the contracting activity or as directed by the contracting activity.)

2.2 Order of precedence. In the event of a conflict between the text of this drawing and the references cited herein, the text of this drawing shall take precedence.

3. REQUIREMENTS

3.1 Item requirements. The individual item requirements shall be in accordance with 1.2.1 of MIL-STD-883, "Provisions for the use of MIL-STD-883 in conjunction with compliant non-JAN devices" and as specified herein.

3.2 Design, construction, and physical dimensions. The design, construction, and physical dimensions shall be as specified in MIL-M-38510 and herein.

3.2.1 Terminal connections. The terminal connections shall be as specified on figure 1.

3.2.2 Truth table. The truth table shall be as specified on figure 2.

3.2.3 Logic diagram. The logic diagram shall be as specified on figure 3.

3.2.4 Case outlines. The case outlines shall be in accordance with 1.2.2 herein.

3.3 Electrical performance characteristics. Unless otherwise specified, the electrical performance characteristics are as specified in table I and apply over the full recommended case operating temperature range.

3.4 Marking. Marking shall be in accordance with MIL-STD-883 (see 3.1 herein). The part shall be marked with the part number listed in 1.2 herein. In addition, the manufacturer's part number may also be marked as listed in 6.4 herein.

3.5 Certificate of compliance. A certificate of compliance shall be required from a manufacturer in order to be listed as an approved source of supply in 6.4. The certificate of compliance submitted to DESC-ECS prior to listing as an approved source of supply shall state that the manufacturer's product meets the requirements of MIL-STD-883 (see 3.1 herein) and the requirements herein.

| | | | |
|--|------|-----------------|---------|
| MILITARY DRAWING DEFENSE ELECTRONICS SUPPLY CENTER DAYTON, OHIO | SIZE | CODE IDENT. NO. | DWG NO. |
| | A | 14933 | 76003 |
| | | REV | PAGE |
| | | E | 3 |

DESC FORM 193A
FEB 86

TABLE I. Electrical performance characteristics.

| Test | Symbol | Conditions -55°C < T _C < +125°C unless otherwise specified | Group A subgroups | Limits | | Unit |
|--|-------------------|--|-----------------------------|--------|------|------|
| | | | | Min | Max | |
| High level output voltage | V _{OH} | V _{CC} = 4.5 V; V _{IL} = 0.7 V I _{OH} = -400 μA | 1, 2, 3 | 2.5 | | V |
| Low level output voltage | V _{OL} | V _{CC} = 4.5 V; V _{IH} = 2.0 V I _{OL} = 4 mA | 1, 2, 3 | | 0.4 | V |
| Input clamp voltage | V _{IC} | V _{CC} = 4.5 V; I _{IN} = -18 mA T _C = +25°C | 1 | | -1.5 | V |
| High level input current | I _{IH1} | V _{CC} = 5.5 V; V _{IH} = 2.7 V <u>1/</u> | 1, 2, 3 | | 20 | μA |
| | I _{IH2} | V _{CC} = 5.5 V; V _{IH} = 5.5 V <u>1/</u> | 1, 2, 3 | | 100 | μA |
| Low level input current | I _{IL} | V _{CC} = 5.5 V; V _{IL} = 0.4 V <u>2/</u> | 1, 2, 3 | | -400 | μA |
| Short-circuit output current | I _{OS} | V _{CC} = 5.5 V <u>3/</u> V _{OUT} = 0.0 V | 1, 2, 3 | -15 | -150 | mA |
| Supply current | I _{CC} | V _{CC} = 5.5 V | 1, 2, 3 | | 11 | mA |
| Functional tests | | See 4.3.1c | 7 | | | |
| Propagation delay time, high-to-low level <u>4/</u> A to Q | t _{PHL1} | V _{CC} = 5.0 V R _L = 2 kΩ ±5% R _{ext} = 5 kΩ C _{ext} = 0 | C _L = 15 pF ±10% | 9 | 45 | ns |
| | | | | 10, 11 | 63 | ns |
| | | | C _L = 50 pF ±10% | 9 | 50 | ns |
| | | | | 10, 11 | 70 | ns |

See footnotes at end of table.

| | | | |
|--|-----------|---------------------------------|------------------|
| MILITARY DRAWING DEFENSE ELECTRONICS SUPPLY CENTER DAYTON, OHIO | SIZE A | CODE IDENT. NO. 14933 | DWG NO. 76003 |
| | | REV E | PAGE 4 |

DESC FORM 193A
FEB 86

TABLE I. Electrical performance characteristics - Continued.

| Test | Symbol | Conditions -55°C ≤ T _C ≤ +125°C unless otherwise specified | Group A subgroups | Limits | | Unit | |
|---|-------------------|--|-----------------------------|--------|-----|------|----|
| | | | | Min | Max | | |
| Propagation delay time, low-to-high level <u>4</u> / A to Q | t _{PLH1} | V _{CC} = 5.0 V R _L = 2 kΩ ±5% R _{ext} = 5 kΩ C _{ext} = 0 | C _L = 15 pF ±10% | 9 | | 33 | ns |
| | | | | 10, 11 | | 46 | ns |
| | | | C _L = 50 pF ±10% | 9 | | 38 | ns |
| | | | | 10, 11 | | 53 | ns |
| | | | C _L = 15 pF ±10% | 9 | | 56 | ns |
| | | | | 10, 11 | | 78 | ns |
| Propagation delay time, high-to-low level <u>4</u> / B to Q | t _{PLH2} | V _{CC} = 5.0 V R _L = 2 kΩ ±5% R _{ext} = 5 kΩ C _{ext} = 0 | C _L = 15 pF ±10% | 9 | | 61 | ns |
| | | | | 10, 11 | | 85 | ns |
| | | | C _L = 50 pF ±10% | 9 | | 44 | ns |
| | | | | 10, 11 | | 62 | ns |
| | | | C _L = 15 pF ±10% | 9 | | 49 | ns |
| | | | | 10, 11 | | 69 | ns |
| Propagation delay time, low-to-high level <u>4</u> / B to Q | t _{PLH2} | V _{CC} = 5.0 V R _L = 2 kΩ ±5% R _{ext} = 5 kΩ C _{ext} = 0 | C _L = 15 pF ±10% | 9 | | 27 | ns |
| | | | | 10, 11 | | 38 | ns |
| | | | C _L = 50 pF ±10% | 9 | | 32 | ns |
| | | | | 10, 11 | | 45 | ns |
| | | | C _L = 15 pF ±10% | 9 | | 32 | ns |
| | | | | 10, 11 | | 45 | ns |
| Propagation delay time, high-to-low level <u>4</u> / clear to Q | t _{PHL3} | V _{CC} = 5.0 V R _L = 2 kΩ ±5% R _{ext} = 5 kΩ C _{ext} = 0 | C _L = 15 pF ±10% | 9 | | 27 | ns |
| | | | | 10, 11 | | 38 | ns |
| | | | C _L = 50 pF ±10% | 9 | | 32 | ns |
| | | | | 10, 11 | | 45 | ns |
| | | | C _L = 15 pF ±10% | 9 | | 32 | ns |
| | | | | 10, 11 | | 45 | ns |

See footnotes at end of table.

| | | | |
|--|------|-----------------|---------|
| MILITARY DRAWING DEFENSE ELECTRONICS SUPPLY CENTER DAYTON, OHIO | SIZE | CODE IDENT. NO. | DWG NO. |
| | A | 14933 | 76003 |
| | | REV E | PAGE 5 |

DESC FORM 193A
FEB 86

TABLE I. Electrical performance characteristics - Continued.

| Test | Symbol | Conditions -55°C ≤ T _C ≤ +125°C unless otherwise specified | | Group A subgroups | Limits | | Unit |
|---|----------------------|---|-----------------------------|----------------------|--------|-----|------|
| | | | | | Min | Max | |
| Propagation delay time, low-to-high level <u>4/</u> clear to Q | t _{pLH3} | V _{CC} = 5.0 V R _L = 2 kΩ ±5% R _{ext} = 5 kΩ C _{ext} = 0 | C _L = 15 pF ±10% | 9 | | 45 | ns |
| | | | | 10, 11 | | 63 | ns |
| | | | | 9 | | 50 | ns |
| | | | | 10, 11 | | 70 | ns |
| Propagation delay time, high-to-low level <u>4/</u> Q from A or B | t _{wQ(MIN)} | | C _L = 15 pF ±10% | 9 | | 200 | ns |
| | | | | 10, 11 | | 280 | ns |
| | | | | 9 | | 216 | ns |
| | | | | 10, 11 | | 302 | ns |
| Propagation delay time, low-to-high level <u>4/</u> Q from A or B | t _{wQ} | V _{CC} = 5.0 V R _L = 2 kΩ ±5% R _{ext} = 10 kΩ C _{ext} = 1000 pF | C _L = 15 pF ±10% | 9 | | 5 | μs |
| | | | | 10, 11 | | 7 | μs |

- 1/ All unspecified inputs grounded.
- 2/ All unspecified inputs at 5.5 volts.
- 3/ Not more than one output should be shorted at a time, and the duration of the short circuit condition should not exceed one second.
- 4/ Propagation delay time testing may be performed using either C_L = 15 pF or C_L = 50 pF. However, the manufacturer must certify and guarantee that the microcircuits meet the switching test limits specified for a 50 pF load.

| | | | |
|--|-----------|---------------------------------|------------------|
| MILITARY DRAWING DEFENSE ELECTRONICS SUPPLY CENTER DAYTON, OHIO | SIZE A | CODE IDENT. NO. 14933 | DWG NO. 76003 |
| | | REV E | PAGE 6 |

DESC FORM 193A
FEB 86

3.6 Certificate of conformance. A certificate of conformance as required in MIL-STD-883 (see 3.1 herein) shall be provided with each lot of microcircuits delivered to this drawing.

3.7 Notification of change. Notification of change to DESC-ECS shall be required in accordance with MIL-STD-883 (see 3.1 herein).

3.8 Verification of review. DESC, DESC's agent, and the acquiring activity retain the option to review the manufacturer's facility and applicable required documentation. Offshore documentation shall be made available onshore at the option of the reviewer.

4. QUALITY ASSURANCE PROVISIONS

4.1 Sampling and inspection. Sampling and inspection procedures shall be in accordance with section 4 of MIL-M-38510 to the extent specified in MIL-STD-883 (see 3.1 herein).

4.2 Screening. Screening shall be in accordance with method 5004 of MIL-STD-883, and shall be conducted on all devices prior to quality conformance inspection. The following additional criteria shall apply:

a. Burn-in test (method 1015 of MIL-STD-883).

(1) Test condition A, B, C, or D using the circuit submitted with the certificate of compliance (see 3.5 herein).

(2) $T_A = +125^{\circ}\text{C}$, minimum.

b. Interim and final electrical test parameters shall be as specified in table II herein, except interim electrical parameter tests prior to burn-in are optional at the discretion of the manufacturer.

4.3 Quality conformance inspection. Quality conformance inspection shall be in accordance with method 5005 of MIL-STD-883 including groups A, B, C, and D inspections. The following additional criteria shall apply.

4.3.1 Group A inspection. Group A inspection shall consist of the test subgroups and LTPD values shown in table I of method 5005 of MIL-STD-883, class B, and as follows:

a. Tests shall be as specified in table II herein.

b. Subgroups 4, 5, 6, and 8 in table I, method 5005 of MIL-STD-883 shall be omitted.

c. Subgroup 7 tests sufficient to verify the truth table.

4.3.2 Groups C and D inspections.

a. End-point electrical parameters shall be as specified in table II herein.

b. Steady-state life test (method 1005 of MIL-STD-883) conditions:

(1) Test condition A, B, C, or D using the circuit submitted with the certificate of compliance (see 3.5).

(2) $T_A = +125^{\circ}\text{C}$, minimum.

(3) Test duration: 1,000 hours, except as permitted by appendix B of MIL-M-38510 and method 1005 of MIL-STD-883.

| | | | |
|--|-----------|---------------------------------|------------------|
| MILITARY DRAWING DEFENSE ELECTRONICS SUPPLY CENTER DAYTON, OHIO | SIZE A | CODE IDENT. NO. 14933 | DWG NO. 76003 |
| | | REV E | PAGE 7 |

DESC FORM 193A
FEB 86

Cases C and D

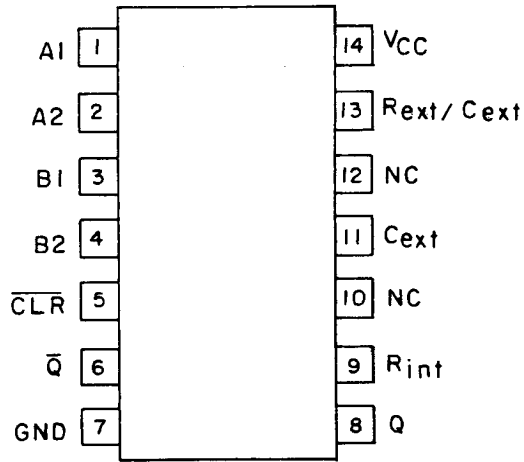

Case 2

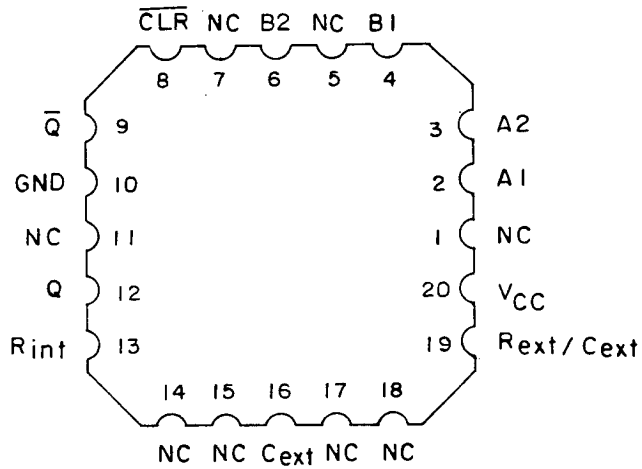



















FIGURE 1. Terminal connections.

| | | | |
|--|-----------|---------------------------------|------------------|
| MILITARY DRAWING DEFENSE ELECTRONICS SUPPLY CENTER DAYTON, OHIO | SIZE A | CODE IDENT. NO. 14933 | DWG NO. 76003 |
| | | REV E | PAGE 8 |

DESC FORM 193A
FEB 86

| Inputs | | | | | Outputs | |
|--------|----|----|----|----|--|--|
| Clear | A1 | A2 | B1 | B2 | Q | \bar{Q} |
| L | X | X | X | X | L | H |
| X | H | H | X | X | L | H |
| X | X | X | L | X | L | H |
| X | X | X | X | L | L | H |
| H | L | X | ↑ | H |  |  |
| H | L | X | H | ↑ |  |  |
| H | X | L | ↑ | H |  |  |
| H | X | L | H | ↑ |  |  |
| H | H | ↓ | H | H |  |  |
| H | ↓ | ↓ | H | H |  |  |
| H | ↓ | H | H | H |  |  |
| ↑ | L | X | H | H |  |  |
| ↑ | X | L | H | H |  |  |

OUTPUTS
SEE NOTE 1



1. These lines of the functional tables assume that the indicated steady-state conditions at the A and B inputs have been set long enough to complete any pulse started before the setup.
2. H = high level (steady state), L = low level (steady state), ↑ = transition from low to high level, ↓ = transition from high to low level,  = one high-level pulse,  = one low-level pulse, X = irrelevant (any input, including transitions).
3. To use the internal timing resistor of LS122, connect R_{int} to V_{CC} .
4. An external timing capacitor may be connected between C_{ext} and R_{ext}/C_{ext} (positive).
5. For accurate repeatable pulse widths, connect an external resistor between R_{ext}/C_{ext} and V_{CC} with R_{int} open circuited.
6. To obtain variable pulse widths, connect external variable resistance between R_{int} or R_{ext}/C_{ext} and V_{CC} .

FIGURE 2. Truth table.

| | | | |
|--|-----------|---------------------------------|------------------|
| MILITARY DRAWING DEFENSE ELECTRONICS SUPPLY CENTER DAYTON, OHIO | SIZE A | CODE IDENT. NO. 14933 | DWG NO. 76003 |
| | | REV E | PAGE 9 |

DESC FORM 193A
FEB 86

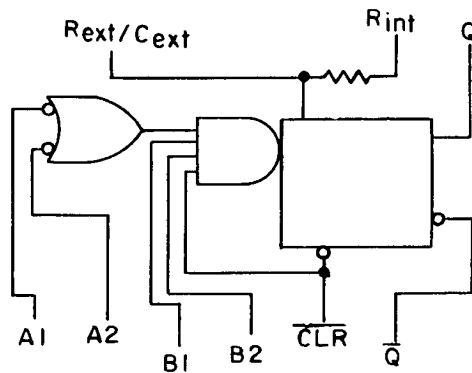

FIGURE 3. Logic diagram.

| | | | |
|--|-----------|---------------------------------|------------------|
| MILITARY DRAWING DEFENSE ELECTRONICS SUPPLY CENTER DAYTON, OHIO | SIZE A | CODE IDENT. NO. 14933 | DWG NO. 76003 |
| | | REV E | PAGE 10 |

DESC FORM 193A
 FEB 86

TABLE II. Electrical test requirements.

| MIL-STD-883 test requirements | Subgroups (per method 5005, table 1) |
|--|--|
| Interim electrical parameters (method 5004) | --- |
| Final electrical test parameters (method 5004) | 1*, 2, 3, 9 |
| Group A test requirements (method 5005) | 1, 2, 3, 7, 9, 10, 11** |
| Groups C and D end-point electrical parameters (method 5005) | 1, 2, 3 |

* PDA applies to subgroup 1.

** Subgroups 10 and 11, if not tested, shall be guaranteed to the specified limits in table I.

5. PACKAGING

5.1 Packaging requirements. The requirements for packaging shall be in accordance with MIL-M-38510.

6. NOTES

6.1 Intended use. Microcircuits conforming to this drawing are intended for use when military specifications do not exist and qualified military devices that will perform the required function are not available for OEM application. When a military specification exists and the product covered by this drawing has been qualified for listing on QPL-38510, the device specified herein will be inactivated and will not be used for new design. The QPL-38510 product shall be the preferred item for all applications.

6.2 Replaceability. Replaceability is determined as follows:

- a. Microcircuits covered by this drawing will replace the same generic device covered by a contractor-prepared specification or drawing.
- b. When a QPL source is established, the part numbered device specified in this drawing will be replaced by the microcircuit identified as part number M38510/31403B--.

6.3 Comments. Comments on this drawing should be directed to DESC-ECS, Dayton, OH 45444, or telephone 513-296-5375.

| | | | |
|--|-----------|---------------------------------|------------------|
| MILITARY DRAWING DEFENSE ELECTRONICS SUPPLY CENTER DAYTON, OHIO | SIZE A | CODE IDENT. NO. 14933 | DWG NO. 76003 |
| | | REV E | PAGE 11 |

DESC FORM 193A
FEB 86

6.4 Approved sources of supply. Approved sources of supply are listed herein. Additional sources will be added as they become available. The vendors listed herein have agreed to this drawing and a certificate of compliance (see 3.5 herein) has been submitted to DESC-ECS.

| Military drawing part number | Vendor CAGE number | Similar <u>1/</u> vendor type | Replacement military specification part number |
|------------------------------|--------------------|--------------------------------|--|
| 7600301CX <u>2/</u> | 01295 04713 | SNJ54LS122J 54LS122/BCBJC | M38510/31403BCX |
| 7600301DX <u>2/</u> | 01295 04713 | SNJ54LS122W 54LS122/BDBJC | M38510/31403BDX |
| 76003012X <u>2/</u> | 01295 04713 | SNJ54LS122FK 54LS122M/B2BJC | M38510/31403B2X |

1/ **CAUTION.** Do not use this number for item acquisition. Items acquired to the similar vendor type only may not satisfy the performance requirements of this drawing.

2/ Inactive for new design. Use QPL-38510 product.

| <u>Vendor CAGE number</u> | <u>Vendor name and address</u> |
|---------------------------|--|
| 01295 | Texas Instruments, Inc. P. O. Box 6448 Midland, TX 79701 |
| 04713 | Motorola, Inc. 7402 South Price Road Tempe, AZ 85283 |

| | | | |
|--|-----------|---------------------------------|------------------|
| MILITARY DRAWING DEFENSE ELECTRONICS SUPPLY CENTER DAYTON, OHIO | SIZE A | CODE IDENT. NO. 14933 | DWG NO. 76003 |
| | | REV E | PAGE 12 |

DESC FORM 193A
FEB 86

012794 - - -