

Description

The MIM-5383K2 is miniaturized infrared receivers for remote control and other applications requiring improved ambient light rejection. The separate PIN diode and preamplifier IC are assembled on a single leadframe. The epoxy package contains a special IR filter. This module has excellent performance even in disturbed ambient light applications and provides protection against uncontrolled output pulses.



Features

1. Photo detector and preamplifier in one package
2. Internal filter for PCM frequency
3. High immunity against ambient light
4. Enhanced disturbance suppression
5. 5.0-Volt supply voltage; low power consumption
6. TTL and CMOS compatibility

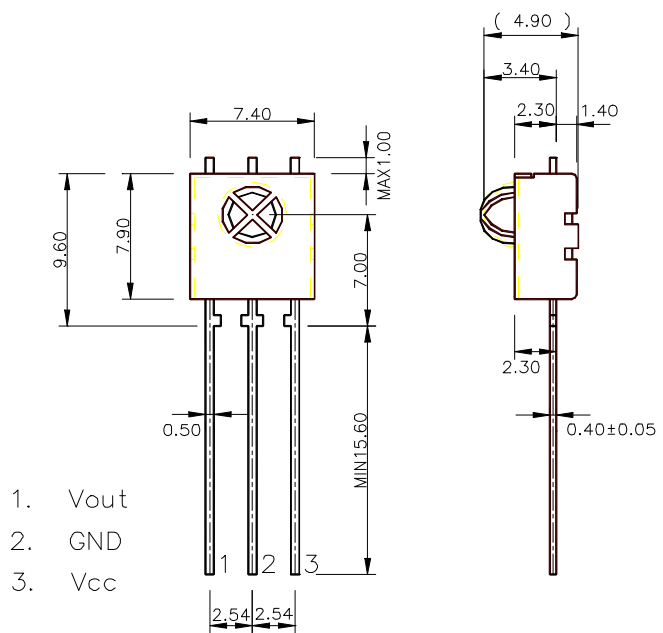

Ps 1. TOLERANCE : ±0.3 UNLESS OTHERWISE SPECIFIED

Unit : mm

BLOCK DIAGRAM

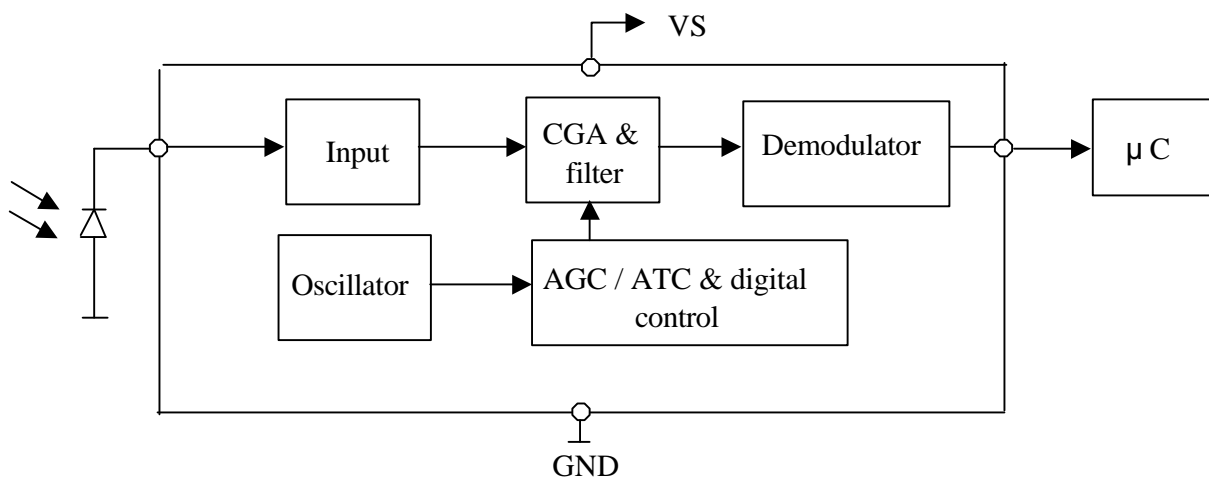

Absolute Maximum Ratings

@ Ta=25

Item	Symbol	Ratings	Unit	Remark
Supply voltage	V_{CC}	6.0	V	
Operating temperature	T_{opr}	-10 ~ + 75		
Storage temperature	T_{stg}	-10 ~ + 75		
Soldering temperature	T_{sd}	260		t 10 s, 1mm from case

Electro-optical characteristics (Vcc=5.0V)

($T_a=25^\circ C$)

Parameter	Symbol	Min.	Typ.	Max.	Unit	Remarks
Current consumption	I_{cc}		1.4	2.0	mA	Under no signal
Response wavelength	ρ		940		nm	
Tuning frequency	f_0		37.9		KHz	
Output form	----- active low output -----					
H level output voltage	V_{0h}	4.2			V	
L level output voltage	V_{0l}			0.5	V	
H level output pulse width	T_{wh}	400		800	μs	
L level output pulse width	T_{wl}	400		800	μs	
Distance between emitter & detector	L	10.0			m	NOTE 1
Half angle			± 45		deg	Horizontal direction

Test Method

A. Standard Transmitter

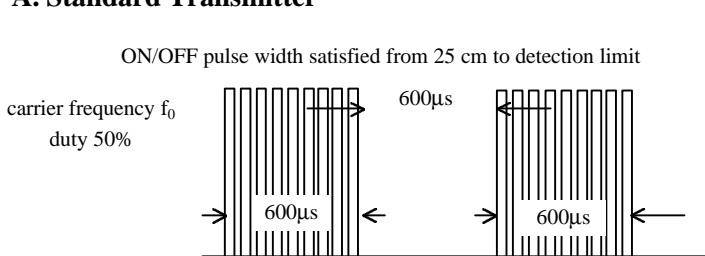

Fig 1. Burst Wave

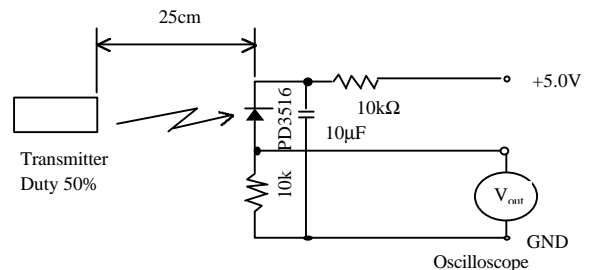
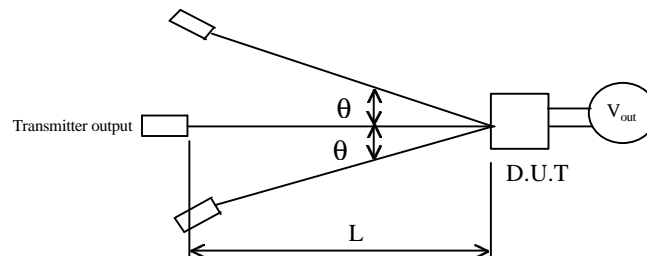
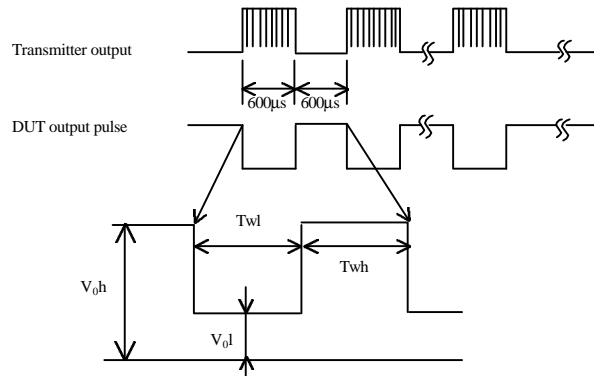

Fig 2. Standard Transmitter Measurement circuit

B. Detection Length Test



C . Pulse Width Test



Application Circuit

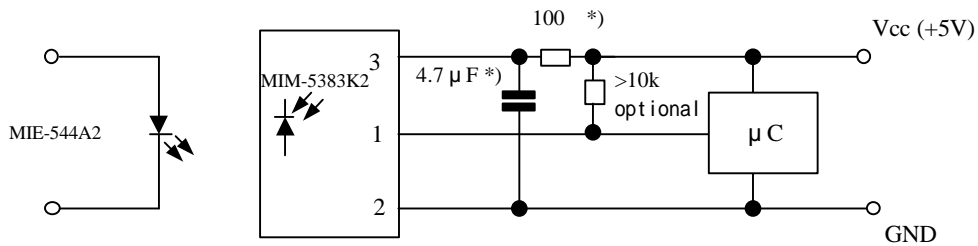

*) recommended to suppress power supply disturbances

CHARACTERISTIC CURVES (T_A=25 °C)

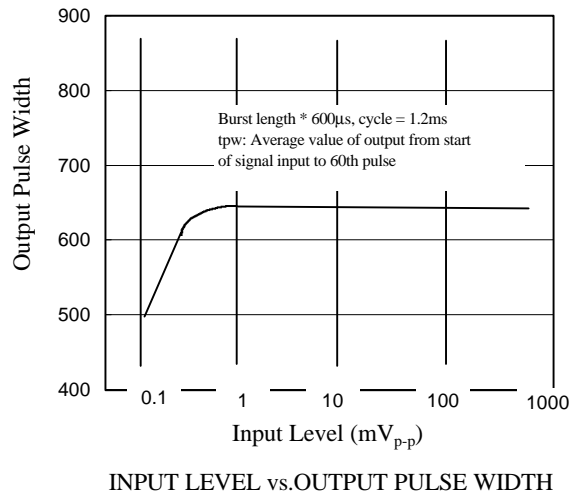
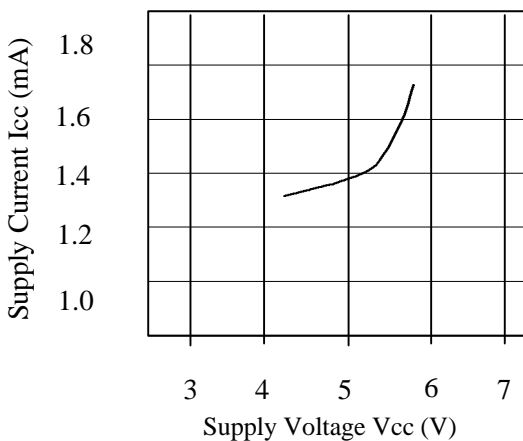

NOTE 1. Distance between emitter & detector specifies maximum distance that output wave form satisfies the standard under the conditions below against the standard transmitter.

- (1) Measuring placeIndoor without extreme reflection of light.
- (2) Ambient light source... Detecting surface illumination shall be 200±50Lux under ordinary hite fluorescence lamp of no high frequency lighting.
- (3) Standard transmitter ...Burst wave indicated in Fig 1. of standard transmitter shall be arranged to 50mVp-p under the measuring circuit specified in Fig 2.

Reliability

Test item	Test condition	Standard
High temperature	Ta=+60 Vcc=5.0 V t=240H	Note 2.
High temp. & high humi.	Ta=+40 90%RH Vcc=5.0V t=240H	Note 2.
Low temperature	Ta= -10 Vcc=5.0V t=240H	Note 2.
Heat cycle	-20 (0.5H) ~ +75 (0.5H) 20cycle	Note 2.
Dropping	Test devices shall be dropped 3 times naturally onto hard wooden board from a 75cm height position.	Note 3.

NOTE 2. (electro-optical characteristics) shall be satisfied after leaving 2 hours in the normal temperature .

NOTE 3. (electro-optical characteristics) shall be satisfied and no conoid deforms and destructions of appearance .(excepting deforms of terminals)

Inspection standard

- 1.Among electrical characteristics , total number shall be inspected on items blow.
 - 1-1 front distance between emitter & detector
 - 1-2 Current consumption
 - 1-3 H level output voltage
 - 1-4 L level output voltage
- 2.Items except above mentioned are not inspected particularly , but shall fully satisfy

CAUTION (When use and storage of this device)

- 1.Store and use where there is no force causing transformation or change in quality .
- 2.Store and use where there is no corrosive gas or sea(salt) breeze .
- 3.Store and use where there is no extreme humidity .
- 4.Solder the lead-pin within the condition of ratings. After soldering do not add extra force .
- 5.Do not wash this device . Wipe the stains of diode side with a soft cloth. You can use the solvent , ethylalcohol or methylalcohol or isopropylene only .
- 6.To prevent static electricity damage to the Pre-AMP make sure that the human body , the soldering iron is connected to ground before using .
- 7.Put decoupling device between Vcc and GND for reduce the noise from power supply line .
- 8.The performance of remote-control system depends on environments condition and ability of periferal parts. Customer should evaluate the performance as total system in those conditions after system up with components such as commander , micon and this receiver module .

Guarantee period and scope

- 1.Guarantee period

One year after delivery to desired place .
- 2.Guarantee scope

A re-delivery of goods will be carried out if the cause of malfunction lies in our device .However no responsibilities be taken for the inconveniences caused by the malfunction of our devices .

Others

- 1.This device is not design to endure radiative rays and heavily charged particles .
- 2.In case where any trouble or questions arise,both parties agres to make full discussion covering the said problem .