

REVISIONS

LTR	DESCRIPTION	DATE (YR-MO-DA)	APPROVED

REV																							
SHEET																							
REV																							
SHEET	15	16	17																				
REV STATUS OF SHEETS				REV																			
				SHEET	1	2	3	4	5	6	7	8	9	10	11	12	13	14					
PMIC N/A				PREPARED BY RAJ PITHADIA						DEFENSE ELECTRONICS SUPPLY CENTER DAYTON, OHIO 45444													
<b>STANDARDIZED MILITARY DRAWING</b>  THIS DRAWING IS AVAILABLE FOR USE BY ALL DEPARTMENTS AND AGENCIES OF THE DEPARTMENT OF DEFENSE  AMSC N/A				CHECKED BY SANDRA ROONEY						MICROCIRCUIT, MEMORY, DIGITAL, CMOS UV ERASABLE PROGRAMMABLE LOGIC ARRAY, MONOLITHIC SILICON													
				APPROVED BY MICHAEL FRYE																			
				DRAWING APPROVAL DATE 94-03-01						SIZE <b>A</b>	CAGE CODE <b>67268</b>	<b>5962-90989</b>											
				REVISION LEVEL						SHEET 1 OF 17													

DESC FORM 193  
JUL 91

5962-E125-94

DISTRIBUTION STATEMENT A. Approved for public release; distribution is unlimited.

74E ■ 9004708 0000264 493 ■

1. SCOPE

1.1 Scope. This drawing forms a part of a one part - one part number documentation system (see 6.6 herein). Two product assurance classes consisting of military high reliability (device classes Q and M) and space application (device class V), and a choice of case outlines and lead finishes are available and are reflected in the Part or Identifying Number (PIN). Device class M microcircuits represent non-JAN class B microcircuits in accordance with 1.2.1 of MIL-STD-883, "Provisions for the use of MIL-STD-883 in conjunction with compliant non-JAN devices". When available, a choice of Radiation Hardness Assurance (RHA) levels are reflected in the PIN.

1.2 PIN. The PIN shall be as shown in the following example:

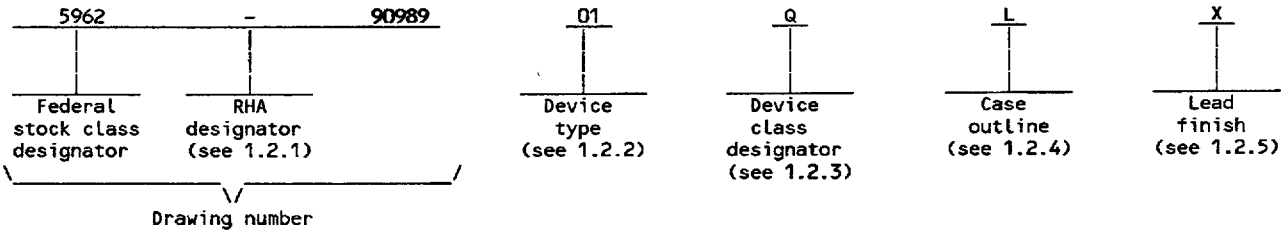

1.2.1 RHA designator. Device class M RHA marked devices shall meet the MIL-I-38535 appendix A specified RHA levels and shall be marked with the appropriate RHA designator. Device classes Q and V RHA marked devices shall meet the MIL-I-38535 specified RHA levels and shall be marked with the appropriate RHA designator. A dash (-) indicates a non-RHA device.

1.2.2 Device type(s). The device type(s) shall identify the circuit function as follows:

Device type	Generic number <sup>1/</sup>	Circuit function	t <sub>PD</sub>
01		Asynchronous EPLD	35 ns
02		Asynchronous EPLD	25 ns
03		Asynchronous EPLD	20 ns

1.2.3 Device class designator. The device class designator shall be a single letter identifying the product assurance level as follows:

Device class	Device requirements documentation
M	Vendor self-certification to the requirements for non-JAN class B microcircuits in accordance with 1.2.1 of MIL-STD-883
Q or V	Certification and qualification to MIL-I-38535

1.2.4 Case outline(s). The case outline(s) shall be as designated in MIL-STD-1835 and as follows:

Outline letter	Descriptive designator	Terminals	Package style
L	GDIP3-T24 or CDIP4-T24	24	Dual-in-line <sup>2/</sup>
3	CQCC1-N28	28	Square leadless chip carrier <sup>2/</sup>

1.2.5 Lead finish. The lead finish shall be as specified in MIL-STD-883 (see 3.1 herein) for class M or MIL-I-38535 for classes Q and V. Finish letter "X" shall not be marked on the microcircuit or its packaging. The "X" designation is for use in specifications when lead finishes A, B, and C are considered acceptable and interchangeable without preference.

<sup>1/</sup> Generic numbers are listed on the Standardized Military Drawing Source Approval Bulletin at the end of this document and will also be listed in MIL-BUL-103.  
<sup>2/</sup> Lid shall be transparent to permit ultraviolet light erasure.

STANDARDIZED MILITARY DRAWING DEFENSE ELECTRONICS SUPPLY CENTER DAYTON, OHIO 45444	SIZE <b>A</b>		5962-90989
		REVISION LEVEL	SHEET 2

DESC FORM 193A  
 JUL 91

74E ■ 9004708 0000265 32T ■

1.3 Absolute maximum ratings. 3/

Supply voltage to ground potential - - - - -	-0.5 V dc to +7.0 V dc
DC voltage applied to outputs in high Z state -	-0.5 V dc to +7.0 V dc
DC input voltage - - - - -	-3.0 V dc to +7.0 V dc
Maximum power dissipation ( $P_D$ ) 4/ - - - - -	1.0 W
Lead temperature (soldering, 10 seconds) - - - -	+260°C
Thermal resistance, junction-to-case ( $\theta_{JC}$ ): - -	See MIL-STD-1835
Junction temperature ( $T_J$ ) - - - - -	+175°C
Storage temperature range - - - - -	-65°C to +150°C
Temperature under bias - - - - -	-55°C to +125°C
Output current into outputs (low) - - - - -	-16 mA
Data retention - - - - -	10 years (minimum)
Endurance - - - - -	25 erase/write cycles (minimum)

1.4 Recommended operating conditions.

Supply voltage ( $V_{CC}$ ) - - - - -	+4.5 V dc to +5.5 V dc
Ground voltage (GND) - - - - -	0 V dc
Input high voltage ( $V_{IH}$ ) - - - - -	2.0 V dc minimum
Input low voltage ( $V_{IL}$ ) - - - - -	0.8 V dc maximum
Case operating temperature range ( $T_C$ ) - - - -	-55°C to +125°C

1.5 Digital logic testing for device classes Q and V.

Fault coverage measurement of manufacturing logic tests (MIL-STD-883, test method 5012) . . . . . 5/ percent

2. APPLICABLE DOCUMENTS

2.1 Government specification, standards, bulletin, and handbook. Unless otherwise specified, the following specification, standards, bulletin, and handbook of the issue listed in that issue of the Department of Defense Index of Specifications and Standards specified in the solicitation, form a part of this drawing to the extent specified herein.

SPECIFICATION

MILITARY

MIL-I-38535 - Integrated Circuits, Manufacturing, General Specification for.

STANDARDS

MILITARY

MIL-STD-883 - Test Methods and Procedures for Microelectronics.  
 MIL-STD-973 - Configuration Management.  
 MIL-STD-1835 - Microcircuit Case Outlines.

BULLETIN

MILITARY

MIL-BUL-103 - List of Standardized Military Drawings (SMD's).

HANDBOOK

MILITARY

MIL-HDBK-780 - Standardized Military Drawings.

3/ Stresses above the absolute maximum rating may cause permanent damage to the device. Extended operation at the maximum levels may degrade performance and affect reliability.

4/ Must withstand the added  $P_D$  due to short circuit test; e.g.,  $I_{OS}$ .

5/ Values will be added when they become available.

STANDARDIZED MILITARY DRAWING DEFENSE ELECTRONICS SUPPLY CENTER DAYTON, OHIO 45444	SIZE <b>A</b>		5962-90989
		REVISION LEVEL	SHEET 3

DESC FORM 193A  
 JUL 91

74E ■ 9004708 0000266 266 ■

(Copies of the specification, standards, bulletin, and handbook required by manufacturers in connection with specific acquisition functions should be obtained from the contracting activity or as directed by the contracting activity.)

2.2 Non-Government publications. The following document(s) form a part of this document to the extent specified herein. Unless otherwise specified, the issues of the documents which are DoD adopted are those listed in the issue of the DODISS cited in the solicitation. Unless otherwise specified, the issues of documents not listed in the DODISS are the issues of the documents cited in the solicitation.

**AMERICAN SOCIETY FOR TESTING AND MATERIALS (ASTM)**

ASTM Standard F1192-88 - Standard Guide for the Measurement of Single Event Phenomena from Heavy Ion Irradiation of Semiconductor Devices.

(Applications for copies of ASTM publications should be addressed to the American Society for Testing and Materials, 1916 Race Street, Philadelphia, PA 19103.)

**ELECTRONICS INDUSTRIES ASSOCIATION (EIA)**

JEDEC Standard No. 17 - A Standardized Test Procedure for the Characterization of Latch-up in CMOS Integrated Circuits.

(Applications for copies should be addressed to the Electronics Industries Association, 2001 Pennsylvania Street, N.W., Washington, DC 20006.)

(Non-Government standards and other publications are normally available from the organizations that prepare or distribute the documents. These documents also may be available in or through libraries or other informational services.)

2.3 Order of precedence. In the event of a conflict between the text of this drawing and the references cited herein, the text of this drawing shall take precedence.

**3. REQUIREMENTS**

3.1 Item requirements. The individual item requirements for device class M shall be in accordance with 1.2.1 of MIL-STD-883, "Provisions for the use of MIL-STD-883 in conjunction with compliant non-JAN devices" and as specified herein. The individual item requirements for device classes Q and V shall be in accordance with MIL-I-38535, the device manufacturer's Quality Management (QM) plan, and as specified herein.

3.2 Design, construction, and physical dimensions. The design, construction, and physical dimensions shall be as specified in MIL-STD-883 (see 3.1 herein) for device class M and MIL-I-38535 for device classes Q and V and herein.

3.2.1 Case outline(s). The case outline(s) shall be in accordance with 1.2.4 herein.

3.2.2 Terminal connections. The terminal connections shall be as specified on figure 1.

3.2.3 Truth table(s). The truth table shall be as specified on figure 2.

3.2.3.1 Unprogrammed devices. The truth table for unprogrammed devices for contracts involving no altered item drawing shall be as specified on figure 2. When required in screening (see 4.2 herein) or quality conformance inspection group A, C, D, or E (see 4.4 herein), the devices shall be programmed by the manufacturer prior to test with a minimum of 50 percent of the total number of gates programmed or to any altered item drawing pattern which includes at least 25 percent of the total number of gates programmed.

3.2.3.2 Programmed devices. The requirements for supplying programmed devices shall be as specified by an attached altered item drawing.

3.2.4 Radiation exposure circuit. The radiation exposure circuit will be provided when RHA product becomes available.

3.3 Electrical performance characteristics and postirradiation parameter limits. Unless otherwise specified herein, the electrical performance characteristics and postirradiation parameter limits are as specified in table I and shall apply over the full case operating temperature range.

3.4 Electrical test requirements. The electrical test requirements shall be the subgroups specified in table IIA. The electrical tests for each subgroup are defined in table I.

<b>STANDARDIZED MILITARY DRAWING DEFENSE ELECTRONICS SUPPLY CENTER DAYTON, OHIO 45444</b>	<b>SIZE A</b>		<b>5962-90989</b>
		<b>REVISION LEVEL</b>	<b>SHEET 4</b>

DESC FORM 193A

JUL 91

74E ■ 9004708 0000267 1T2 ■

3.5 Marking. The part shall be marked with the PIN listed in 1.2 herein. Marking for device class M shall be in accordance with MIL-STD-883 (see 3.1 herein). In addition, the manufacturer's PIN may also be marked as listed in MIL-BUL-103. Marking for device classes Q and V shall be in accordance with MIL-I-38535.

3.5.1 Certification/compliance mark. The compliance mark for device class M shall be a "C" as required in MIL-STD-883 (see 3.1 herein). The certification mark for device classes Q and V shall be a "QML" or "Q" as required in MIL-I-38535.

3.6 Processing EPLDS. All testing requirements and quality assurance provisions herein shall be satisfied by the manufacturer prior to delivery.

3.6.1 Erasure of EPLDS. When specified, devices shall be erased in accordance with the procedures and characteristics specified in 4.6.

3.6.2 Programmability of EPLDS. When specified, devices shall be programmed to the specified pattern using the procedures and characteristics specified in 4.7.

3.6.3 Verification of erasure or programmed EPLDS. When specified, devices shall be verified as either programmed to the specified pattern or erased. As a minimum, verification shall consist of performing a functional test (subgroup 7) to verify that all bits are in the proper state. Any bit that does not verify to be in the proper state shall constitute a device failure, and shall be removed from the lot.

3.7 Processing options. Since the device is capable of being programmed by either the manufacturer or the user to result in a wide variety of configurations; two processing options are provided for selection in the contract.

3.7.1 Unprogrammed device delivered to the user. All testing shall be verified through group A testing as defined in 3.2.3.1 and table IIA. It is recommended that users perform subgroups 7 and 9 after programming to verify the specific program configuration.

3.7.2 Manufacturer programmed device delivered to the user. All testing requirements and quality assurance provisions herein, including the requirements of the altered item drawing, shall be satisfied by the manufacturer prior to delivery.

3.8 Certificate of compliance. For device class M, a certificate of compliance shall be required from a manufacturer in order to be listed as an approved source of supply in MIL-BUL-103 (see 6.7.2 herein). For device classes Q and V, a certificate of compliance shall be required from a QML-38535 listed manufacturer in order to supply to the requirements of this drawing (see 6.7.1 herein). The certificate of compliance submitted to DESC-EC prior to listing as an approved source of supply for this drawing shall affirm that the manufacturer's product meets, for device class M, the requirements of MIL-STD-883 (see 3.1 herein), or for device classes Q and V, the requirements of MIL-I-38535 and the requirements herein.

3.9 Certificate of conformance. A certificate of conformance as required for device class M in MIL-STD-883 (see 3.1 herein) or for device classes Q and V in MIL-I-38535 shall be provided with each lot of microcircuits delivered to this drawing.

3.10 Notification of change for device class M. For device class M, notification to DESC-EC of change of product (see 6.2 herein) involving devices acquired to this drawing is required for any change as defined in MIL-STD-973.

3.11 Verification and review for device class M. For device class M, DESC, DESC's agent, and the acquiring activity retain the option to review the manufacturer's facility and applicable required documentation. Offshore documentation shall be made available onshore at the option of the reviewer.

3.12 Microcircuit group assignment for device class M. Device class M devices covered by this drawing shall be in microcircuit group number 42 (see MIL-I-38535, appendix A).

3.13 Endurance. A reprogrammability test shall be completed as part of the vendor's reliability monitor. This reprogrammability test shall be done only for initial characterization and after any design or process changes which may affect the reprogrammability of the device. The methods and procedures may be vendor specific, but will guarantee the number of program/erase endurance cycles listed in section 1.3 herein. The vendors procedure shall be under document control and shall be made available upon request.

3.14 Data retention. A data retention stress test shall be completed as part of the vendor's reliability process. This test shall be done initially and after any design or process change which may affect data retention. The methods and procedures may be vendor specific, but will guarantee the number of years listed in section 1.3 herein. The vendors procedure shall be under document control and shall be made available upon request. Data retention capability shall be guaranteed over the full military temperature range.

<b>STANDARDIZED MILITARY DRAWING DEFENSE ELECTRONICS SUPPLY CENTER DAYTON, OHIO 45444</b>	<b>SIZE A</b>		<b>5962-90989</b>
		<b>REVISION LEVEL</b>	<b>SHEET 5</b>

DESC FORM 193A  
JUL 91

74E ■ 9004708 0000268 039 ■

TABLE I. Electrical performance characteristics.

Test	Symbol	Conditions -55°C ≤ T <sub>C</sub> ≤ +125°C 4.5 V ≤ V <sub>CC</sub> ≤ 5.5 V unless otherwise specified	Group A subgroups	Device types	Limits		Unit
					Min	Max	
Output high voltage	V <sub>OH</sub>	V <sub>CC</sub> = 4.5 V, I <sub>OH</sub> = -2.0 mA, V <sub>IN</sub> = V <sub>IH</sub> , V <sub>IL</sub>	1, 2, 3	A11	2.4		V
Output low voltage	V <sub>OL</sub>	V <sub>CC</sub> = 4.5 V, I <sub>OL</sub> = 8.0 mA, V <sub>IN</sub> = V <sub>IH</sub> , V <sub>IL</sub>	1, 2, 3	A11		0.5	V
Input high voltage <u>1/</u>	V <sub>IH</sub>		1, 2, 3	A11	2.0		V
Input low voltage <u>1/</u>	V <sub>IL</sub>		1, 2, 3	A11		0.8	V
Input leakage current	I <sub>IX</sub>	V <sub>IN</sub> = 5.5 V to GND	1, 2, 3	A11	-10	10	μA
Output leakage current	I <sub>OZ</sub>	V <sub>CC</sub> = 5.5 V, V <sub>OUT</sub> = 5.5 V and GND	1, 2, 3	A11	-40	40	μA
Output short circuit current <u>2/ 3/</u>	I <sub>OS</sub>	V <sub>CC</sub> = 5.5 V, V <sub>OUT</sub> = 0.5 V	1, 2, 3	A11	-30	-90	mA
Standby power supply current	I <sub>CC1</sub>	V <sub>CC</sub> = 5.5 V, I <sub>OUT</sub> = 0 mA, V <sub>IN</sub> = GND	1, 2, 3	A11		80	mA
Power supply current at frequency <u>3/</u>	I <sub>CC2</sub>	V <sub>CC</sub> = 5.5 V, I <sub>OUT</sub> = 0 mA, V <sub>IN</sub> = 0 to 3 V, f = f <sub>MAX</sub>	1, 2, 3	A11		85	mA
Input capacitance <u>3/</u>	C <sub>IN</sub>	V <sub>CC</sub> = 5.0 V T <sub>A</sub> = +25°C, f = 1 MHz (See 4.4.1e)	4	A11		10	pF
Output capacitance <u>3/</u>	C <sub>OUT</sub>		4	A11		10	pF
Functional tests		See 4.4.1c	7, 8A, 8B	A11			
Input or feedback to nonregistered output <u>4/</u>	t <sub>PD</sub>		9, 10, 11	01		35	ns
				02		25	
				03		20	
Input to output enable <u>3/ 5/</u>	t <sub>EA</sub>		9, 10, 11	01		35	ns
				02		30	
				03		20	

See footnotes at end of table.

STANDARDIZED MILITARY DRAWING DEFENSE ELECTRONICS SUPPLY CENTER DAYTON, OHIO 45444	SIZE <b>A</b>		5962-90989
		REVISION LEVEL	SHEET 6

DESC FORM 193A  
JUL 91

74E ■ 9004708 0000269 T75 ■

TABLE I. Electrical performance characteristics - Continued.

Test	Symbol	Conditions -55°C ≤ T <sub>C</sub> ≤ +125°C 4.5 V ≤ V <sub>CC</sub> ≤ 5.5 V unless otherwise specified	Group A subgroups	Device types	Limits		Unit
					Min	Max	
Input to output disable <u>3/ 5/</u>	t <sub>ER</sub>		9, 10, 11	01		35	ns
				02		30	
				03		20	
$\overline{\text{OE}}$ to output enable <u>5/</u>	t <sub>PZX</sub>		9, 10, 11	01		25	ns
				02		20	
				03		15	
$\overline{\text{OE}}$ to output disable <u>3/ 5/</u>	t <sub>PXZ</sub>		9, 10, 11	01		25	ns
				02		20	
				03		15	
Clock to output <u>4/</u>	t <sub>CO</sub>		9, 10, 11	01		35	ns
				02		25	
				03		20	
Input or feedback setup time <u>4/</u>	t <sub>SU</sub>		9, 10, 11	01	20		ns
				02	15		
				03	10		
Hold time <u>4/</u>	t <sub>H</sub>		9, 10, 11	01,02	5		ns
				03	3		
Clock period (t <sub>SU</sub> + t <sub>CO</sub> ) <u>4/</u>	t <sub>P</sub>		9, 10, 11	01	55		ns
				02	40		
				03	30		
Clock width high <u>3/ 4/</u>	t <sub>WH</sub>		9, 10, 11	01	25		ns
				02	18		
				03	12		
Clock width low <u>3/ 4/</u>	t <sub>WL</sub>		9, 10, 11	01	25		ns
				02	18		
				03	12		

See footnotes at end of table.

STANDARDIZED MILITARY DRAWING DEFENSE ELECTRONICS SUPPLY CENTER DAYTON, OHIO 45444	SIZE <b>A</b>		5962-90989
		REVISION LEVEL	SHEET 7

DESC FORM 193A  
JUL 91

74E ■ 9004708 0000270 797 ■

TABLE I. Electrical performance characteristics - Continued.

Test	Symbol	Conditions -55°C ≤ T <sub>C</sub> ≤ +125°C 4.5 V ≤ V <sub>CC</sub> ≤ 5.5 V unless otherwise specified	Group A subgroups	Device types	Limits		Unit
					Min	Max	
Maximum frequency (1/(t <sub>p</sub> )) 3/ 4/	f <sub>MAX</sub>		9, 10, 11	01	18.1		MHz
				02	25.0		
				03	33.3		
Input of asynchronous set to registered output 3/ 4/	t <sub>S</sub>		9, 10, 11	01		40	ns
				02		25	
				03		20	
Input of asynchronous reset to registered output 3/ 4/	t <sub>R</sub>		9, 10, 11	01		40	ns
				02		25	
				03		20	
Asynchronous reset width 3/ 4/	t <sub>ARW</sub>		9, 10, 11	01,02	25		ns
				03	20		
Asynchronous set width 3/ 4/	t <sub>ASW</sub>		9, 10, 11	01,02	25		ns
				03	20		
Asynchronous set/reset recovery time 3/ 4/	t <sub>AR</sub>		9, 10, 11	01	20		ns
				02	15		
				03	12		
Preload pulse width 3/ 4/	t <sub>WP</sub>		9, 10, 11	ALL	15		ns
Preload setup time 3/ 4/	t <sub>SUP</sub>		9, 10, 11	ALL	15		ns
Preload hold time 3/ 4/	t <sub>HP</sub>		9, 10, 11	ALL	15		ns

- 1/ These are absolute values with respect to device ground and all overshoots due to system or tester noise are included.
- 2/ For test purposes, not more than one output at a time should be shorted. Short circuit test duration should not exceed 1 second. V<sub>OUT</sub> = 0.5 V has been chosen to avoid test problems caused by tester ground degradation.
- 3/ Tested initially and after any design or process changes that affect that parameter, and therefore shall be guaranteed to the limits specified in table I.
- 4/ AC tests are performed with input rise and fall times of 5 ns or less, timing reference levels of 1.5 V, input pulse levels of 0 to 3.0 V, and the output load on figure 3, circuit A. See figure 4 for waveforms.
- 5/ Measured using the test load on figure 3, circuit B. See figure 4 for waveforms.

STANDARDIZED MILITARY DRAWING DEFENSE ELECTRONICS SUPPLY CENTER DAYTON, OHIO 45444	SIZE <b>A</b>		5962-90989
		REVISION LEVEL	SHEET 8

DESC FORM 193A  
JUL 91

74E ■ 9004708 0000271 623 ■



**4. QUALITY ASSURANCE PROVISIONS**

**4.1 Sampling and inspection.** For device class M, sampling and inspection procedures shall be in accordance with MIL-STD-883 (see 3.1 herein). For device classes Q and V, sampling and inspection procedures shall be in accordance with MIL-I-38535 and the device manufacturer's QM plan.

**4.2 Screening.** For device class M, screening shall be in accordance with method 5004 of MIL-STD-883, and shall be conducted on all devices prior to quality conformance inspection. For device classes Q and V, screening shall be in accordance with MIL-I-38535, and shall be conducted on all devices prior to qualification and technology conformance inspection.

**4.2.1 Additional criteria for device class M.**

- a. Delete the sequence specified as initial (preburn-in) electrical parameters through interim (postburn-in) electrical parameters of method 5004 and substitute lines 1 through 6 of table IIA herein.
- b. Prior to burn-in, the devices shall be programmed (see 4.7 herein) with a checkerboard pattern or equivalent (manufacturers at their option may employ an equivalent pattern provided it is a topologically true alternating bit pattern). The pattern shall be read before and after burn-in. Devices having bits not in the proper state after burn-in shall constitute a device failure and shall be included in the Percent Defective Allowable (PDA) calculation and shall be removed from the lot. The manufacturer as an option may use built-in test circuitry by testing the entire lot to verify programmability and AC performance without programming the user array.
- c. For device class M, the test circuit shall be maintained by the manufacturer under document revision level control and shall be made available to the preparing or acquiring activity upon request. For device class M, the test circuit shall specify the inputs, outputs, biases, and power dissipation, as applicable, in accordance with the intent specified in test method 1015.

(1) Dynamic burn-in for device class M (method 1015 of MIL-STD-883, test condition D; for circuit, see 4.2.1b herein).

- d. Interim and final electrical parameters shall be as specified in table IIA herein.

**4.2.2 Additional criteria for device classes Q and V.**

- a. The burn-in test duration, test condition and test temperature, or approved alternatives shall be as specified in the device manufacturer's QM plan in accordance with MIL-I-38535. The burn-in test circuit shall be maintained under document revision level control of the device manufacturer's Technology Review Board (TRB) in accordance with MIL-I-38535 and shall be made available to the acquiring or preparing activity upon request. The test circuit shall specify the inputs, outputs, biases, and power dissipation, as applicable, in accordance with the intent specified in test method 1015.
- b. Interim and final electrical test parameters shall be as specified in table IIA herein.
- c. Additional screening for device class V beyond the requirements of device class Q shall be as specified in appendix B of MIL-I-38535.

**4.3 Qualification inspection for device classes Q and V.** Qualification inspection for device classes Q and V shall be in accordance with MIL-I-38535. Inspections to be performed shall be those specified in MIL-I-38535 and herein for groups A, B, C, D, and E inspections (see 4.4.1 through 4.4.4).

**4.4 Conformance inspection.** Quality conformance inspection for device class M shall be in accordance with MIL-STD-883 (see 3.1 herein) and as specified herein. Inspections to be performed for device class M shall be those specified in method 5005 of MIL-STD-883 and herein for groups A, B, C, D, and E inspections (see 4.4.1 through 4.4.4). Technology conformance inspection for classes Q and V shall be in accordance with MIL-I-38535 including groups A, B, C, D, and E inspections and as specified herein except where option 2 of MIL-I-38535 permits alternate in-line control testing.

STANDARDIZED MILITARY DRAWING DEFENSE ELECTRONICS SUPPLY CENTER DAYTON, OHIO 45444	SIZE <b>A</b>		5962-90989
		REVISION LEVEL	SHEET 9

DESC FORM 193A  
 JUL 91

74E ■ 9004708 0000272 56T ■

Device types	01 through 03	
Case outlines	L	3
Terminal number	Terminal symbol	
1	$\overline{PL}$	$\overline{PL}$
2	I <sub>0</sub>	I <sub>0</sub>
3	I <sub>1</sub>	I <sub>1</sub>
4	I <sub>2</sub>	NC
5	I <sub>3</sub>	I <sub>2</sub>
6	I <sub>4</sub>	I <sub>3</sub>
7	I <sub>5</sub>	I <sub>4</sub>
8	I <sub>6</sub>	I <sub>5</sub>
9	I <sub>7</sub>	I <sub>6</sub>
10	I <sub>8</sub>	I <sub>7</sub>
11	I <sub>9</sub>	NC
12	GND	I <sub>8</sub>
13	$\overline{OE}$	I <sub>9</sub>
14	I/O <sub>9</sub>	GND
15	I/O <sub>8</sub>	$\overline{OE}$
16	I/O <sub>7</sub>	I/O <sub>9</sub>
17	I/O <sub>6</sub>	I/O <sub>8</sub>
18	I/O <sub>5</sub>	NC
19	I/O <sub>4</sub>	I/O <sub>7</sub>
20	I/O <sub>3</sub>	I/O <sub>6</sub>
21	I/O <sub>2</sub>	I/O <sub>5</sub>
22	I/O <sub>1</sub>	I/O <sub>4</sub>
23	I/O <sub>0</sub>	I/O <sub>3</sub>
24	V <sub>CC</sub>	I/O <sub>2</sub>
25	---	NC
26	---	I/O <sub>1</sub>
27	---	I/O <sub>0</sub>
28	---	V <sub>CC</sub>

FIGURE 1. Terminal connections.

STANDARDIZED MILITARY DRAWING DEFENSE ELECTRONICS SUPPLY CENTER DAYTON, OHIO 45444	SIZE <b>A</b>		5962-90989
		REVISION LEVEL	SHEET 10

DESC FORM 193A  
 JUL 91

74E ■ 9004708 0000273 4T6 ■

Truth table			
Input pins			Output pins
$\overline{OE}$	$\overline{PL}$	I	O
X	X	X	Z

- NOTES:  
 1. Z = High impedance  
 2. X = Don't care

FIGURE 2. Truth table (unprogrammed).

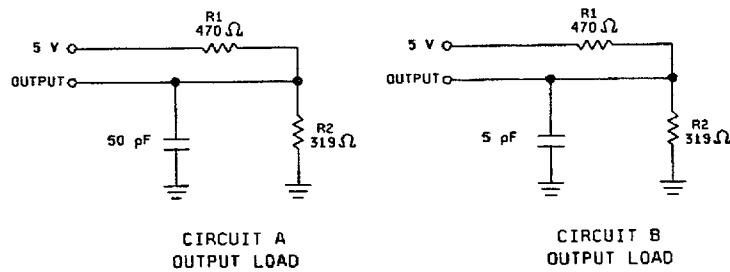

\*Including scope and jig (minimum values)

AC test conditions	
Input pulse levels	GND to 3.0 V
Input rise and fall times	≤ 5 ns
Input timing reference levels	1.5 V
Output reference levels	1.5 V

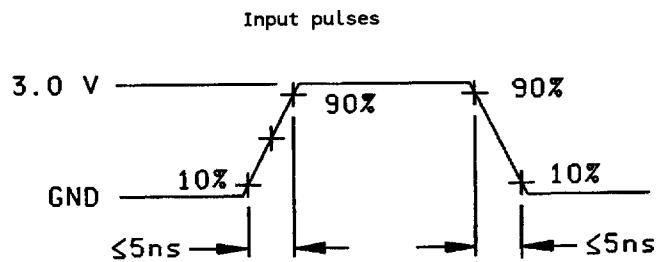

FIGURE 3. Output load circuits and test conditions.

STANDARDIZED MILITARY DRAWING DEFENSE ELECTRONICS SUPPLY CENTER DAYTON, OHIO 45444	SIZE A	5962-90989
	REVISION LEVEL	SHEET 11

DESC FORM 193A  
 JUL 91

74E ■ 9004708 0000274 332 ■

Output control switching waveform

PARAMETER	$V_X$	OUTPUT WAVEFORM - MEASUREMENT LEVEL
$t_{PXZ(-)}$ $t_{ER(-)}$	1.5 V	
$t_{PXZ(+)}$ $t_{ER(+)}$	2.6 V	
$t_{PZX(+)}$ $t_{EA(+)}$	2.02 V	
$t_{PZX(-)}$ $t_{EA(-)}$	2.02 V	

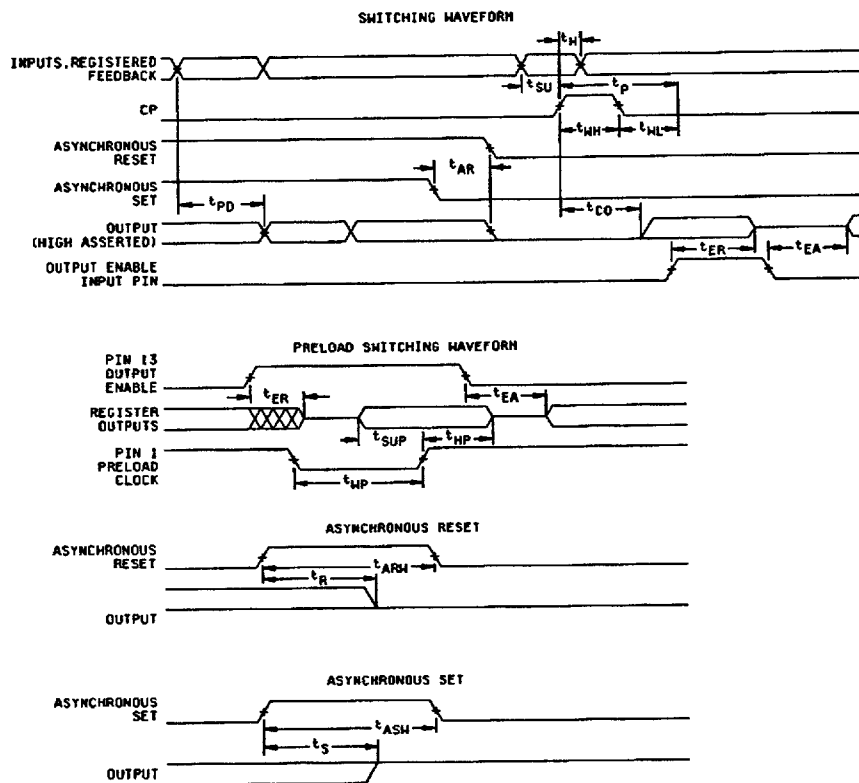

FIGURE 4. Switching waveform.

STANDARDIZED  
MILITARY DRAWING  
DEFENSE ELECTRONICS SUPPLY CENTER  
DAYTON, OHIO 45444

SIZE  
A

5962-90989

REVISION LEVEL

SHEET

12

DESC FORM 193A  
JUL 91

74E ■ 9004708 0000275 279 ■

4.4.1 Group A inspection.

- a. Tests shall be as specified in table IIA herein.
- b. Subgroups 5 and 6 of table I of method 5005 of MIL-STD-883 shall be omitted.
- c. For device class M, subgroups 7, 8A, and 8B tests shall be sufficient to verify the truth table. For device classes Q and V, subgroups 7 and 8 shall include verifying the functionality of the device; these tests shall have been fault graded in accordance with MIL-STD-883, test method 5012 (see 1.5 herein).
- d. O/V (latch-up) tests shall be measured only for initial qualification and after any design or process changes which may affect the performance of the device. For device class M, procedures and circuits shall be maintained under document revision level control by the manufacturer and shall be made available to the preparing activity or acquiring activity upon request. For device classes Q and V, the procedures and circuits shall be under the control of the device manufacturer's TRB in accordance with MIL-I-38535 and shall be made available to the preparing activity or acquiring activity upon request. Testing shall be on all pins, on five devices with zero failures. Latch-up test shall be considered destructive. Information contained in JEDEC standard number 17 may be used for reference.
- e. Subgroup 4 (C<sub>IN</sub> and C<sub>OUT</sub> measurements) shall be measured only for initial qualification and after any process or design changes which may affect input or output capacitance. Capacitance shall be measured between the designated terminal and GND at a frequency of 1 MHz. Sample size is 15 devices with no failures, and all input and output terminals tested.
- f. Devices shall be tested for programmability and ac performance compliance to the requirements of Group A, subgroups 9, 10, and 11. Either of two techniques is acceptable:
  - (1) Testing the lot using additional built-in test circuitry which allows the manufacturer to verify programmability and ac performance without programming the user array. If this is done, the resulting test pattern shall be verified on all devices during subgroups 9, 10, and 11, group A testing per the sampling plan specified in MIL-STD-883, method 5005.
  - (2) If such compliance cannot be tested on an unprogrammed device, a sample shall be selected to satisfy programmability requirements prior to performing subgroups 9, 10, and 11. Twelve devices shall be submitted to programming (see 3.2.3.1). If any device fails to program, the lot shall be rejected. At the manufacturers option, the sample may be increased to 24 total devices with no more than one total device failure allowable. Ten devices from the programmability sample shall be submitted to the requirements of group A, subgroups 9, 10, and 11. If any device fails, the lot shall be rejected. At the manufacturers option, the sample may be increased to 20 total devices with no more than one total device failure allowable. After completion of all testing, the devices shall be erased and verified except devices submitted to groups C and D testing.

4.4.2 Group C inspection. The group C inspection end-point electrical parameters shall be as specified in table IIA herein. Delta limits shall apply only to subgroup 1 of group C inspection and shall consist of tests specified in table IIB herein.

4.4.2.1 Additional criteria for device class M. Steady-state life test conditions, method 1005 of MIL-STD-883:

- a. Test condition D. The test circuit shall be maintained by the manufacturer under document revision level control and shall be made available to the preparing or acquiring activity upon request. The test circuit shall specify the inputs, outputs, biases, and power dissipation, as applicable, in accordance with the intent specified in test method 1005.
- b. T<sub>A</sub> = +125°C, minimum.
- c. Test duration: 1,000 hours, except as permitted by method 1005 of MIL-STD-883.

4.4.2.2 Additional criteria for device classes Q and V. The steady-state life test duration, test condition and test temperature, or approved alternatives shall be as specified in the device manufacturer's QM plan in accordance with MIL-I-38535. The test circuit shall be maintained under document revision level control by the device manufacturer's TRB, in accordance with MIL-I-38535, and shall be made available to the acquiring or preparing activity upon request. The test circuit shall specify the inputs, outputs, biases, and power dissipation, as applicable, in accordance with the intent specified in test method 1005.

STANDARDIZED MILITARY DRAWING DEFENSE ELECTRONICS SUPPLY CENTER DAYTON, OHIO 45444	SIZE <b>A</b>		5962-90989
		REVISION LEVEL	SHEET 13

DESC FORM 193A  
 JUL 91

74E ■ 9004708 0000276 105 ■

4.4.3 Group D inspection. The group D inspection end-point electrical parameters shall be as specified in table IIA herein.

4.4.4 Group E inspection. Group E inspection is required only for parts intended to be marked as radiation hardness assured (see 3.5 herein). RHA levels for device classes Q and V shall be M, D, R, and H and for device class M shall be M and D.

- a. End-point electrical parameters shall be as specified in table II herein.
- b. For device class M, the devices shall be subjected to radiation hardness assured tests as specified in MIL-I-38535, appendix A, for the RHA level being tested. For device classes Q and V, the devices or test vehicle shall be subjected to radiation hardness assured tests as specified in MIL-I-38535 for the RHA level being tested. All device classes must meet the postirradiation end-point electrical parameter limits as defined in table I at  $T_A = +25^\circ\text{C} \pm 5^\circ\text{C}$ , after exposure, to the subgroups specified in table IIA herein.
- c. When specified in the purchase order or contract, a copy of the RHA delta limits shall be supplied.

4.5 Delta measurements for device classes Q and V. Delta measurements, as specified in table IIA, shall be made and recorded before and after the required burn-in screens and steady-state life tests to determine delta compliance. The electrical parameters to be measured, with associated delta limits are listed in table IIB. The device manufacturer may, at his option, either perform delta measurements or within 24 hours after burn-in perform final electrical parameter tests, subgroups 1, 7, and 9.

4.6 Erasing procedure. The recommended erasure procedure is exposure to shortwave ultraviolet light which has a wavelength of 2,537 Angstroms ( $\text{\AA}$ ). The integrated dose (i.e., ultraviolet intensity times exposure time) for erasure should be minimum of  $15 \text{ Ws/cm}^2$ . The erasure time with this dosage is approximately 15 to 20 minutes using an ultraviolet lamp with a  $12,000 \mu\text{W/cm}^2$  power rating. The device should be placed within 1 inch of the lamp tubes during erasure. The maximum integrated dose the device can be exposed to without damage is  $7,258 \text{ Ws/cm}^2$  (1 week at  $12,000 \mu\text{W/cm}^2$ ). Exposure of the device to high intensity ultraviolet light for long periods may cause permanent damage.

4.7 Programming procedures. The programming procedures shall be as specified by the device manufacturer and shall be made available upon request.

## 5. PACKAGING

5.1 Packaging requirements. The requirements for packaging shall be in accordance with MIL-STD-883 (see 3.1 herein) for device class M and MIL-I-38535 for device classes Q and V.

## 6. NOTES

(This section contains information of a general or explanatory nature that may be helpful, but is not mandatory.)

6.1 Intended use. Microcircuits conforming to this drawing are intended for use for Government microcircuit applications (original equipment), design applications, and logistics purposes.

6.1.1 Replaceability. Microcircuits covered by this drawing will replace the same generic device covered by a contractor-prepared specification or drawing.

6.1.2 Substitutability. Device class Q devices will replace device class M devices.

6.2 Configuration control of SMD's. All proposed changes to existing SMD's will be coordinated with the users of record for the individual documents. This coordination will be accomplished in accordance with MIL-STD-973 using DD Form 1692, Engineering Change Proposal.

6.3 Record of users. Military and industrial users shall inform Defense Electronics Supply Center when a system application requires configuration control and which SMD's are applicable to that system. DESC will maintain a record of users and this list will be used for coordination and distribution of changes to the drawings. Users of drawings covering microelectronic devices (FSC 5962) should contact DESC-EC, telephone (513) 296-6047.

6.4 Comments. Comments on this drawing should be directed to DESC-EC, Dayton, Ohio 45444-5270, or telephone (513) 296-5377.

STANDARDIZED MILITARY DRAWING DEFENSE ELECTRONICS SUPPLY CENTER DAYTON, OHIO 45444	SIZE A		5962-90989
		REVISION LEVEL	SHEET 14

DESC FORM 193A  
JUL 91

74E ■ 9004708 0000277 041 ■

TABLE IIA. Electrical test requirements. 1/ 2/ 3/ 4/ 5/ 6/ 7/

Line no.	Test requirements	Subgroups (in accordance with MIL-STD-883, method 5005, table I)		
		Device class M	Device class Q	Device class V
1	Interim electrical parameters (see 4.2)		1,7,9	1,7,9
2	Static burn-in I and II (method 1015)	Not required	Not required	Required
3	Same as line 1			1*,7* Δ
4	Dynamic burn-in (method 1015)	Required	Required	Required
5	Same as line 1			1*,7* Δ
6	Final electrical parameters	1*,2,3,7*,8A,8B,9,10,11	1*,2,3,7*,8A,8B,9,10,11	1*,2,3,7*,8A,8B,9,10,11
7	Group A test requirements	1,2,3,4**,7,8A,8B,9,10,11	1,2,3,4**,7,8A,8B,9,10,11	1,2,3,4**,7,8A,8B,9,10,11
8	Group C end-point electrical parameters	2,3,7,8A,8B	1,2,3,7,8A,8B Δ	1,2,3,7,8A,8B,9,10,11 Δ
9	Group D end-point electrical parameters	2,3,8A,8B	2,3,8A,8B	2,3,8A,8B
10	Group E end-point electrical parameters	1,7,9	1,7,9	1,7,9

- 1/ Blank spaces indicate tests are not applicable.
- 2/ Any or all subgroups may be combined when using high-speed testers.
- 3/ Subgroups 7 and 8 functional tests shall verify the truth table.
- 4/ \* indicates PDA applies to subgroup 1 and 7.
- 5/ \*\* see 4.4.1e.
- 6/ Δ indicates delta limit (see table IIB) shall be required where specified, and the delta values shall be computed with reference to the previous interim electrical parameters (see line 1).
- 7/ See 4.4.1d.

STANDARDIZED MILITARY DRAWING DEFENSE ELECTRONICS SUPPLY CENTER DAYTON, OHIO 45444	SIZE <b>A</b>		5962-90989
		REVISION LEVEL	SHEET 15

DESC FORM 193A  
 JUL 91

74E ■ 9004708 0000278 T88 ■

TABLE IIB. Delta limits at +25°C.

Parameter 1/	Device types
	ALL
I <sub>CC1</sub> Standby	±1% of specified limit in table I.
I <sub>IX</sub> , I <sub>OZ</sub>	±1% of specified limit in table I.



1/ The above parameter shall be recorded before and after the required burn-in and life tests to determine the delta.

6.5 Abbreviations, symbols, and definitions. The abbreviations, symbols, and definitions used herein are defined in MIL-M-38535, MIL-STD-1331, and as follows:

C <sub>IN</sub> , C <sub>OUT</sub>	Input and bidirectional output, terminal-to-GND capacitance
GND	Ground zero voltage potential
I <sub>CC</sub>	Supply current
T <sub>C</sub>	Case temperature
T <sub>A</sub>	Ambient temperature
V <sub>CC</sub>	Positive supply voltage

6.5.1 Timing limits. The table of timing values shows either a minimum or a maximum limit for each parameter. Input requirements are specified from the external system point of view. Thus, address setup time is shown as a minimum since the system must supply at least that much time (even though most devices do not require it). On the other hand, responses from the memory are specified from the device point of view. Thus, the access time is shown as a maximum since the device never provides data later than that time.

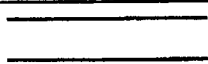
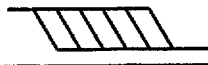
6.5.2 Waveforms.

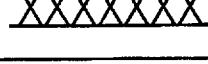
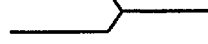
Waveform symbol	Input	Output
	MUST BE VALID	WILL BE VALID
	CHANGE FROM H TO L	WILL CHANGE FROM H TO L
	CHANGE FROM L TO H	WILL CHANGE FROM L TO H
	DON'T CARE ANY CHANGE PERMITTED	CHANGING STATE UNKNOWN
		HIGH IMPEDANCE

STANDARDIZED MILITARY DRAWING DEFENSE ELECTRONICS SUPPLY CENTER DAYTON, OHIO 45444	SIZE A		5962-90989
		REVISION LEVEL	SHEET 16

DESC FORM 193A  
JUL 91

74E ■ 9004708 0000279 914 ■



6.6 One part - one part number system. The one part - one part number system described below has been developed to allow for transitions between identical generic devices covered by the three major microcircuit requirements documents (MIL-H-38534, MIL-I-38535, and 1.2.1 of MIL-STD-883) without the necessity for the generation of unique PIN's. The three military requirements documents represent different class levels, and previously when a device manufacturer upgraded military product from one class level to another, the benefits of the upgraded product were unavailable to the Original Equipment Manufacturer (OEM), that was contractually locked into the original unique PIN. By establishing a one part number system covering all three documents, the OEM can acquire to the highest class level available for a given generic device to meet system needs without modifying the original contract parts selection criteria.

<u>Military documentation format</u>	<u>Example PIN under new system</u>	<u>Manufacturing source listing</u>	<u>Document listing</u>
New MIL-H-38534 Standardized Military Drawings	5962-XXXXZZ(H or K)YY	QML-38534	MIL-BUL-103
New MIL-I-38535 Standardized Military Drawings	5962-XXXXZZ(Q or V)YY	QML-38535	MIL-BUL-103
New 1.2.1 of MIL-STD-883 Standardized Military Drawings	5962-XXXXZZ(M)YY	MIL-BUL-103	MIL-BUL-103

6.7 Sources of supply.

6.7.1 Sources of supply for device classes Q and V. Sources of supply for device classes Q and V are listed in QML-38535. The vendors listed in QML-38535 have submitted a certificate of compliance (see 3.8 herein) to DESC-EC and have agreed to this drawing.

6.7.2 Approved sources of supply for device class M. Approved sources of supply for class M are listed in MIL-BUL-103. The vendors listed in MIL-BUL-103 have agreed to this drawing and a certificate of compliance (see 3.8 herein) has been submitted to and accepted by DESC-EC.

<b>STANDARDIZED MILITARY DRAWING DEFENSE ELECTRONICS SUPPLY CENTER DAYTON, OHIO 45444</b>	<b>SIZE A</b>		<b>5962-90989</b>
		REVISION LEVEL	SHEET 17

DESC FORM 193A  
JUL 91

74E ■ 9004708 0000280 636 ■