



2SB1132

PNP SILICON TRANSISTOR

MEDIUM POWER TRANSISTOR

DESCRIPTION

The UTC **2SB1132** is a epitaxial planar type PNP silicon transistor.

FEATURES

* Low $V_{CE(SAT)}$.

$V_{CE(SAT)} = -0.2V(Typ.)$ ($I_C/I_B = -500mA/-50mA$)

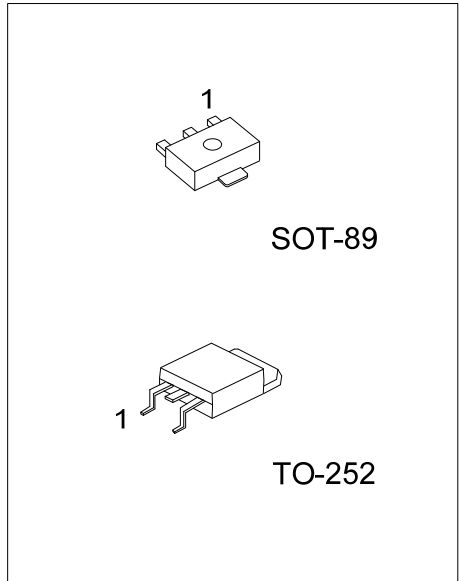

ORDERING INFORMATION

Ordering Number		Package	Pin Assignment			Packing
Lead Free	Halogen Free		1	2	3	
2SB1132L-x-AB3-R	2SB1132G-x-AB3-R	SOT-89	B	C	E	Tape Reel
2SB1132L-x-TN3-R	2SB1132G-x-TN3-R	TO-252	B	C	E	Tape Reel
2SB1132L-x-TN3-T	2SB1132G-x-TN3-T	TO-252	B	C	E	Tube

<p>2SB1132L-x-AB3-R</p> <p>(1)Packing Type (2)Package Type (3)Rank (4)Lead Free</p>	<p>(1) R: Tape Reel, T: Tube (2) AB3: SOT-89, TN3: TO-252 (3) x: refer to Classification of h_{FE} (4) G: Halogen Free, L: Lead Free</p>
---	---

■ ABSOLUTE MAXIMUM RATINGS ($T_A=25^\circ\text{C}$, unless otherwise specified)

PARAMETER	SYMBOL	RATINGS	UNIT
Collector-Base Voltage	V_{CBO}	-40	V
Collector-Emitter Voltage	V_{CEO}	-32	V
Emitter-Base Voltage	V_{EBO}	-5	V
Collector Current	DC	-1	A
Collector Current (Single pulse, Pw=100ms)	PULSE		
Collector Power Dissipation	SOT-89	0.5	W
	TO-252	1	W
Junction Temperature	T_J	150	$^\circ\text{C}$
Storage Temperature	T_{STG}	-55 ~ +150	$^\circ\text{C}$

Note: Absolute maximum ratings are those values beyond which the device could be permanently damaged.

Absolute maximum ratings are stress ratings only and functional device operation is not implied.

■ ELECTRICAL CHARACTERISTICS ($T_A=25^\circ\text{C}$, unless otherwise specified)

PARAMETER	SYMBOL	TEST CONDITIONS	MIN	TYP	MAX	UNIT
Collector Base Breakdown Voltage	BV_{CBO}	$I_C = -50\mu\text{A}$	-40			V
Collector Emitter Breakdown Voltage	BV_{CEO}	$I_C = -1\text{mA}$	-32			V
Emitter Base Breakdown Voltage	BV_{EBO}	$I_E = -50\mu\text{A}$	-5			V
Collector Cut-Off Current	I_{CBO}	$V_{CB} = -20\text{V}$			-0.5	μA
Emitter Cut-Off Current	I_{EBO}	$V_{EB} = -4\text{V}$			-0.5	μA
Collector-Emitter Saturation Voltage	$V_{CE(SAT)}$	$I_C = -500\text{mA}, I_B = -50\text{mA}$ (Note)		-0.2	-0.5	V
DC Current Transfer Ratio	h_{FE}	$V_{CE} = -3\text{V}, I_C = -0.1\text{A}$ (Note)	82		390	
Transition Frequency	f_T	$V_{CE} = -5\text{V}, I_E = 50\text{mA}, f = 30\text{MHz}$		150		MHz
Output Capacitance	C_{OB}	$V_{CB} = -10\text{V}, I_E = 0\text{A}, f = 1\text{MHz}$		20	30	pF

Note: Measured using pulse current.

■ CLASSIFICATION OF h_{FE}

RANK	P	Q	R
RANGE	82-180	120-270	180-390

TYPICAL CHARACTERISTICS

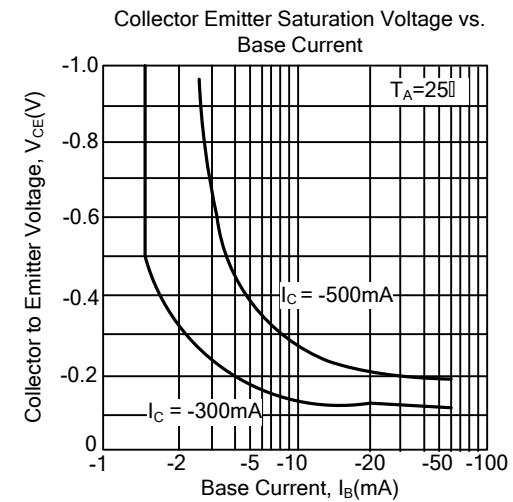
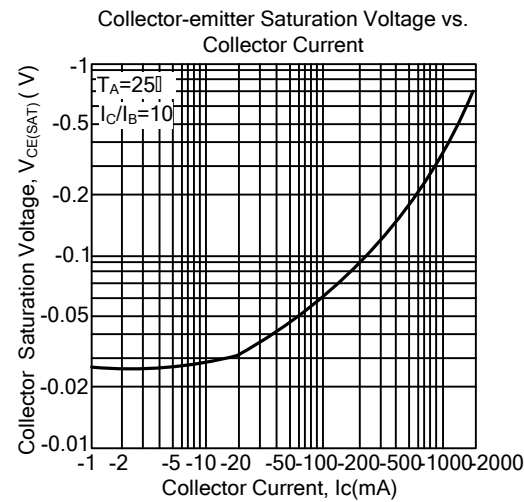
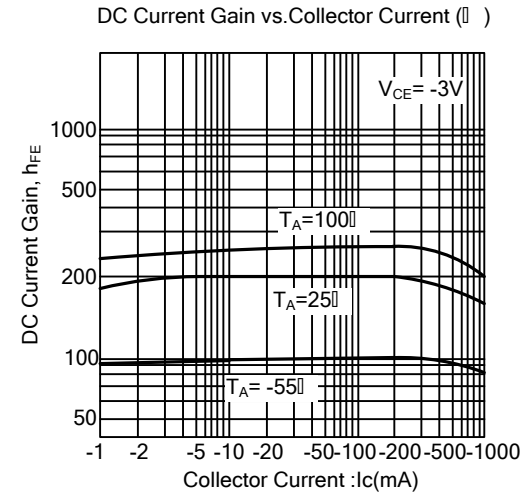
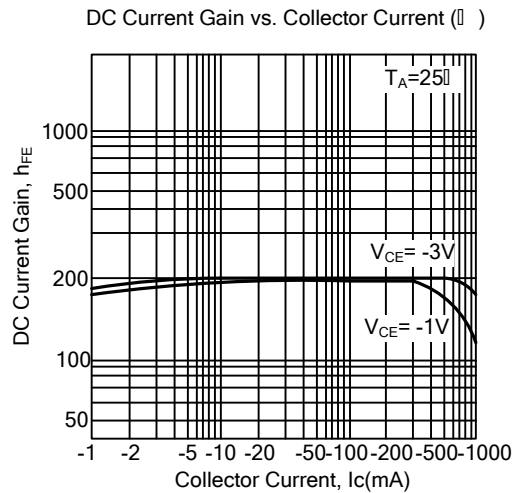
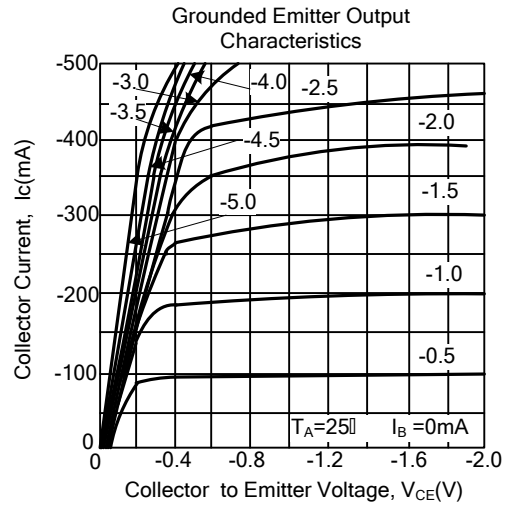
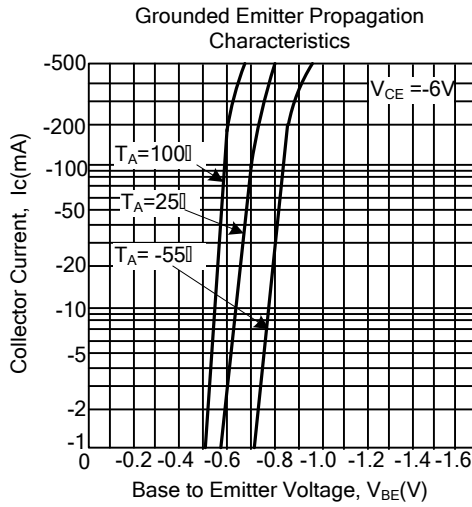

TYPICAL CHARACTERISTICS(Cont.)

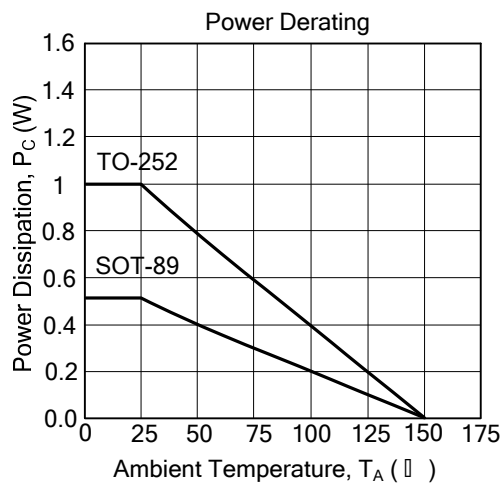
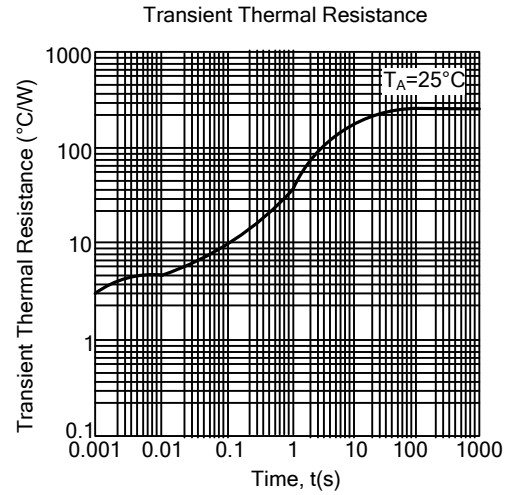
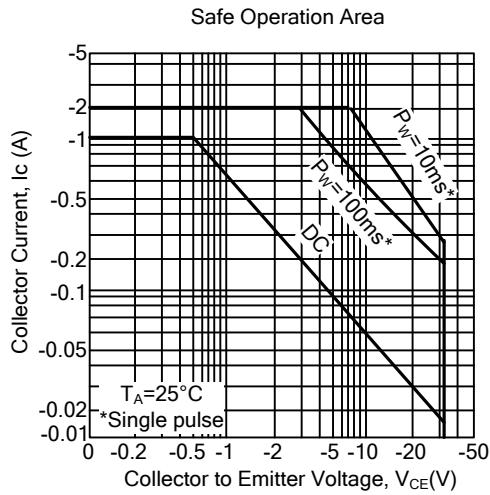
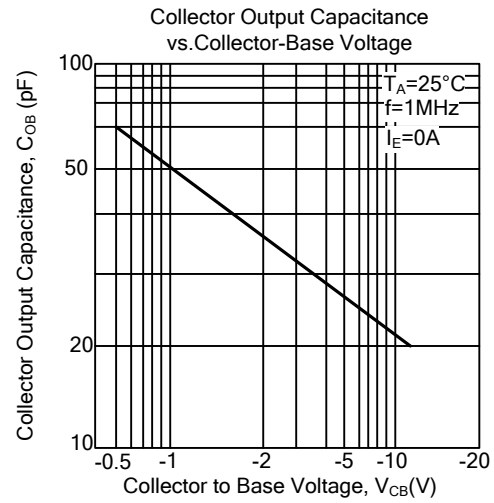
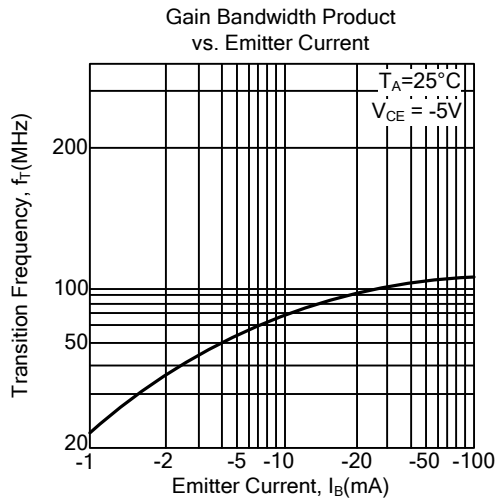

UTC assumes no responsibility for equipment failures that result from using products at values that exceed, even momentarily, rated values (such as maximum ratings, operating condition ranges, or other parameters) listed in products specifications of any and all UTC products described or contained herein. UTC products are not designed for use in life support appliances, devices or systems where malfunction of these products can be reasonably expected to result in personal injury. Reproduction in whole or in part is prohibited without the prior written consent of the copyright owner. The information presented in this document does not form part of any quotation or contract, is believed to be accurate and reliable and may be changed without notice.