

S7030/S7031 series

Back-thinned FFT-CCD

The S7030/S7031 series is a family of FFT-CCD image sensors specifically designed for low-light-level detection in scientific applications. By using the binning operation, the S7030/S7031 series can be used as a linear image sensor having a long aperture in the direction of the device length. This makes the S7030/S7031 series suited for use in spectrophotometry. The binning operation offers significant improvement in S/N and signal processing speed compared with conventional methods by which signals are digitally added by an external circuit. The S7030/S7031 series also features low noise and low dark signal (MPP mode operation). This enables low-light-level detection and long integration time, thus achieving a wide dynamic range. The S7030/S7031 series has an effective pixel size of $24 \times 24 \mu\text{m}$ and is available in image areas ranging from $12.288 \text{ (H)} \times 1.392 \text{ (V)} \text{ mm}^2$ (512×58 pixels) up to a large image area of $24.576 \text{ (H)} \times 2.928 \text{ (V)} \text{ mm}^2$ (1024×250 pixels).

Features

- **Non-cooled type: S7030 series**
One-stage TE-cooled type: S7031 series
- **Pixel size: $24 \times 24 \mu\text{m}$**
- **Line, pixel binning**
- **Greater than 90% quantum efficiency at peak sensitivity wavelength**
- **Wide spectral response range**
- **Low readout noise**
- **Wide dynamic range**
- **MPP operation**
- **High UV sensitivity with good stability**

Applications

- **Fluorescence spectrometer, ICP**
- **Industrial inspection**
- **Semiconductor inspection**
- **DNA sequencer**
- **Low-light-level detection**
- **Raman spectrometer**

Selection guide

Type No.	Cooling	Number of total pixels	Number of active pixels	Active area [mm (H) × mm (V)]	Suitable multichannel detector head
S7030-0906	Non-cooled	532 × 64	512 × 58	12.288 × 1.392	C7040
S7030-0907		532 × 128	512 × 122	12.288 × 2.928	
S7030-1006		1044 × 64	1024 × 58	24.576 × 1.392	
S7030-1007		1044 × 128	1024 × 122	24.576 × 2.928	
S7031-0906S	One-stage TE-cooled	532 × 64	512 × 58	12.288 × 1.392	C7041
S7031-0907S		532 × 128	512 × 122	12.288 × 2.928	
S7031-1006S		1044 × 64	1024 × 58	24.576 × 1.392	
S7031-1007S		1044 × 128	1024 × 122	24.576 × 2.928	

General ratings

Parameter	S7030 series	S7031 series
Pixel size	24 (H) × 24 (V) μm	
Vertical clock phase	2 phases	
Horizontal clock phase	2 phases	
Output circuit	One-stage MOSFET source follower	
Package	24-pin ceramic DIP (refer to dimensional outlines)	
Window*1	Quartz glass	AR-coated sapphire

*1: Temporary window type (ex. S7030-0906N) is available upon request.
(Temporary window is fixed by tape to protect the CCD chip and wire bonding.)

Absolute maximum ratings (Ta=25 °C)

Parameter	Symbol	Min.	Typ.	Max.	Unit
Operating temperature*2	Topr	-50	-	+50	°C
Storage temperature	Tstg	-50	-	+70	°C
Output transistor drain voltage	VOD	-0.5	-	+25	V
Reset drain voltage	VRD	-0.5	-	+18	V
Vertical input source voltage	VISV	-0.5	-	+18	V
Horizontal input source voltage	VISH	-0.5	-	+18	V
Vertical input gate voltage	VIG1V, VIG2V	-10	-	+15	V
Horizontal input gate voltage	VIG1H, VIG2H	-10	-	+15	V
Summing gate voltage	VSG	-10	-	+15	V
Output gate voltage	VOG	-10	-	+15	V
Reset gate voltage	VRG	-10	-	+15	V
Transfer gate voltage	VTG	-10	-	+15	V
Vertical shift register clock voltage	VP1V, VP2V	-10	-	+15	V
Horizontal shift register clock voltage	VP1H, VP2H	-10	-	+15	V

*2: Package temperature (S7030 series), chip temperature (S7031 series)

Operating conditions (MPP mode, Ta=25 °C)

Parameter	Symbol	Min.	Typ.	Max.	Unit
Output transistor drain voltage	VOD	18	20	22	V
Reset drain voltage	VRD	11.5	12	12.5	V
Output gate voltage	VOG	1	3	5	V
Substrate voltage	VSS	-	0	-	V
Test point	vertical input source	VISV	-	VRD	V
	horizontal input source	VISH	-	VRD	V
	vertical input gate	VIG1V, VIG2V	-9	-8	V
	horizontal input gate	VIG1H, VIG2H	-9	-8	V
Vertical shift register clock voltage	High	VP1VH, VP2VH	4	6	V
	Low	VP1VL, VP2VL	-9	-8	
Horizontal shift register clock voltage	High	VP1HH, VP2HH	4	6	V
	Low	VP1HL, VP2HL	-9	-8	
Summing gate voltage	High	VSGH	4	6	V
	Low	VSGL	-9	-8	
Reset gate voltage	High	VRGH	4	6	V
	Low	VRGL	-9	-8	
Transfer gate voltage	High	VTGH	4	6	V
	Low	VTGL	-9	-8	
External load resistance	RL	20	22	24	kΩ

Electrical characteristics (Ta=25 °C)

Parameter		Symbol	Min.	Typ.	Max.	Unit
Signal output frequency		fc	-	0.25	1	MHz
Vertical shift register capacitance	S703*-0906	CP1V, CP2V	-	750	-	pF
	S703*-0907/-1006		-	1500	-	
	S703*-1007		-	3000	-	
Horizontal shift register capacitance	S703*-0906/-0907	CP1H, CP2H	-	110	-	pF
	S703*-1006/-1007			180		
Summing gate capacitance		CSG	-	30	-	pF
Reset gate capacitance		CRG	-	30	-	pF
Transfer gate capacitance	S703*-0906/-0907	CTG	-	55	-	pF
	S703*-1006/-1007			75		
Charge transfer efficiency*3		CTE	0.99995	0.99999	-	-
DC output level*4		Vout	14	16	18	V
Output impedance*4		Zo	-	3	4	kΩ
Power consumption*4 *5		P	-	13	14	mW

*3: Charge transfer efficiency per pixel, measured at half of the full well capacity

*4: The values depend on the load resistance. (Typical, VOD=20 V, Load resistance=22 kΩ)

*5: Power consumption of the on-chip amplifier plus load resistance

Electrical and optical characteristics (Ta=25 °C, unless otherwise noted)

Parameter		Symbol	Min.	Typ.	Max.	Unit
Saturation output voltage		Vsat	-	Fw × Sv	-	V
Full well capacity	Vertical	Fw	240	320	-	ke ⁻
	Horizontal*6		800	1000	-	
CCD node sensitivity		Sv	1.8	2.2	-	μV/e ⁻
Dark current*7 (MPP mode)	25 °C	DS	-	100	1000	e ⁻ /pixel/s
	0 °C		-	10	100	
Readout noise*8		Nr	-	8	16	e ⁻ rms
Dynamic range*9	Line binning	DR	100000	125000	-	-
	Area scanning		30000	40000	-	-
Photo response non-uniformity*10		PRNU	-	±3	±10	%
Spectral response range		λ	-	200 to 1100	-	nm
Blemish	Point defect*11	White spots	-	-	0	-
		Black spots	-	-	10	-
	Cluster defect*12		-	-	3	-
	Column defect*13		-	-	0	-

*6: The linearity is ±1.5%.

*7: Dark current nearly doubles for every 5 to 7 °C increase in temperature.

*8: Measured with a HAMAMATSU C4880 digital CCD camera with a CDS circuit (sensor temperature: -40 °C, operating frequency: 150 kHz)

*9: Dynamic range = Full well capacity / Readout noise

*10: Measured at one-half of the saturation output (full well capacity) using LED light (peak emission wavelength: 560 nm)

$$\text{Photo response non-uniformity} = \frac{\text{Fixed pattern noise (peak to peak)}}{\text{Signal}} \times 100 \text{ [%]}$$

*11: White spots

Pixels whose dark current is higher than 1 ke⁻ after one-second integration at 0 °C.

Black spots

Pixels whose sensitivity is lower than one-half of the average pixel output. (measured with uniform light producing one-half of the saturation charge)

*12: 2 to 9 contiguous defective pixels

*13: 10 or more contiguous defective pixels

Spectral response (without window)*14

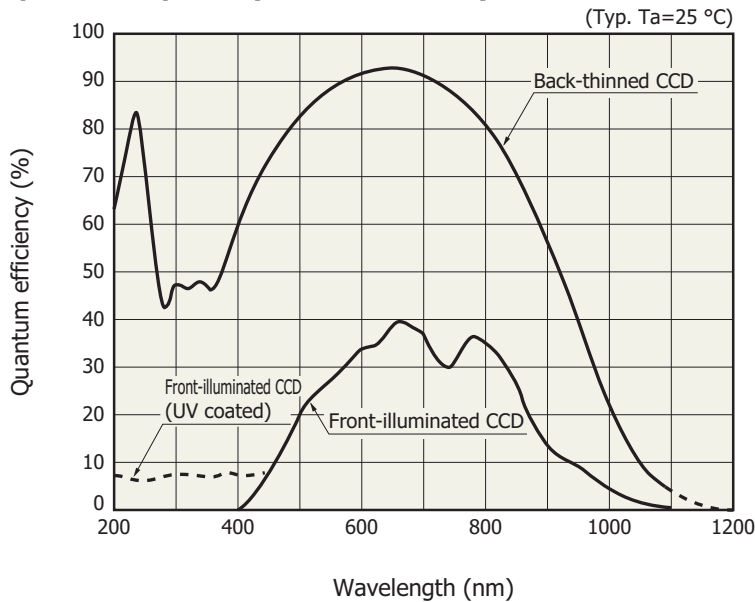

KMPDB0058EB

*14: Spectral response with quartz glass or AR-coated sapphire is decreased according to the spectral transmittance characteristic of window material.

Spectral transmittance characteristics

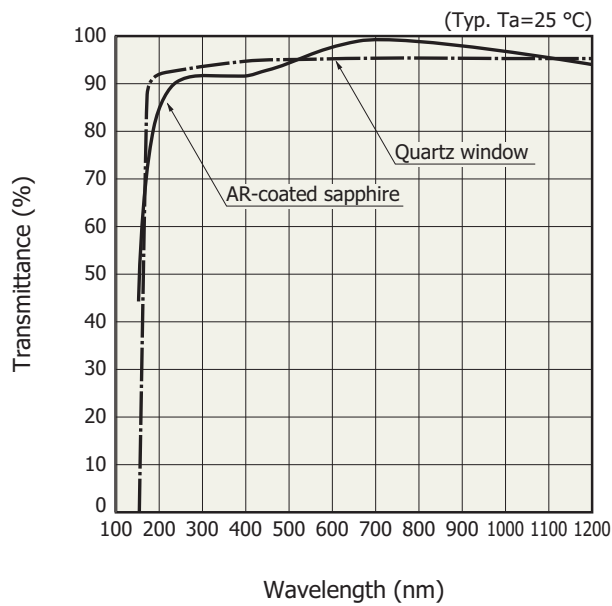

KMPDB0110EA

Dark current vs. temperature

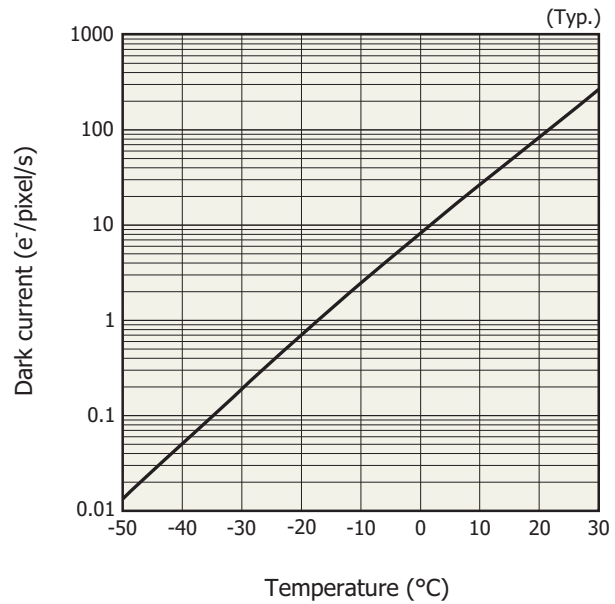

KMPDB0256EA

Window material

Type No.	Window material
S7030 series	Quartz glass*15 (option: window-less)
S7031 series	AR-coated sapphire*16 (option: window-less)
S7032-1006/-1007 (two-stage TE-cooled types, made to order)	AR-coated sapphire*16 (option: window-less)

*15: Resin sealing

*16: Hermetic sealing

Device structure (conceptual drawing of top view)

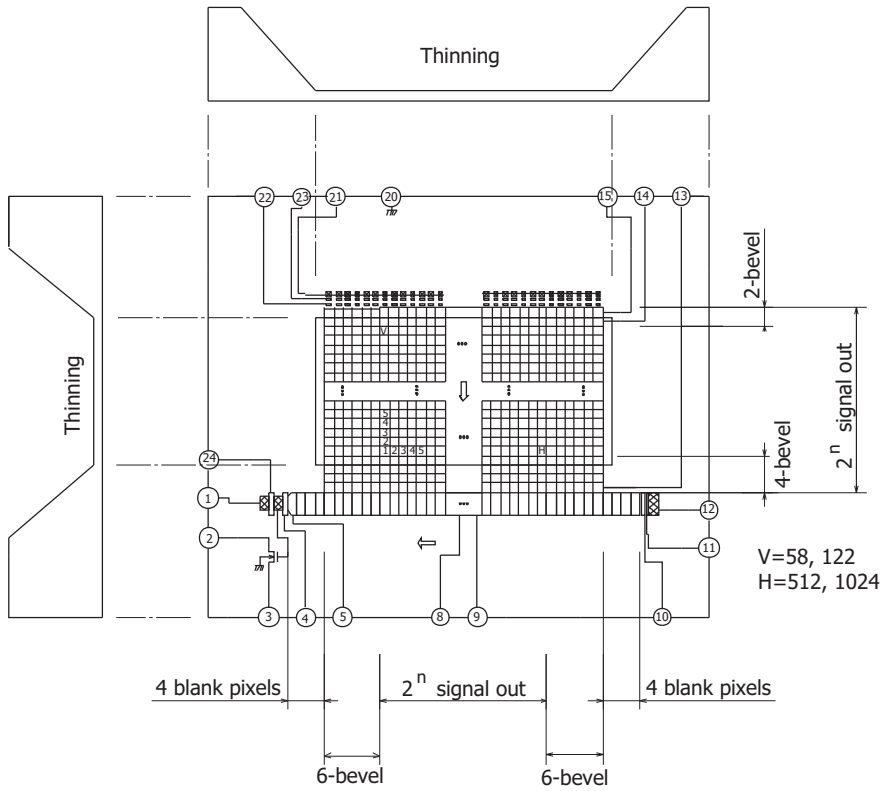

KMPDC0016EC

Timing chart

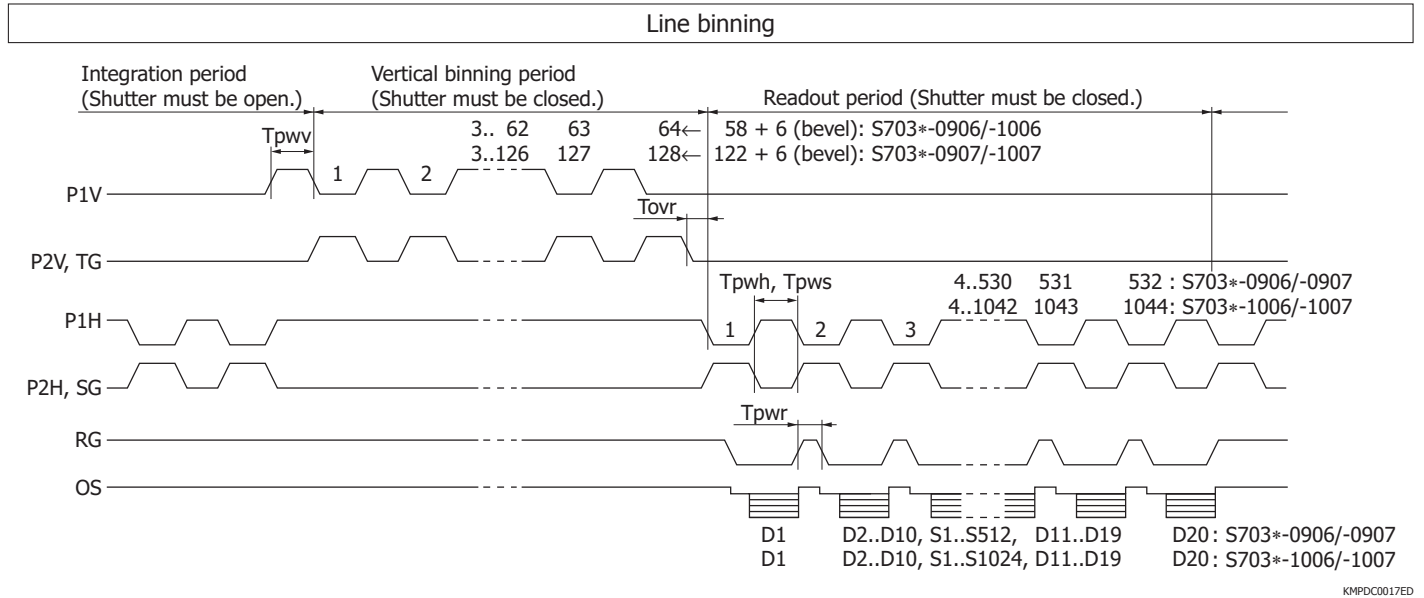

Parameter		Symbol	Min.	Typ.	Max.	Unit
P1V, P2V, TG*17	Pulse width	S703*-0906	1.5	2	-	μs
		S703*-0907/-1006	3	4	-	
		S703*-1007	6	8	-	
	Rise and fall time	T_{prv}, T_{pfv}	10	-	-	ns
P1H, P2H*17	Pulse width	T_{pwh}	500	2000	-	ns
	Rise and fall time	T_{prh}, T_{pfh}	10	-	-	ns
	Duty ratio	-	-	50	-	%
SG	Pulse width	T_{pws}	500	2000	-	ns
	Rise and fall time	T_{prs}, T_{pfs}	10	-	-	ns
	Duty ratio	-	-	50	-	%
RG	Pulse width	T_{pwr}	100	-	-	ns
	Rise and fall time	T_{prr}, T_{pfr}	5	-	-	ns
TG – P1H	Overlap time	T_{ovr}	3	-	-	μs

*17: The clock pulses should be overlapped at 50% of clock pulse amplitude.

Dimensional outlines (unit: mm)

S7030-0906/-0907

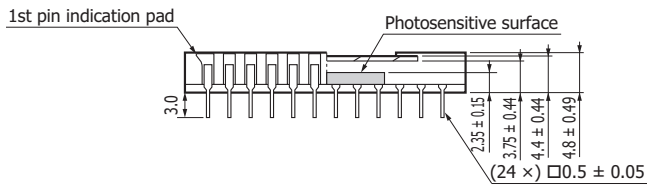
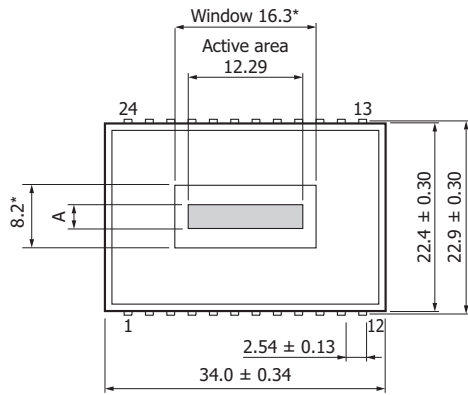

S7030-0906: A=1.392
S7030-0907: A=2.928

* Size of window that guarantees the transmittance in the "Spectral transmittance characteristics" graph

KMPDA0046EF

S7030-1006/-1007

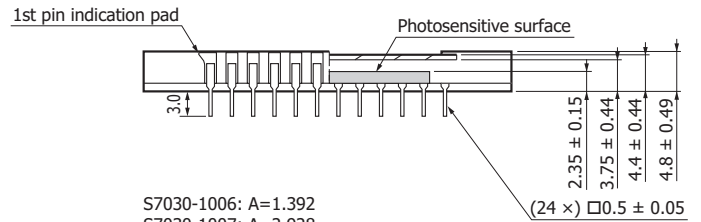
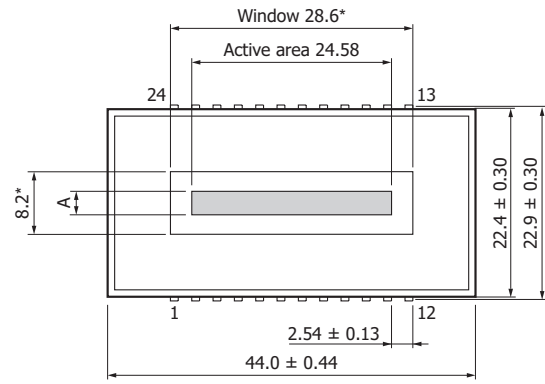

S7030-1006: A=1.392
S7030-1007: A=2.928

* Size of window that guarantees the transmittance in the "Spectral transmittance characteristics" graph

KMPDA0047EG

S7031-0906S/-0907S

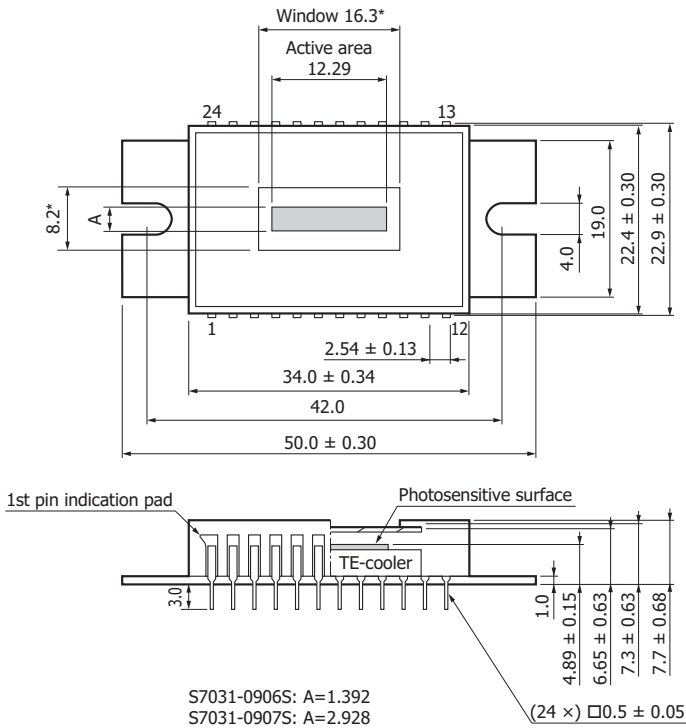

* Size of window that guarantees the transmittance in the "Spectral transmittance characteristics" graph

KMPDA0048EG

S7031-1006S/-1007S

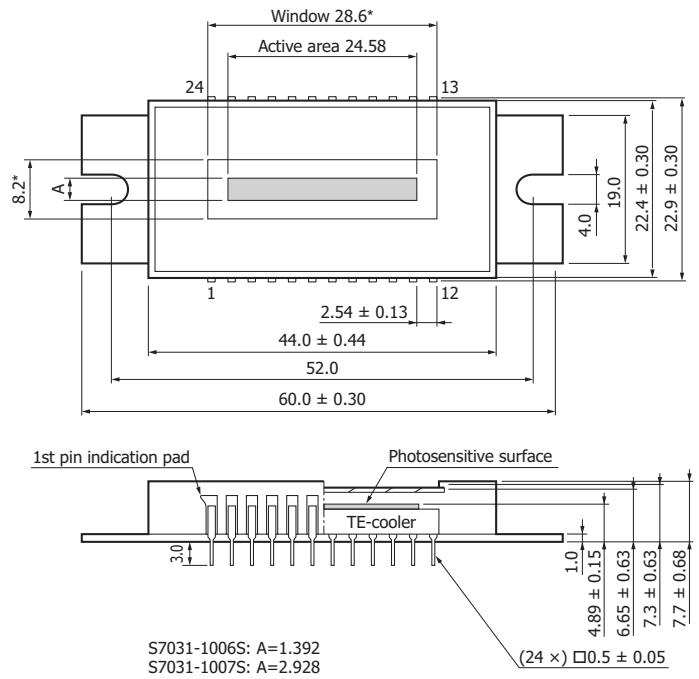

* Size of window that guarantees the transmittance in the "Spectral transmittance characteristics" graph

KMPDA0049EH

Pin connections

Pin No.	S7030 series		S7031 series		Remark (standard operation)
	Symbol	Function	Symbol	Function	
1	RD	Reset drain	RD	Reset drain	+12 V
2	OS	Output transistor source	OS	Output transistor source	$R_L=22\text{ k}\Omega$
3	OD	Output transistor drain	OD	Output transistor drain	+20 V
4	OG	Output gate	OG	Output gate	+3 V
5	SG	Summing gate	SG	Summing gate	Same pulse as P2H
6	-		-		
7	-		-		
8	P2H	CCD horizontal register clock-2	P2H	CCD horizontal register clock-2	
9	P1H	CCD horizontal register clock-1	P1H	CCD horizontal register clock-1	
10	IG2H	Test point (horizontal input gate-2)	IG2H	Test point (horizontal input gate-2)	-8 V
11	IG1H	Test point (horizontal input gate-1)	IG1H	Test point (horizontal input gate-1)	-8 V
12	ISH	Test point (horizontal input source)	ISH	Test point (horizontal input source)	Connect to RD
13	TG*19	Transfer gate	TG*19	Transfer gate	Same pulse as P2V
14	P2V	CCD vertical register clock-2	P2V	CCD vertical register clock-2	
15	P1V	CCD vertical register clock-1	P1V	CCD vertical register clock-1	
16	-		Th1	Thermistor	
17	-		Th2	Thermistor	
18	-		P-	TE-cooler-	
19	-		P+	TE-cooler+	
20	SS	Substrate (GND)	SS	Substrate (GND)	GND
21	ISV	Test point (vertical input source)	ISV	Test point (vertical input source)	Connect to RD
22	IG2V	Test point (vertical input gate-2)	IG2V	Test point (vertical input gate-2)	-8 V
23	IG1V	Test point (vertical input gate-1)	IG1V	Test point (vertical input gate-1)	-8 V
24	RG	Reset gate	RG	Reset gate	

*19: Isolation gate between vertical register and horizontal register. In standard operation, TG should be applied the same pulse as P2V.

Specifications of built-in TE-cooler (Typ. vacuum condition)

Parameter	Symbol	Condition	S7031-0906S/-0907S	S7031-1006S/-1007S	Unit
Internal resistance	R _{int}	T _a =25 °C	2.5	1.2	Ω
Maximum current*20	I _{max}	T _c *21=T _h *22=25 °C	1.5	3.0	A
Maximum voltage	V _{max}	T _c *21=T _h *22=25 °C	3.8	3.6	V
Maximum heat absorption*23	Q _{max}		3.4	5.1	W
Maximum temperature of heat radiating side	-		70	70	°C

*20: If the current greater than this value flows into the thermoelectric cooler, the heat absorption begins to decrease due to the Joule heat. It should be noted that this value is not the damage threshold value. To protect the thermoelectric cooler and maintain stable operation, the supply current should be less than 60% of this maximum current.

*21: Temperature of the cooling side of thermoelectric cooler

*22: Temperature of the heat radiating side of thermoelectric cooler

*23: This is a theoretical heat absorption level that offsets the temperature difference in the thermoelectric cooler when the maximum current is supplied to the unit.

S7031-0906S/-0907S

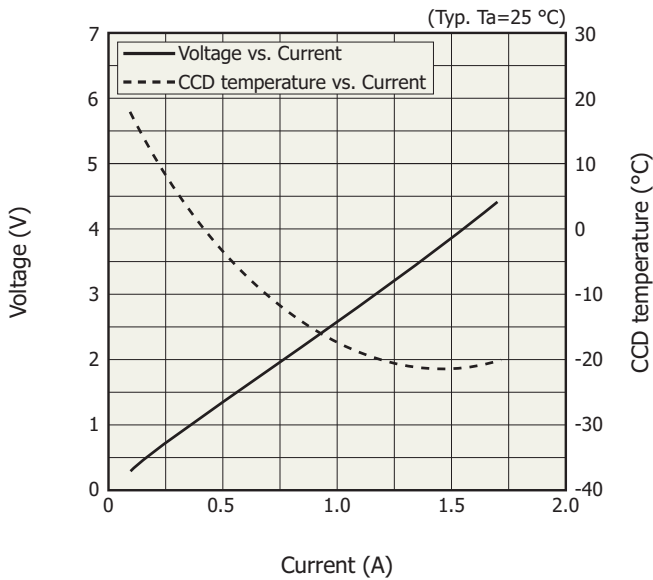

KMPDB0178EA

S7031-1006S/-1007S

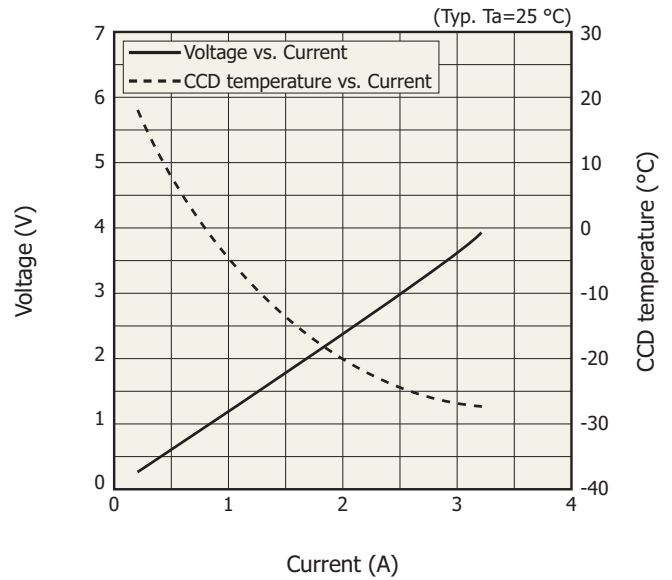

KMPDB0179EA

Specifications of built-in temperature sensor

A thermistor chip is built in the same package with a CCD chip, and the CCD chip temperature can be monitored with it. A relation between the thermistor resistance and absolute temperature is expressed by the following equation.

$$R_{T1} = R_{T2} \times \exp \left(B_{T1/T2} \left(\frac{1}{T1} - \frac{1}{T2} \right) \right)$$

R_{T1} : Resistance at absolute temperature $T1$ [K]

R_{T2} : Resistance at absolute temperature $T2$ [K]

$B_{T1/T2}$: B constant [K]

The characteristics of the thermistor used are as follows.

$R_{298} = 10 \text{ k}\Omega$

$B_{298/323} = 3450 \text{ K}$

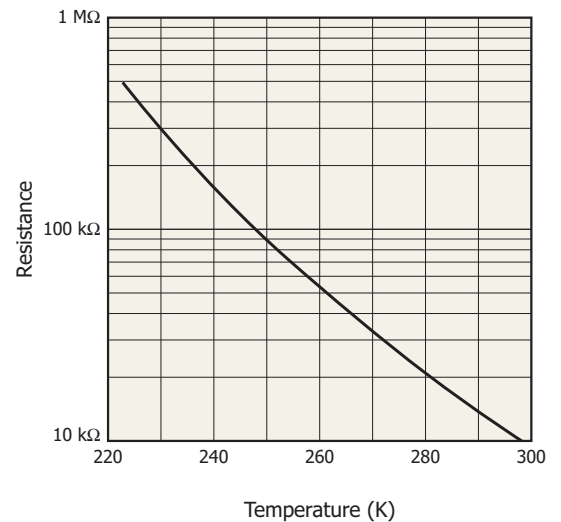

KMPDB0111EB

⚠ Precaution for use (electrostatic countermeasures)

- Handle these sensors with bare hands or wearing cotton gloves. In addition, wear anti-static clothing or use a wrist band with an earth ring, in order to prevent electrostatic damage due to electrical charges from friction.
- Avoid directly placing these sensors on a work-desk or work-bench that may carry an electrostatic charge.
- Provide ground lines or ground connection with the work-floor, work-desk and work-bench to allow static electricity to discharge.
- Ground the tools used to handle these sensors, such as tweezers and soldering irons.

It is not always necessary to provide all the electrostatic measures stated above. Implement these measures according to the amount of damage that occurs.

⚠ Element cooling/heating temperature incline rate

When cooling the CCD by an externally attached cooler, set the cooler operation so that the temperature gradient (rate of temperature change) for cooling or allowing the CCD to warm back is less than 5 K/minute.

Multichannel detector heads C7040, C7041

⚠ Features

- ➔ **C7040: for S7030 series**
C7041: for S7031 series
- ➔ **Area scanning or full line-binning operation**
- ➔ **Readout frequency: 250 kHz**
- ➔ **Readout noise: 20 e⁻ rms**
- ➔ **ΔT=50 °C (ΔT changes by cooling method.)**



Input	Symbol	Value
Supply voltage	VD1	+5 Vdc, 200 mA
	VA1+	+15 Vdc, +100 mA
	VA1-	-15 Vdc, -100 mA
	VA2	+24 Vdc, 30 mA
	VD2	+5 Vdc, 30 mA (C7041)
	Vp	+5 Vdc, 2.5 A (C7041)
	VF	+12 Vdc, 100 mA (C7041)
Master start	φms	HCMOS logic compatible
Master clock	φmc	HCMOS logic compatible, 1 MHz

Information described in this material is current as of January, 2011. Product specifications are subject to change without prior notice due to improvements or other reasons. Before assembly into final products, please contact us for the delivery specification sheet to check the latest information.

Type numbers of products listed in the delivery specification sheets or supplied as samples may have a suffix "(X)" which means preliminary specifications or a suffix "(Z)" which means developmental specifications.

The product warranty is valid for one year after delivery and is limited to product repair or replacement for defects discovered and reported to us within that one year period. However, even if within the warranty period we accept absolutely no liability for any loss caused by natural disasters or improper product use. Copying or reprinting the contents described in this material in whole or in part is prohibited without our prior permission.