

The RF MOSFET Line  
**RF Power Field Effect Transistors**  
N-Channel Enhancement-Mode Lateral MOSFETs

Designed for PCN and PCS base station applications with frequencies from 1.9 to 2.0 GHz. Suitable for TDMA, CDMA and multicarrier amplifier applications.

- Typical 2-Carrier N-CDMA Performance for  $V_{DD} = 26$  Volts,  $I_{DQ} = 850$  mA,  $P_{out} = 18$  Watts Avg.,  $f_1 = 1960$  MHz,  $f_2 = 1962.5$  MHz IS-95 CDMA (Pilot, Sync, Paging, Traffic Codes 8 Through 13) 1.2288 MHz Channel Bandwidth Carrier. Adjacent Channels Measured over a 30 kHz Bandwidth at  $f_1 - 885$  KHz and  $f_2 + 885$  kHz. Distortion Products Measured over 1.2288 MHz Bandwidth at  $f_1 - 2.5$  MHz and  $f_2 + 2.5$  MHz. Peak/Avg. = 9.8 dB @ 0.01% Probability on CCDF.  
Output Power — 18 Watts Avg.  
Power Gain — 13.0 dB  
Efficiency — 23%  
ACPR — -51 dB  
IM3 — -36.5 dBc
- Internally Matched, Controlled Q, for Ease of Use
- High Gain, High Efficiency and High Linearity
- Integrated ESD Protection
- Designed for Maximum Gain and Insertion Phase Flatness
- Capable of Handling 5:1 VSWR, @ 26 Vdc, 1.93 GHz, 90 Watts CW Output Power
- Excellent Thermal Stability
- Characterized with Series Equivalent Large-Signal Impedance Parameters
- Available in Tape and Reel. R3 Suffix = 250 Units per 56 mm, 13 Inch Reel.
- Available with Low Gold Plating Thickness on Leads. L Suffix Indicates 40 $\mu$ " Nominal.

**MRF19085**  
**MRF19085R3**  
**MRF19085SR3**  
**MRF19085LSR3**

**1990 MHz, 90 W, 26 V**  
**LATERAL N-CHANNEL**  
**RF POWER MOSFETs**

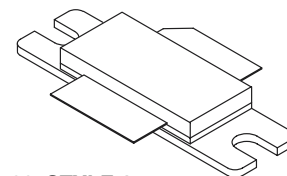

**CASE 465-06, STYLE 1**  
**NI-780**  
**MRF19085**

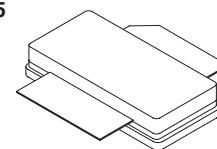

**CASE 465A-06, STYLE 1**  
**NI-780S**  
**MRF19085SR3, MRF19085LSR3**

**MAXIMUM RATINGS**

Rating	Symbol	Value	Unit
Drain-Source Voltage	$V_{DSS}$	65	Vdc
Gate-Source Voltage	$V_{GS}$	-0.5, +15	Vdc
Total Device Dissipation @ $T_C = 25^\circ\text{C}$ Derate above $25^\circ\text{C}$	$P_D$	273 1.56	Watts $\text{W}/^\circ\text{C}$
Storage Temperature Range	$T_{stg}$	-65 to +200	$^\circ\text{C}$
Operating Junction Temperature	$T_J$	200	$^\circ\text{C}$

**ESD PROTECTION CHARACTERISTICS**

Test Conditions	Class
Human Body Model	1 (Minimum)
Machine Model	M3 (Minimum)

**THERMAL CHARACTERISTICS**

Characteristic	Symbol	Max	Unit
Thermal Resistance, Junction to Case	$R_{\theta JC}$	0.64	$^\circ\text{C}/\text{W}$

NOTE - **CAUTION** - MOS devices are susceptible to damage from electrostatic charge. Reasonable precautions in handling and packaging MOS devices should be observed.

**ELECTRICAL CHARACTERISTICS** ( $T_C = 25^\circ\text{C}$  unless otherwise noted)

Characteristic	Symbol	Min	Typ	Max	Unit
----------------	--------	-----	-----	-----	------

**OFF CHARACTERISTICS**

Drain–Source Breakdown Voltage ( $V_{GS} = 0\text{ Vdc}$ , $I_D = 100\ \mu\text{Adc}$ )	$V_{(BR)DSS}$	65	—	—	Vdc
Zero Gate Voltage Drain Current ( $V_{DS} = 26\text{ Vdc}$ , $V_{GS} = 0\text{ Vdc}$ )	$I_{DSS}$	—	—	10	$\mu\text{Adc}$
Gate–Source Leakage Current ( $V_{GS} = 5\text{ Vdc}$ , $V_{DS} = 0\text{ Vdc}$ )	$I_{GSS}$	—	—	1	$\mu\text{Adc}$

**ON CHARACTERISTICS (DC)**

Gate Threshold Voltage ( $V_{DS} = 10\text{ Vdc}$ , $I_D = 200\ \mu\text{Adc}$ )	$V_{GS(th)}$	2	—	4	Vdc
Gate Quiescent Voltage ( $V_{DS} = 26\text{ Vdc}$ , $I_D = 850\text{ mAdc}$ )	$V_{GS(Q)}$	2.5	3.5	4.5	Vdc
Drain–Source On–Voltage ( $V_{GS} = 10\text{ Vdc}$ , $I_D = 2\text{ Adc}$ )	$V_{DS(on)}$	—	0.18	0.210	Vdc
Forward Transconductance ( $V_{DS} = 10\text{ Vdc}$ , $I_D = 2\text{ Adc}$ )	$g_{fs}$	—	6	—	S

**DYNAMIC CHARACTERISTICS**

Reverse Transfer Capacitance (1) ( $V_{DS} = 26\text{ Vdc}$ , $V_{GS} = 0$ , $f = 1.0\text{ MHz}$ )	$C_{rss}$	—	3.6	—	pF
--	-----------	---	-----	---	----

**FUNCTIONAL TESTS** (In Motorola Test Fixture, 50 ohm system) 2–Carrier N–CDMA, 1.2288 MHz Channel Bandwidth Carriers.  
Peak/Avg. Ratio = 9.8 dB @ 0.01% Probability on CCDF.

Common–Source Amplifier Power Gain ( $V_{DD} = 26\text{ Vdc}$ , $P_{out} = 18\text{ W Avg.}$ , $I_{DQ} = 850\text{ mA}$ , $f_1 = 1930\text{ MHz}$ , $f_2 = 1932.5\text{ MHz}$ and $f_1 = 1987.5\text{ MHz}$ , $f_2 = 1990\text{ MHz}$ )	$G_{ps}$	12	13	—	dB
Drain Efficiency ( $V_{DD} = 26\text{ Vdc}$ , $P_{out} = 18\text{ W Avg.}$ , $I_{DQ} = 850\text{ mA}$ , $f_1 = 1930\text{ MHz}$ , $f_2 = 1932.5\text{ MHz}$ and $f_1 = 1987.5\text{ MHz}$ , $f_2 = 1990\text{ MHz}$ )	$\eta$	21	23	—	%
3rd Order Intermodulation Distortion ( $V_{DD} = 26\text{ Vdc}$ , $P_{out} = 18\text{ W Avg.}$ , $I_{DQ} = 850\text{ mA}$ , $f_1 = 1930\text{ MHz}$ , $f_2 = 1932.5\text{ MHz}$ and $f_1 = 1987.5\text{ MHz}$ , $f_2 = 1990\text{ MHz}$ ); IM3 measured over 1.2288 MHz bandwidth @ $f_1 - 2.5\text{ MHz}$ and $f_2 = +2.5\text{ MHz}$ )	IMD	—	–36.5	–35	dBc
Adjacent Channel Power Ratio ( $V_{DD} = 26\text{ Vdc}$ , $P_{out} = 18\text{ W Avg.}$ , $I_{DQ} = 850\text{ mA}$ , $f_1 = 1930\text{ MHz}$ , $f_2 = 1932.5\text{ MHz}$ and $f_1 = 1987.5\text{ MHz}$ , $f_2 = 1990\text{ MHz}$ ); ACPR measured over 30 kHz bandwidth @ $f_1 - 885\text{ MHz}$ and $f_2 = +885\text{ MHz}$ )	ACPR	—	–51	–48	dBc
Input Return Loss ( $V_{DD} = 26\text{ Vdc}$ , $P_{out} = 18\text{ W Avg.}$ , $I_{DQ} = 850\text{ mA}$ , $f_1 = 1930\text{ MHz}$ , $f_2 = 1932.5\text{ MHz}$ and $f_1 = 1987.5\text{ MHz}$ , $f_2 = 1990\text{ MHz}$ )	IRL	—	–12	–9	dB
Output Mismatch Stress ( $V_{DD} = 26\text{ Vdc}$ , $P_{out} = 90\text{ W CW}$ , $I_{DQ} = 850\text{ mA}$ , $f = 1930\text{ MHz}$ , VSWR $= 5:1$ , All Phase Angles at Frequency of Tests)	$\Psi$	No Degradation In Output Power Before and After Test			

(1) Part is internally matched both on input and output.

**ELECTRICAL CHARACTERISTICS — continued** ( $T_C = 25^\circ\text{C}$  unless otherwise noted)

Characteristic	Symbol	Min	Typ	Max	Unit
<b>FUNCTIONAL TESTS</b> (In Motorola Test Fixture)					
Two-Tone Common-Source Amplifier Power Gain ( $V_{DD} = 26\text{ Vdc}$ , $P_{out} = 90\text{ W PEP}$ , $I_{DQ} = 850\text{ mA}$ , $f = 1930\text{ MHz}$ and $1990\text{ MHz}$ , Tone Spacing = $100\text{ kHz}$ )	$G_{ps}$	—	13	—	dB
Two-Tone Drain Efficiency ( $V_{DD} = 26\text{ Vdc}$ , $P_{out} = 90\text{ W PEP}$ , $I_{DQ} = 850\text{ mA}$ , $f = 1930\text{ MHz}$ and $1990\text{ MHz}$ , Tone Spacing = $100\text{ kHz}$ )	$\eta$	—	36	—	%
3rd Order Intermodulation Distortion ( $V_{DD} = 26\text{ Vdc}$ , $P_{out} = 90\text{ W PEP}$ , $I_{DQ} = 850\text{ mA}$ , $f = 1930\text{ MHz}$ and $1990\text{ MHz}$ , Tone Spacing = $100\text{ kHz}$ )	IMD	—	-31	—	dBc
Input Return Loss ( $V_{DD} = 26\text{ Vdc}$ , $P_{out} = 90\text{ W PEP}$ , $I_{DQ} = 850\text{ mA}$ , $f = 1930\text{ MHz}$ and $1990\text{ MHz}$ , Tone Spacing = $100\text{ kHz}$ )	IRL	—	-12	—	dB
$P_{out}$ : 1 dB Compression Point ( $V_{DD} = 26\text{ Vdc}$ , $I_{DQ} = 850\text{ mA}$ , $f = 1990\text{ MHz}$ )	P1dB	—	90	—	W

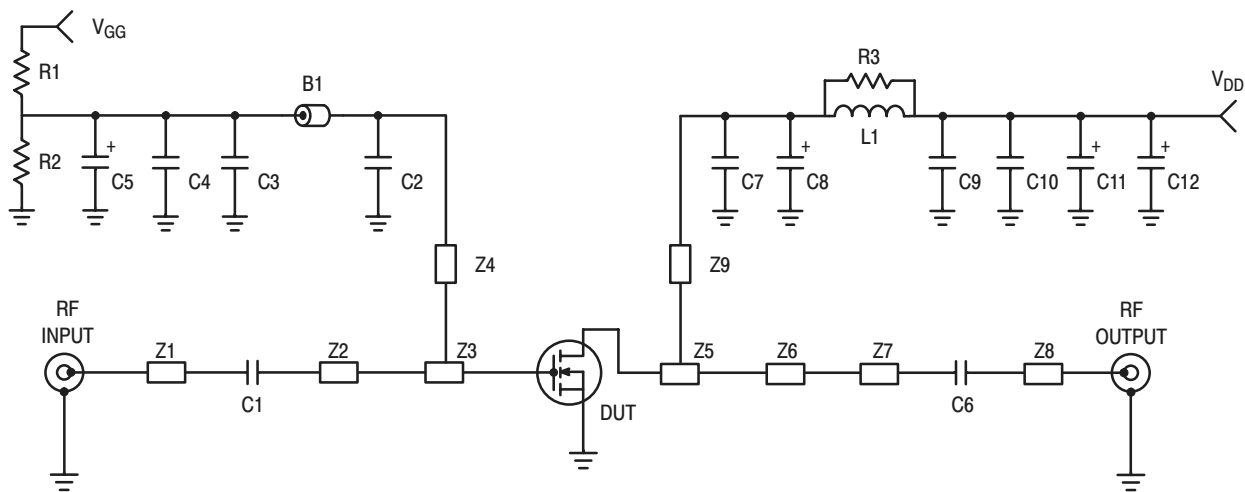

Figure 1. 1930 – 1990 MHz 2-Carrier N-CDMA Test Circuit Schematic

Table 1. 1930 – 1990 MHz 2-Carrier N-CDMA Test Circuit Component Designations and Values

Part	Description	Value, P/N or DWG	Manufacturer
B1	Short Ferrite Bead	2743019447	Fair Rite
C1	51 pF Chip Capacitor	100B510JCA500X	ATC
C2, C7	5.1 pF Chip Capacitors	100B5R1JCA500X	ATC
C3, C9	1000 pF Chip Capacitors	100B102JCA500X	ATC
C4, C10	0.1 $\mu$ F Chip Capacitors	CDR33BX104AKWS	Kemet
C5	0.1 $\mu$ F Tantalum Surface Mount Capacitor	T491C105M050	Kemet
C6	10 pF Chip Capacitor	100B100JCA500X	ATC
C8	10 $\mu$ F Tantalum Surface Mount Capacitor	T495X106K035AS4394	Kemet
C11, C12	22 $\mu$ F Tantalum Surface Mount Capacitors	T491X226K035AS4394	Kemet
L1	1 Turn, 20 AWG, 0.100" ID		Motorola
N1, N2	Type N Flange Mounts	3052-1648-10	Omni Spectra
R1	1.0 k $\Omega$ , 1/8 W Chip Resistor		
R2	220 k $\Omega$ , 1/8 W Chip Resistor		
R3	10 $\Omega$ , 1/8 W Chip Resistor		
Z1	Microstrip	0.750" x 0.0840"	
Z2	Microstrip	1.090" x 0.0840"	
Z3	Microstrip	0.400" x 1.400"	
Z4	Microstrip	0.520" x 0.050"	
Z5	Microstrip	0.540" x 1.133"	
Z6	Microstrip	0.400" x 0.140"	
Z7	Microstrip	0.555" x 0.0840"	
Z8	Microstrip	0.720" x 0.0840"	
Z9	Microstrip	0.560" x 0.070"	
Board	0.030" Glass Teflon <sup>®</sup>	GX-0300-55-22, $\epsilon_r = 2.55$	Keene
PCB	Etched Circuit Boards	MRF19085 Rev. 4	CMR

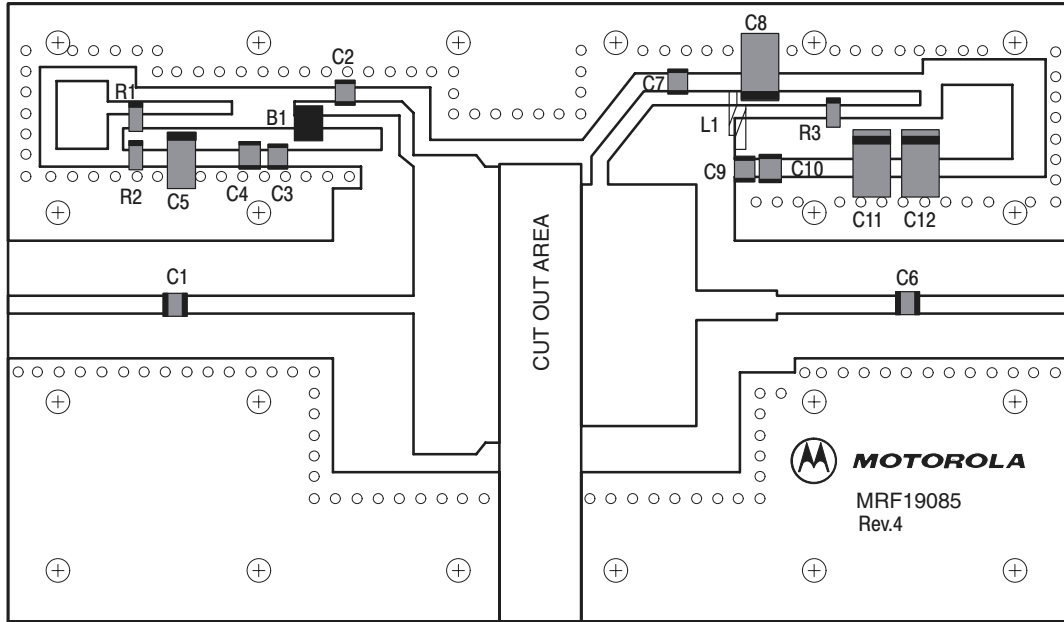
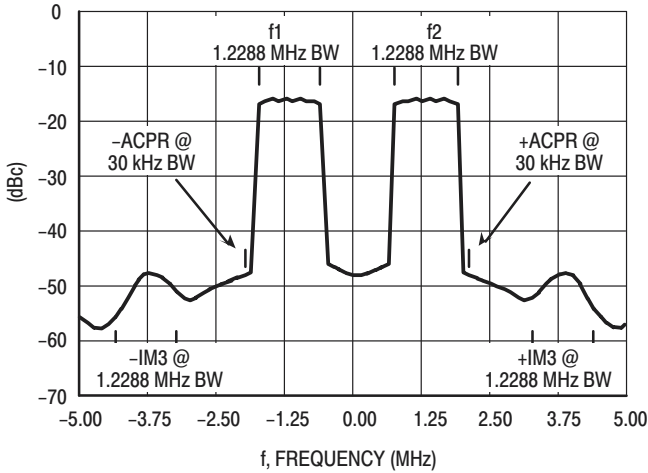
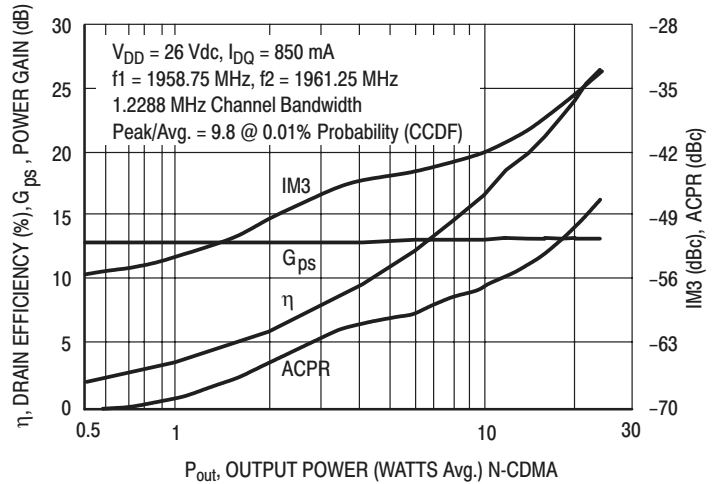

Figure 2. 1930 – 1990 MHz 2-Carrier N-CDMA Test Circuit Component Layout

## TYPICAL CHARACTERISTICS



**Figure 3. 2-Carrier N-CDMA Spectrum**



**Figure 4. 2-Carrier N-CDMA ACPR, IM3, Power Gain and Drain Efficiency versus Output Power**

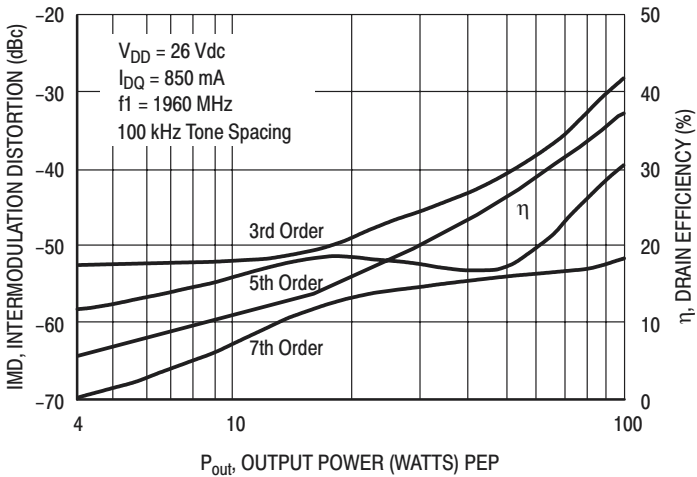

**Figure 5. Intermodulation Distortion Products versus Output Power**

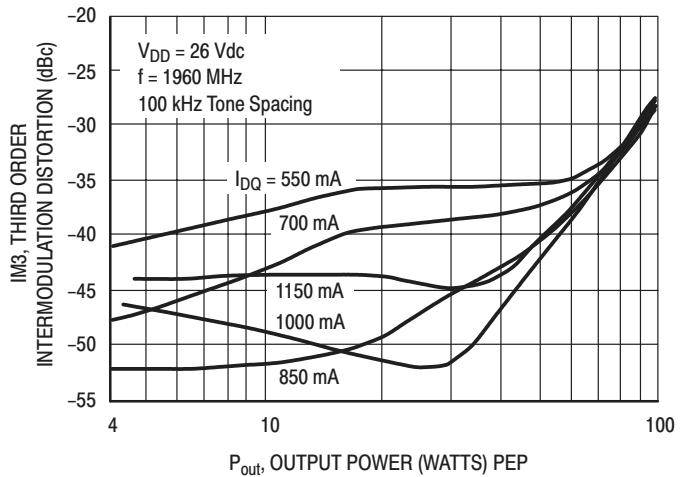

**Figure 6. Third Order Intermodulation Distortion versus Output Power and  $I_{DQ}$**

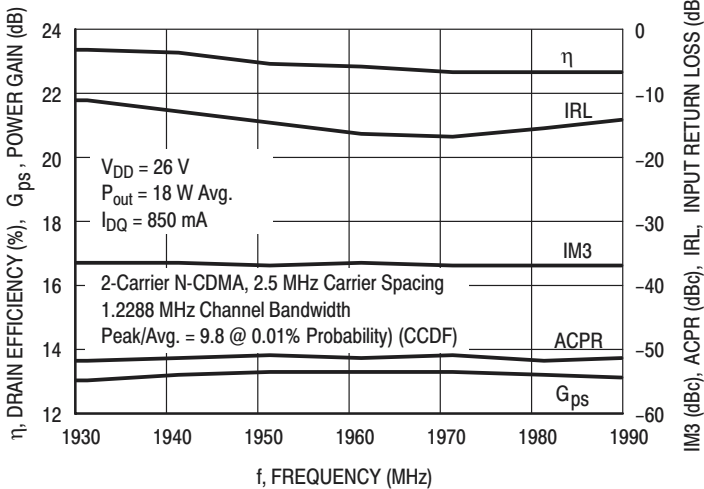

**Figure 7. 2-Carrier N-CDMA Broadband Performance**

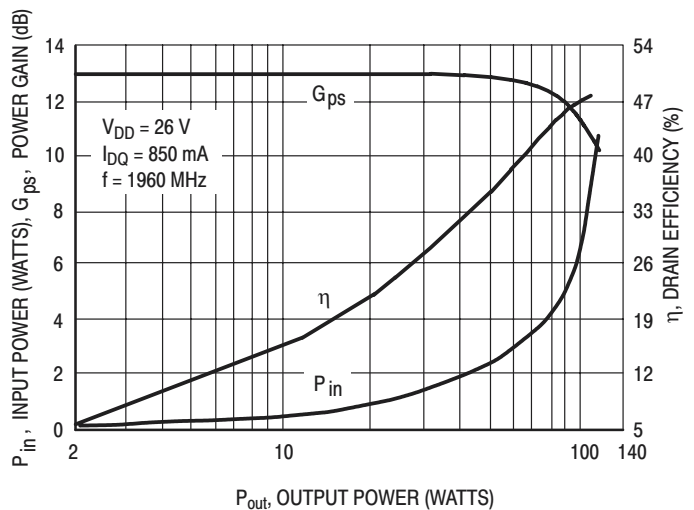

**Figure 8. CW Performance**

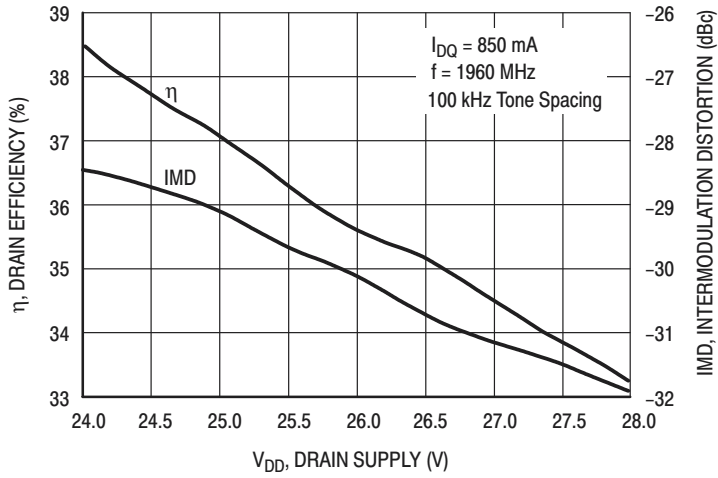

Figure 9. Two-Tone Intermodulation Distortion and Drain Efficiency versus Drain Supply

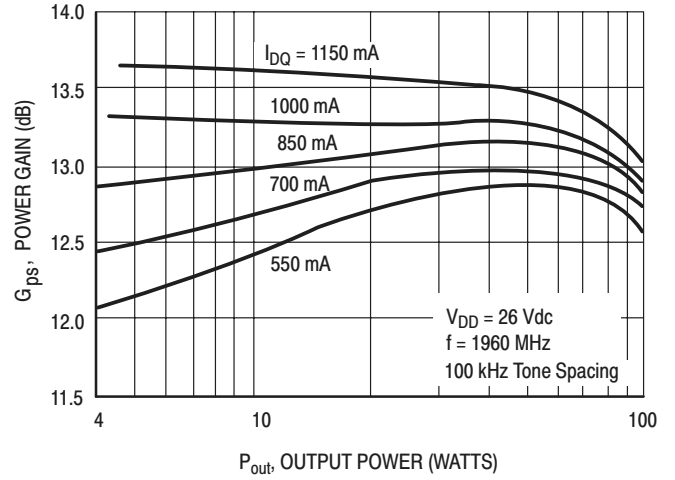

Figure 10. Two-Tone Power Gain versus Output Power

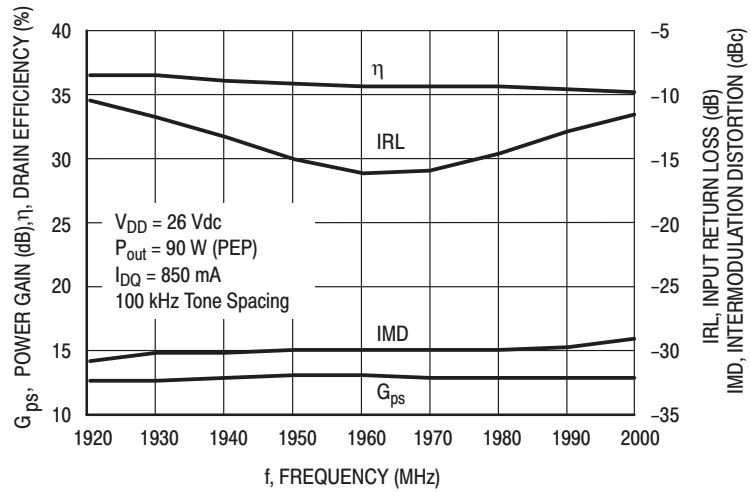
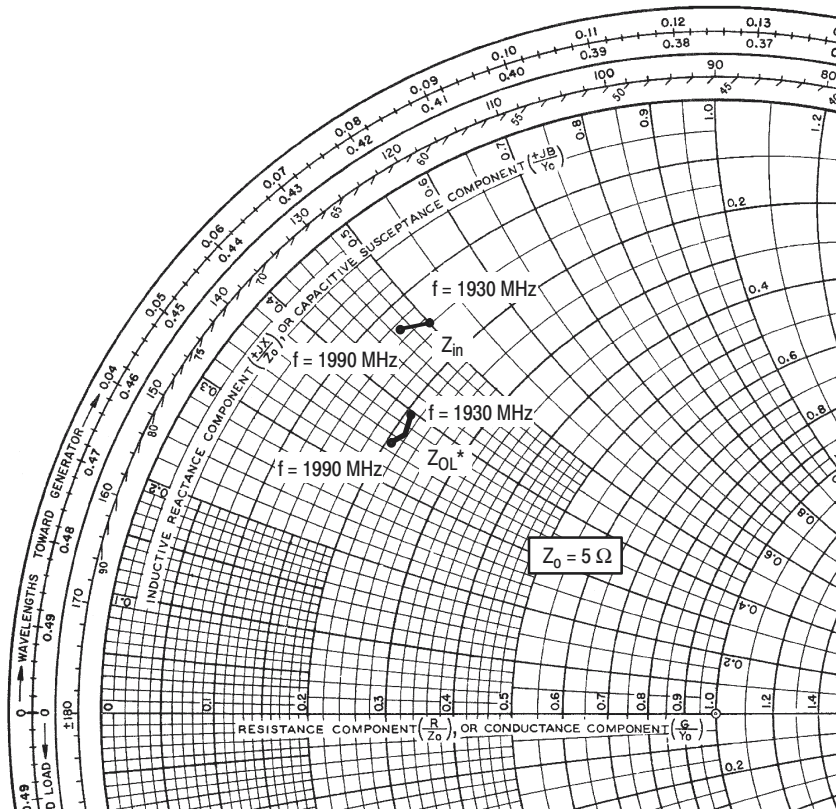

Figure 11. Two-Tone Broadband Performance



$V_{DD} = 26 \text{ V}$ ,  $I_{DQ} = 850 \text{ mA}$ ,  $P_{out} = 18 \text{ W Avg.}$

f MHz	$Z_{in}$ $\Omega$	$Z_{OL}^*$ $\Omega$
1930	$0.75 + j2.50$	$1.05 + j1.95$
1960	$0.70 + j2.40$	$1.10 + j1.85$
1990	$0.65 + j2.35$	$1.05 + j1.75$

$Z_{in}$  = Complex conjugate of source impedance.

$Z_{OL}^*$  = Complex conjugate of the optimum load impedance at a given output power, voltage, IMD, bias current and frequency.

Note:  $Z_{OL}^*$  was chosen based on tradeoffs between gain, output power, drain efficiency and intermodulation distortion.

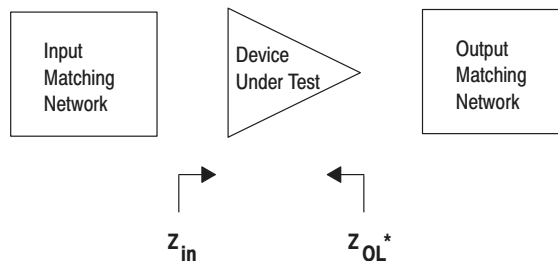

Figure 12. Series Equivalent Input and Output Impedance



# NOTES

# NOTES

## PACKAGE DIMENSIONS

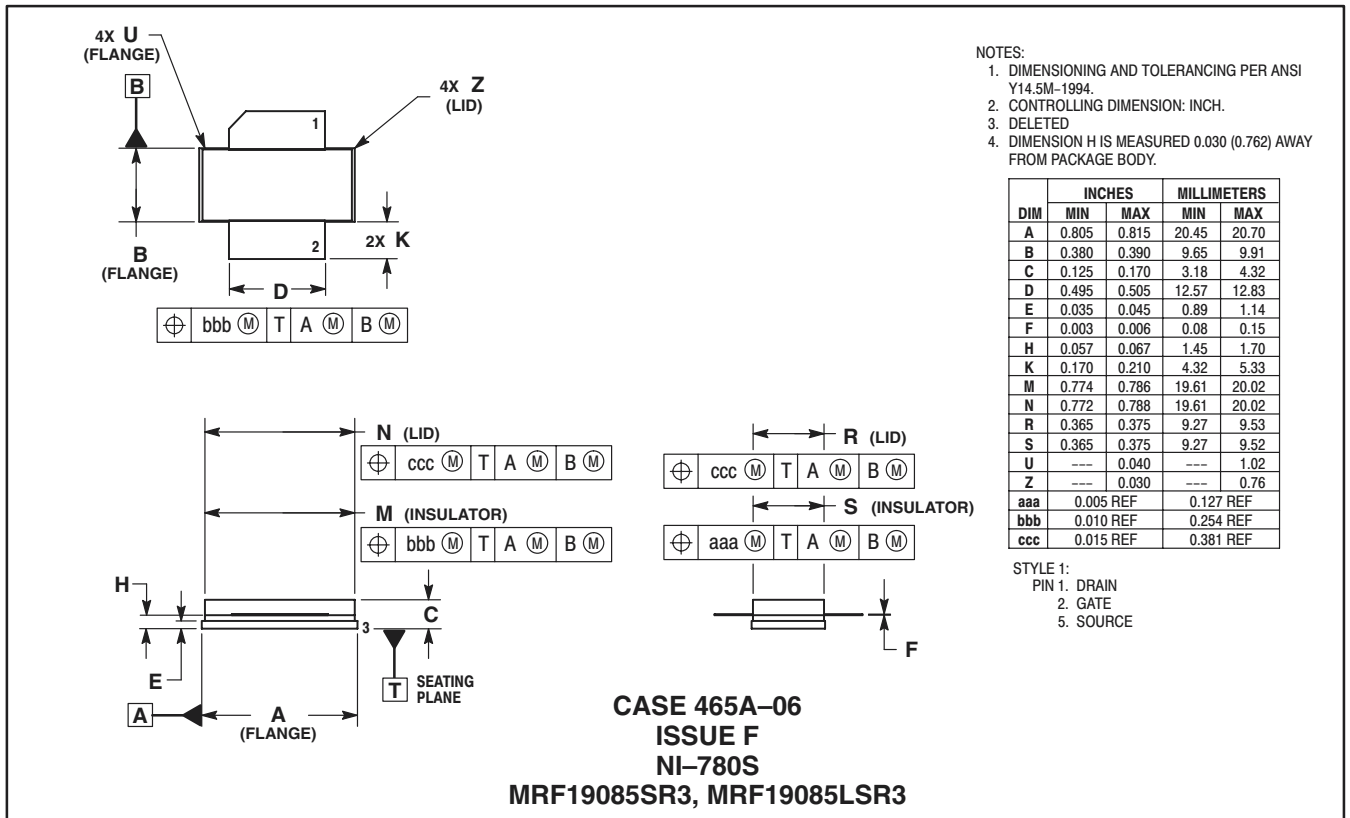
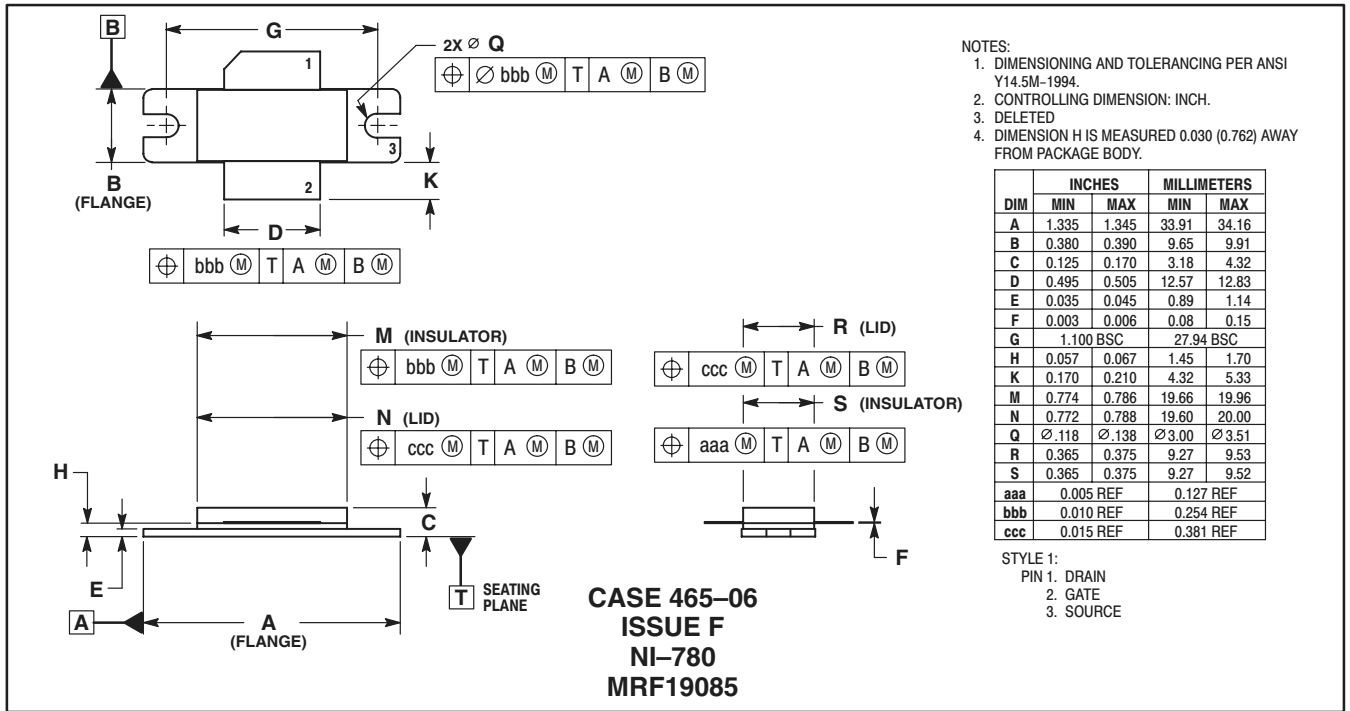

Motorola reserves the right to make changes without further notice to any products herein. Motorola makes no warranty, representation or guarantee regarding the suitability of its products for any particular purpose, nor does Motorola assume any liability arising out of the application or use of any product or circuit, and specifically disclaims any and all liability, including without limitation consequential or incidental damages. "Typical" parameters which may be provided in Motorola data sheets and/or specifications can and do vary in different applications and actual performance may vary over time. All operating parameters, including "Typicals" must be validated for each customer application by customer's technical experts. Motorola does not convey any license under its patent rights nor the rights of others. Motorola products are not designed, intended, or authorized for use as components in systems intended for surgical implant into the body, or other applications intended to support or sustain life, or for any other application in which the failure of the Motorola product could create a situation where personal injury or death may occur. Should Buyer purchase or use Motorola products for any such unintended or unauthorized application, Buyer shall indemnify and hold Motorola and its officers, employees, subsidiaries, affiliates, and distributors harmless against all claims, costs, damages, and expenses, and reasonable attorney fees arising out of, directly or indirectly, any claim of personal injury or death associated with such unintended or unauthorized use, even if such claim alleges that Motorola was negligent regarding the design or manufacture of the part. Motorola, Inc. Motorola, Inc. is an Equal Opportunity/Affirmative Action Employer. MOTOROLA and the  logo are registered in the US Patent & Trademark Office. All other product or service names are the property of their respective owners.

© Motorola, Inc. 2002.

**How to reach us:**

**USA/EUROPE/Locations Not Listed:** Motorola Literature Distribution; P.O. Box 5405, Denver, Colorado 80217. 1-303-675-2140 or 1-800-441-2447

**JAPAN:** Motorola Japan Ltd.; SPS, Technical Information Center, 3-20-1, Minami-Azabu. Minato-ku, Tokyo 106-8573 Japan. 81-3-3440-3569

**ASIA/PACIFIC:** Motorola Semiconductors H.K. Ltd.; Silicon Harbour Centre, 2 Dai King Street, Tai Po Industrial Estate, Tai Po, N.T., Hong Kong. 852-26668334

**Technical Information Center: 1-800-521-6274**

**HOME PAGE:** <http://www.motorola.com/semiconductors/>

