



FEATURES:

- AC-DC Constant current LED Driver
- Input range 90-277VAC/47-440Hz
- High Efficiency up to 89%
- Operating temperature -40 to 80°C
- Over Temperature Protection
- Open frame
- Power Factor Correction
- SCP, Over Current Protection



Models
Single output

Model	Max Output Power (W) *	Output Voltage Range (V)	Output Current (A)	Input Voltage (VAC/Hz)	Input Voltage (VDC)	Efficiency (%)
AMEOR60-50120AZ	60	36-50	1.2	90-277/47-440	120-390	89
AMEOR60-36170AZ	59.8	24-36	1.66	90-277/47-440	120-390	88
AMEOR60-24250AZ	60	12-24	2.5	90-277/47-440	120-390	87
AMEOR60-12500AZ	60	5-12	5	90-277/47-440	120-390	85

*Exceeding the maximum output power will permanently damage the converter

NOTE: All specifications in this datasheet are measured at an ambient temperature of 25°C, humidity<75%, nominal input voltage and at rated output load unless otherwise specified.

Input Specifications

Parameters	Conditions	Typical	Maximum	Units
Inrush current <2ms	115VAC	30		A
	230VAC	50		
Leakage current	115VAC	0.5		mA
	230VAC	0.75		
AC current	115VAC	0.67		A
	230VAC	0.33		
Power Factor	115VAC		0.99	
	230VAC		0.97	
External fuse			250V/1.5A	
Start up time		250		ms
Surge voltage	2sec		440	V

Output Specifications

Parameters	Conditions	Typical	Maximum	Units
Current accuracy		±3		%
Line regulation	LL-HL	±1		%
Load regulation	0-100% load	±3		%
Ripple & Noise *	20MHz Bandwidth	75		mV p-p
Hold-up time		90		ms
Current adjustment range		100-0		%
Minimum Load Voltage	See the models table			

* Tested with 0.1µF (M/C) or (C/C) and 10µF (E/C) parallel capacitors at the end.

Isolation Specifications

Parameters	Conditions	Typical	Rated	Units
Tested I/O voltage	3 sec/3.5mA		3000	VAC
Isolation Resistance		>1000		MΩ

General Specifications

Parameters	Conditions	Typical	Maximum	Units
Switching frequency		130		KHz
Over current protection		95-110% of Iout		

General Specifications (continued)

Parameters	Conditions	Typical	Maximum	Units
Over voltage protection		110% of Vout		
Short circuit protection		Continuous		
Short circuit restart		Auto recovery		
Over temperature protection		>105°C		
Operating temperature	With derating over 60°C	-40 to +80		°C
Maximum case temperature			100	°C
Storage temperature		-40 to +95		°C
Temperature coefficient		±0.02		% / °C
Cooling		Free air convection		
Humidity			95	% RH
Wires		UL1015 18AWG * 20CM		
Weight		220		g
Dimensions (L x H x W)		5.83 x 1.97 x 1.3 inches	148 x 50 x 33 mm	
MTBF		>400,000 hrs (MIL-HDBK-217F at +25°C)		

Environment Approval

Test	Parameters	Conditions
Shock	Wave form	Half sine wave
	Acceleration amplitude	5gn
	Bump duration	30 ms
	Converter operation	Before and after test, body mounted (on chassis)
	Number of bumps	18 (3 in each direction for every axis)
Vibration	Test mode	Sweep sine, 10-100Hz, speed 0.05Hz/s
	Displacement	1 mm
	Acceleration	3g, 3 loops 30min one cycle, 3h total, every axis tested
	Converter operation	Before and after test, body mounted (on chassis)

Dimensions

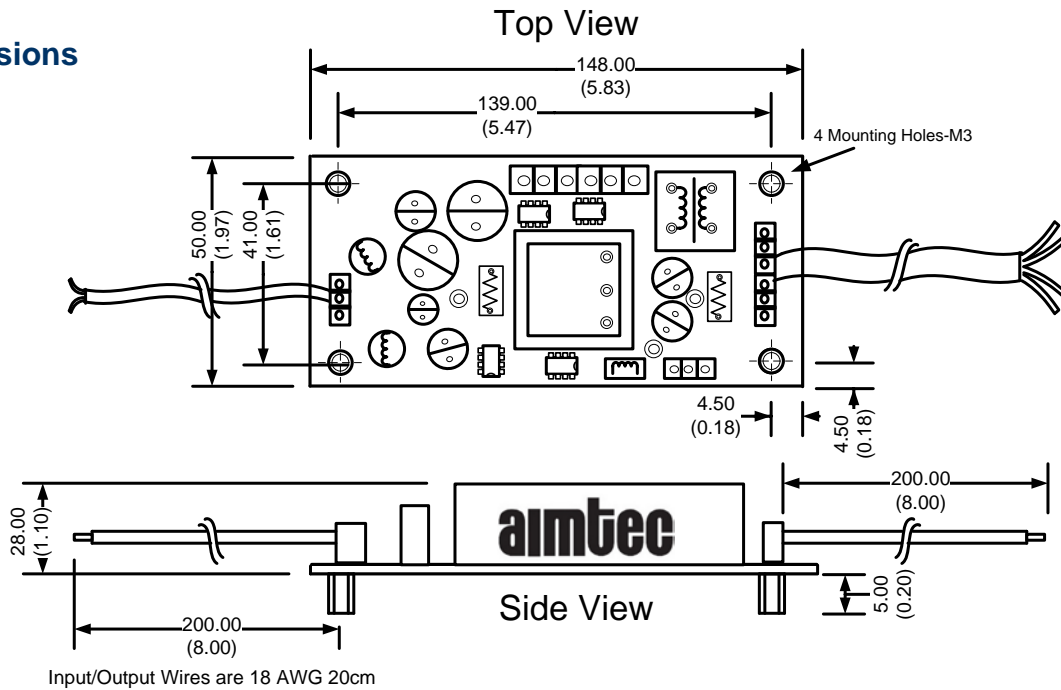

NOTE: to adjust the output current connect a 20K Ohm pot between blue and white wire

Application Circuit

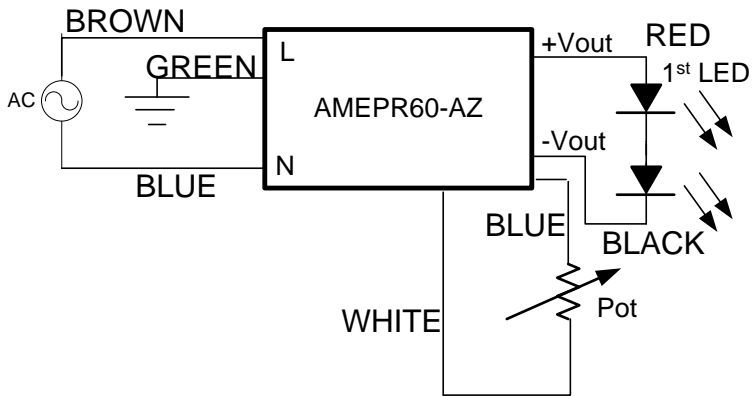

Model Number	Maximum Pot Value (kΩ)
AMEPR60-50120AZ	26.00
AMEPR60-36170AZ	16.95
AMEPR60-24250AZ	26.10
AMEPR60-12500AZ	34.10

Temperature graph

Free Air Convection

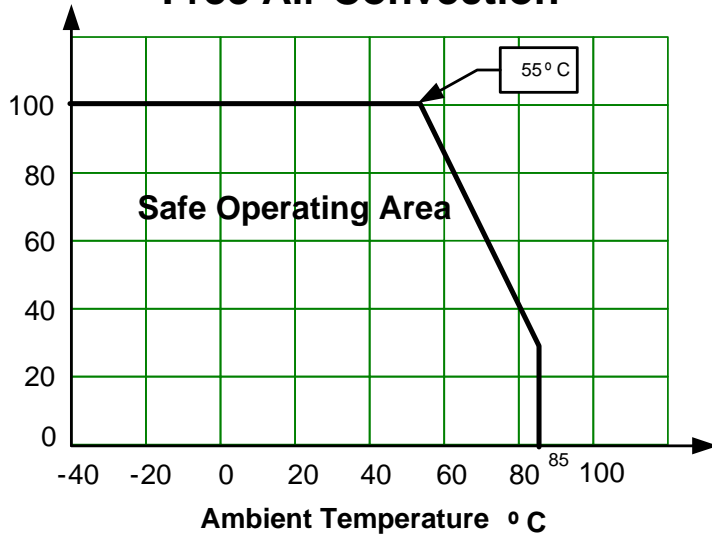

Efficiency Vs. Input Voltage & Output Current (Constant current load)

AMEOR60-50120AZ

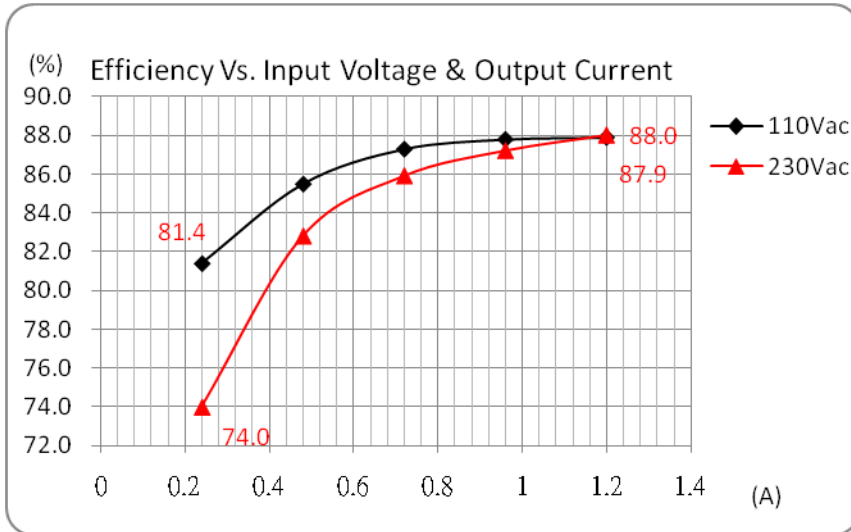

AMEOR60-36170AZ

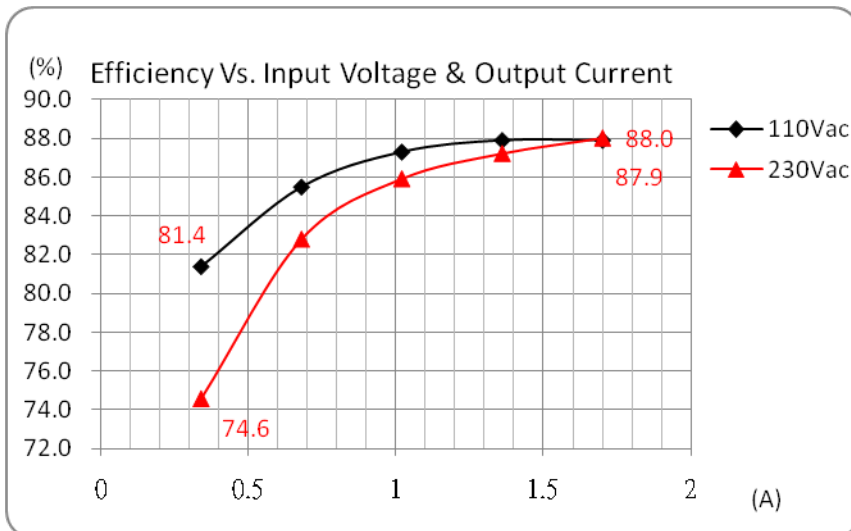

Efficiency Vs. Input Voltage & Output Current (Constant current load)
Continued

AMEOR60-24250AZ

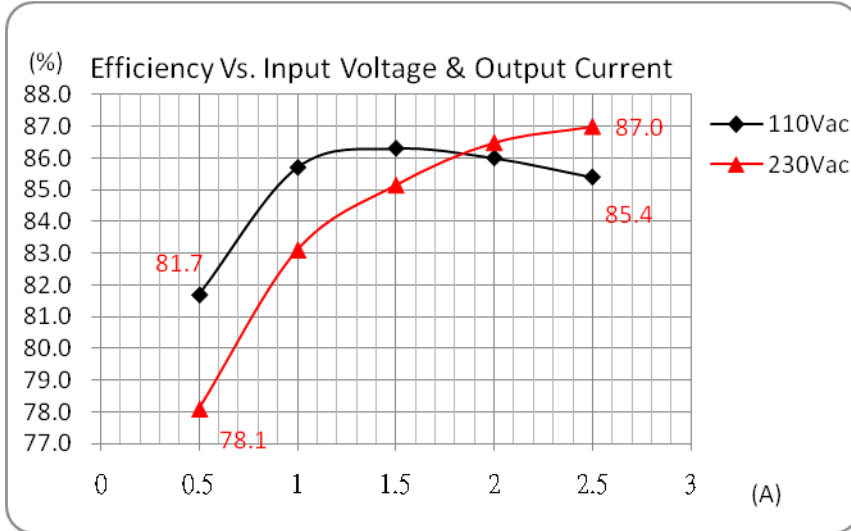

AMEOR60-12500AZ

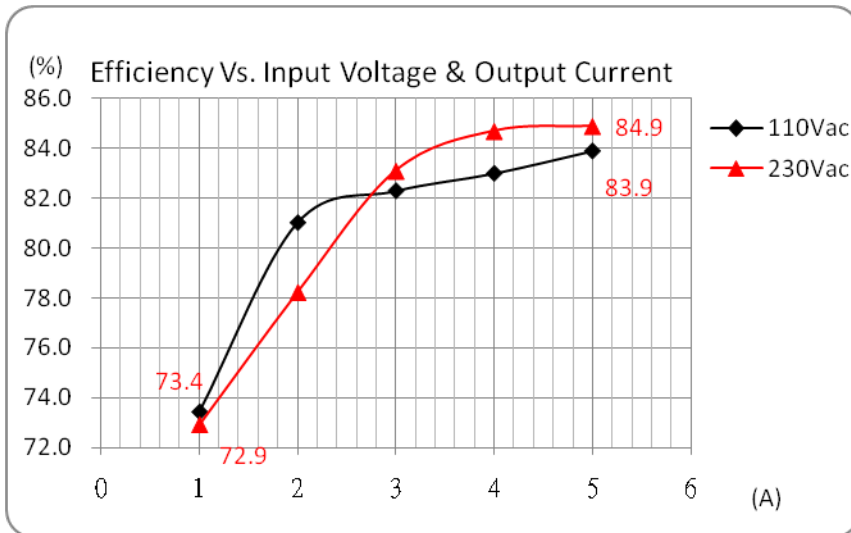

PFC Value vs. Output Load Current (constant current mode)

AMEOR60-50120AZ

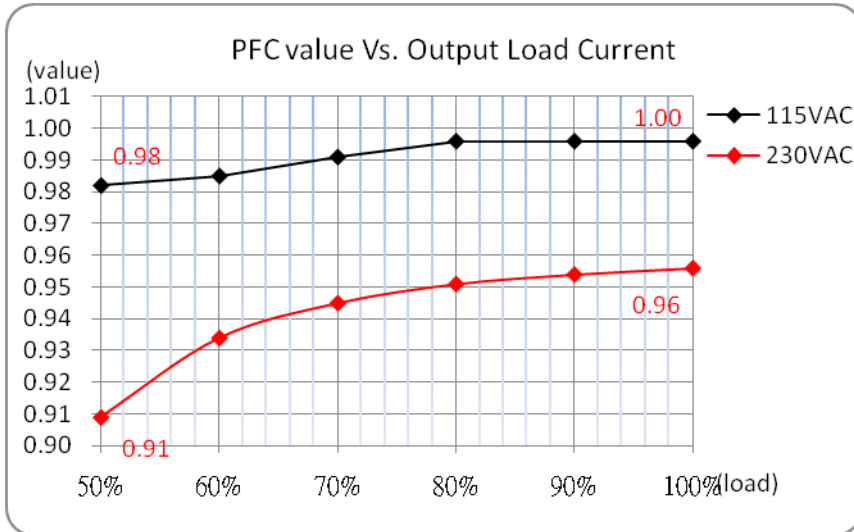

AMEOR60-36170AZ

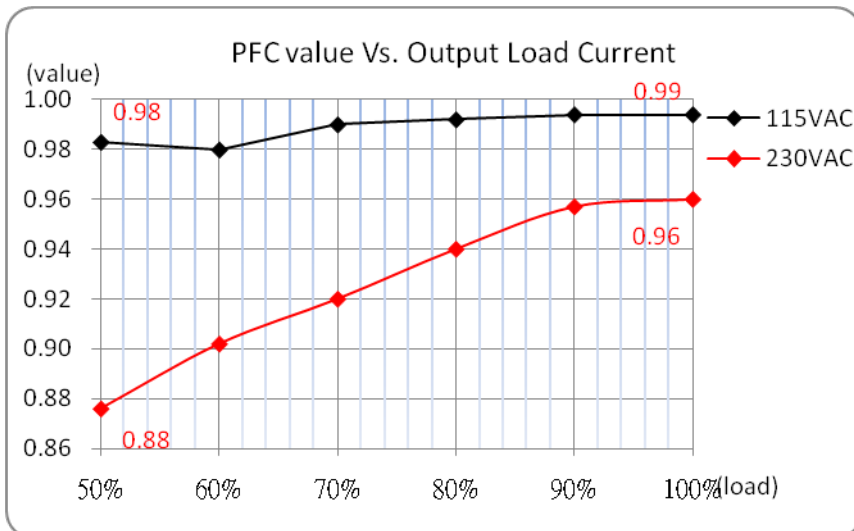

PFC Value vs. Output Load Current (constant current mode)
Continued

AMEOR60-24250AZ

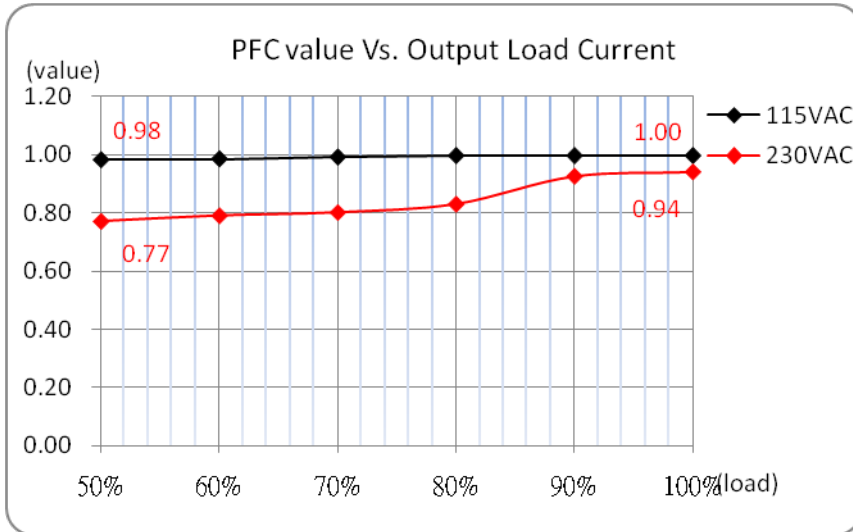

AMEOR60-12500AZ

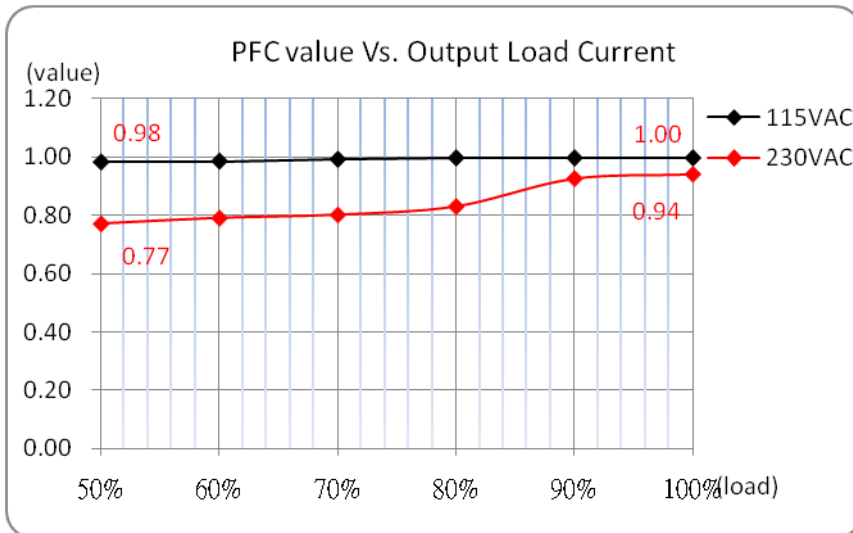

Constant Current vs. Constant Voltage Mode

AMEOR60-50120AZ

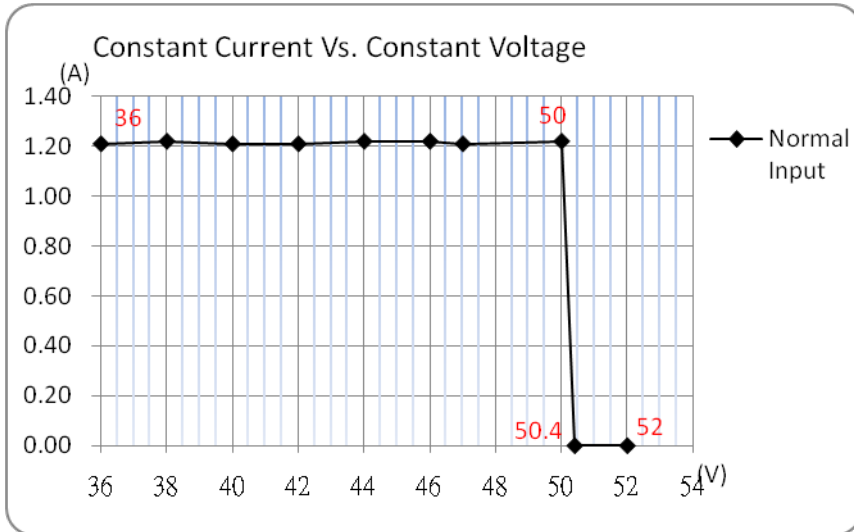

AMEOR60-36170AZ

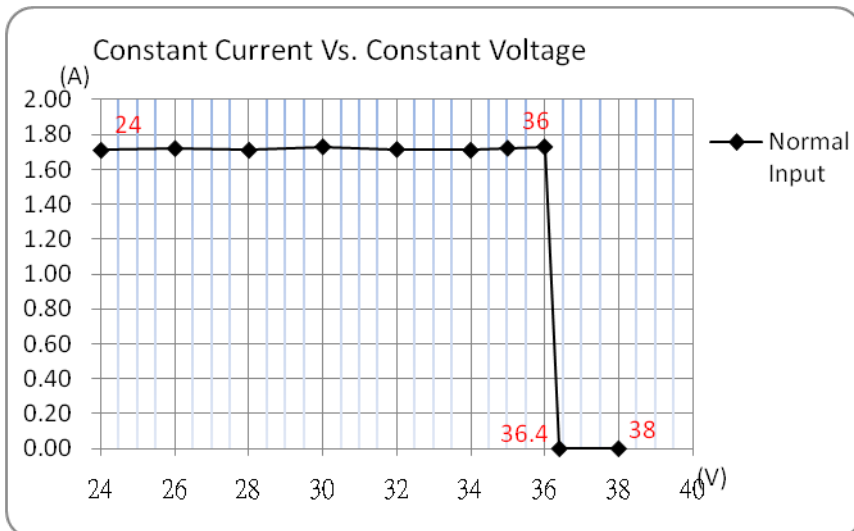

Constant Current vs. Constant Voltage Mode Continued

AMEOR60-24250AZ

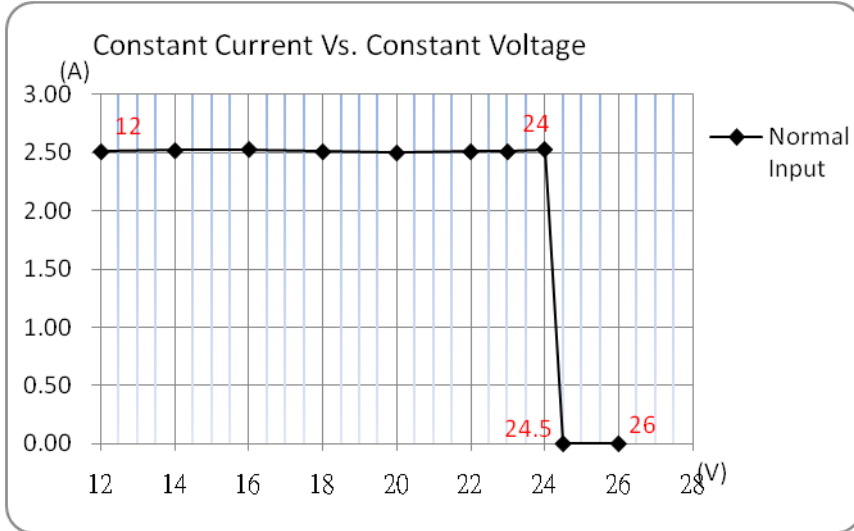

AMEOR60-12500AZ

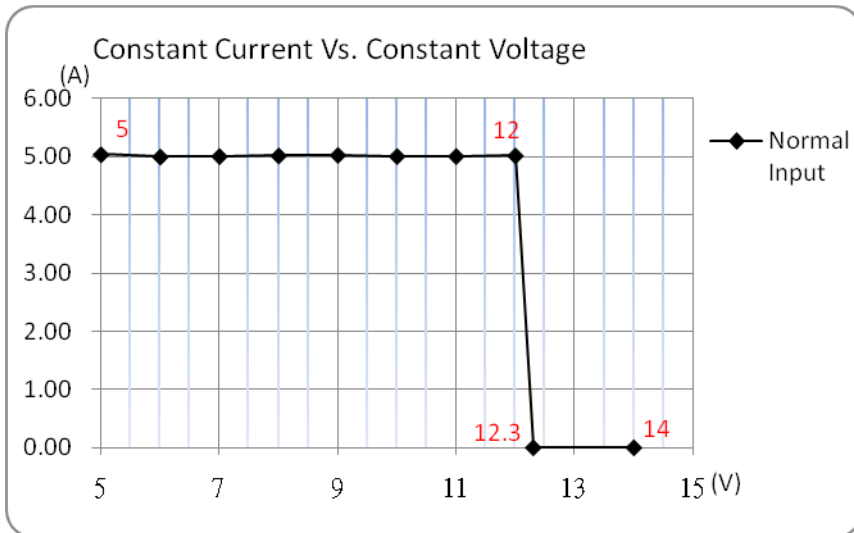

Dimming Control (Output Current vs. Radj)

AMEOR60-50120AZ

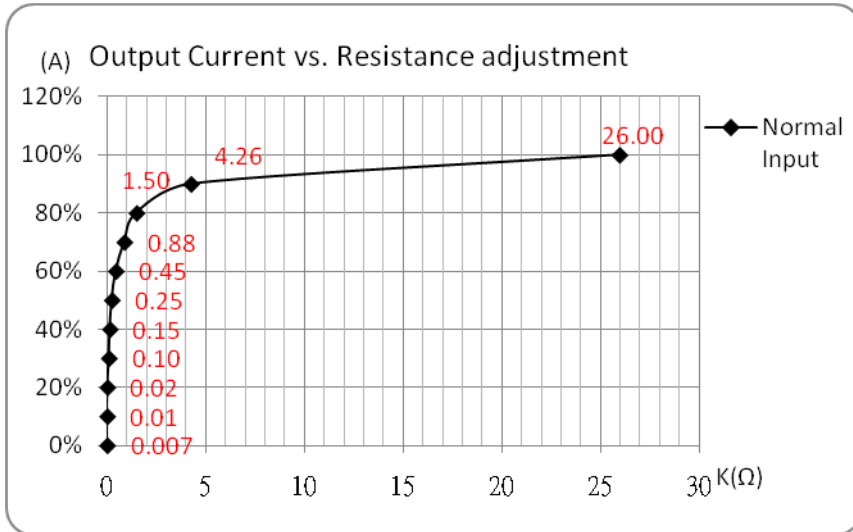

AMEOR60-36170AZ

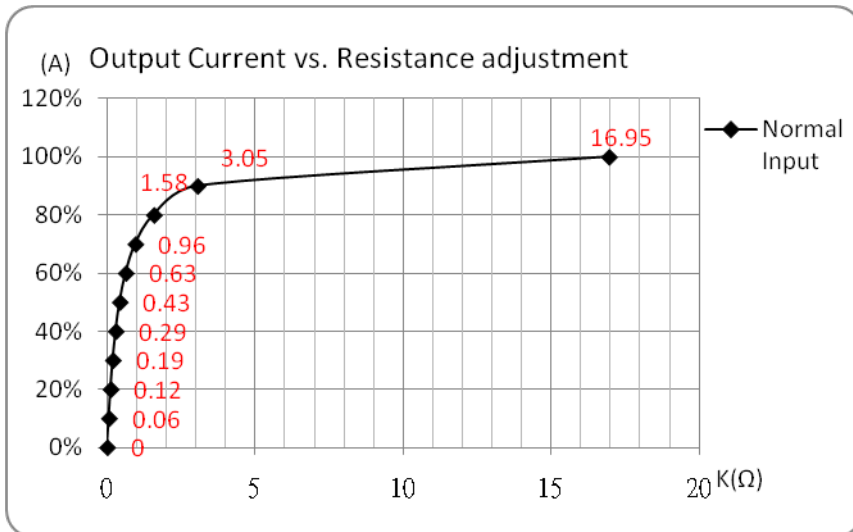

**Constant Current vs. Constant Voltage Mode
Continued**

AMEOR60-24250AZ

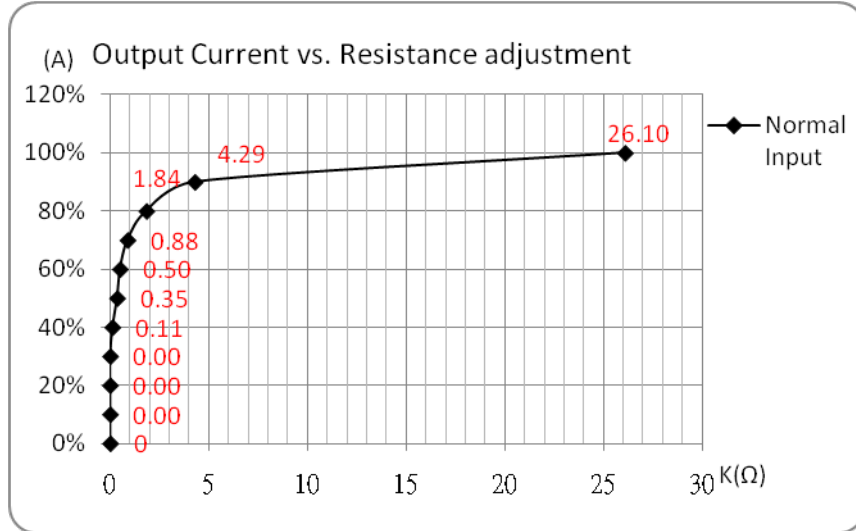

AMEOR60-12500AZ

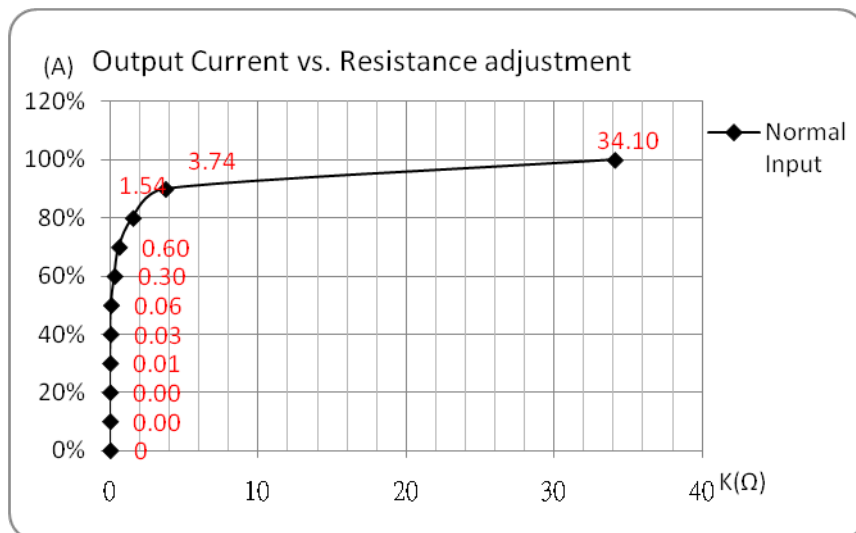

NOTE: **1.** Datasheets are updated as needed and as such, specifications are subject to change without notice. Once printed or downloaded, datasheets are no longer controlled by Aimtec; refer to www.aimtec.com for the most current product specifications. **2.** Product labels shown, including safety agency certifications on labels, may vary based on the date manufactured. **3.** Mechanical drawings and specifications are for reference only. **4.** All specifications are measured at an ambient temperature of 25°C, humidity<75%, nominal input voltage and at rated output load unless otherwise specified. **5.** Aimtec may not have conducted destructive testing or chemical analysis on all internal components and chemicals at the time of publishing this document. CAS numbers and other limited information are considered proprietary and may not be available for release. **6.** This product is not designed for use in critical life support systems, equipment used in hazardous environments, nuclear control systems or other such applications which necessitate specific safety and regulatory standards other the ones listed in this datasheet. **7.** Warranty is in accordance with Aimtec's standard Terms of Sale available at www.aimtec.com.