



Surface Mount Capacitors

- Solid & Organic Tantalum
- Multilayer Ceramic
- Solid Aluminum

www.kemet.com

KEMET
CHARGED.™

INDEX

SOLID TANTALUM CHIP CAPACITORS

	PAGE
GENERAL PERFORMANCE CHARACTERISTICS.....	3-14
T491 SERIES — INDUSTRIAL GRADE	15-19
T492 SERIES — CWR11 STYLE PER MIL-PRF-55365/8.....	20-21
T493 SERIES — MILITARY COTS	22-26
T494 SERIES — LOW ESR, INDUSTRIAL GRADE.....	27-30
T495 SERIES — LOW ESR, SURGE ROBUST	31-35
T496 SERIES — FAIL-SAFE WITH BUILT-IN FUSE	36-38
T498 SERIES — HIGH TEMPERATURE	39-40
T510 SERIES — HIGH CAPACITANCE-LOW ESR.....	41-42

CONDUCTIVE POLYMER CHIP CAPACITORS

	PAGE
GENERAL PERFORMANCE CHARACTERISTICS.....	43-49
T520 SERIES — KO-CAP POLYMER	50-53
T525 SERIES — KO-CAP POLYMER - HIGH TEMPERATURE.....	54-55
T530 SERIES — KO-CAP POLYMER - HIGH CAPACITANCE/ULTRA LOW ESR.....	56-57

ALUMINUM ORGANIC CAPACITORS

	PAGE
GENERAL PERFORMANCE CHARACTERISTICS.....	58-63
A700 SERIES	64-66

CERAMIC CHIP CAPACITORS

	PAGE
GENERAL PERFORMANCE CHARACTERISTICS.....	67-71
CERAMIC CHIP-STANDARD	72-76
CERAMIC CHIP-TIN-LEAD L TERMINATION.....	77
THICKNESS CODE REEL QUANTITY REFERENCE CHART	78
CERAMIC OPEN-MODE.....	79-80
CERAMIC HIGH VOLTAGE	81-84
CERAMIC CAPACITOR ARRAY	85-86
MIL-PRF-55681 ESTABLISHED RELIABILITY	87-91
MIL-PRF-55681 TAPE AND REEL QUANTITIES	91
LAND DIMENSIONS	93

Mil-PRF-123 and GR900 high-reliability ceramic chips are also available. Refer to KEMET Catalog F-3054 for detailed information.

TANTALUM & CERAMIC CHIP PACKAGING

	PAGE
TANTALUM AND ALUMINUM CHIP PACKAGING INFORMATION.....	92, 94-95
CERAMIC CHIP PACKAGING INFORMATION	93-97
EMBOSSSED CARRIER TAPE REELING INFORMATION.....	95
PUNCHED CARRIER TAPE (PAPER TAPE) REELING INFORMATION	96
BULK CASSETTE PACKAGING	97
CERAMIC CHIP MARKING.....	97

Notice

Although the information in this catalog has been carefully checked for accuracy, and is believed to be correct and current, no warranty, either express or implied, is made as to either its applicability to, or its compatibility with, specific requirements; nor does KEMET Electronics Corporation assume any responsibility for correctness of this information, nor for damages consequent to its use. All design characteristics, specifications, tolerances, and the like are subject to change without notice.

The KEMET website (www.kemet.com) should be consulted for the very latest information on design characteristics, specifications, applications, and newly-released products, since previously-issued printed information may not be current.

Any capacitors misapplied may fail and thereby damage other circuit components. Please refer to application notes and recommendations in this catalog for a complete description of capacitor characteristics.

PRODUCT DESCRIPTION

KEMET's family of solid tantalum chip capacitors is designed and manufactured with the demanding requirements of surface mount technology in mind.

These devices extend the advantages of solid tantalum technology to today's surface mount circuit applications. Complementing multilayer ceramic chip convenience with capacitance ratings through 1500 μF , tantalum chip capacitors permit circuit designers to take full advantage of the benefits of surface mount technology.

T491 Series — Industrial

The leading choice in today's surface mount designs is the KEMET T491 Series. This product meets or exceeds the requirements of EIA standard 535BAAC. The physical outline and dimensions of this series conform to this global standard.

Five low profile case sizes are available in the T491 family. The R/2012-12, S/3216-12 and T/3528-12 case sizes have a maximum height of 1.2 mm. The U/6032-15 size has a maximum height of 1.5 mm, and the V/7343-20 has a maximum height of 2.0 mm.

This product was designed specifically for today's highly automated surface mount processes and equipment. This series uses the same proven solid tantalum KEMET technology acclaimed and respected throughout the world. Added to this is the latest in materials, processes and automation which result in a component unsurpassed worldwide in total performance and value.

The standard terminations are 100% matte tin and provide excellent wetting characteristics and compatibility with today's surface mount solder systems. Tin-Lead (SnPb) terminations are available upon request for any part number. Gold-plated terminations are also available for use with conductive epoxy attachment processes. The symmetrical terminations offer total compliancy to provide the thermal and mechanical stress relief required in today's technology. Lead frame attachments to the tantalum pellet are made via a microprocessor-controlled welding operation, and a high temperature silver epoxy adhesive system.

Standard packaging of these devices is tape and reel in accordance with EIA 481-1. This system provides perfect compatibility with all tape-fed placement units.

T492 Series — Military

KEMET is approved to MIL-PRF-55365/8 (CWR11), Weibull failure rate "B" level or 0.1% failures per 1,000 hours, "C" level or 0.01% failures per 1,000 hours, and "D" level or 0.001% failures per 1,000 hours. This CWR11 product — designated as KEMET's T492 Series — is a precision-molded device, with compliant leadframe terminations and indelible laser marking. This is the military version of the global IEC/EIA standard represented by KEMET's T491 Series. Tape and reeling per EIA 481-1 is standard.

T493 Series — Military - COTS

The T493 series is designed for the COTS (Commercial-Off-The-Shelf) requirements of military/aerospace applications. This series is a surface mount tantalum product offering various lead-frame surface finishes, Weibull grading and surge current testing options. The full part number includes a code defining the terminations, the Weibull reliability, surge test conditions, and the ESR range. The possible terminations include gold plated, hot solder dipped, solder plated, and solder fused. Reliability grading of B level (0.1%/kHours) and C level (0.01%/kHours) are available. Surge current testing options include: 10 cycles at 25°C, or 10-cycles at -55°C and +85°C. Both standard and low ESR options are available. All lots of this series are conditioned with MIL-PRF-55365 Group A testing.

T494 Series — Low ESR, Industrial Grade

The T494 is a low ESR series that is available in all the same case sizes and CV ratings as the popular T491 series. The T494 offers low ESR performance with the economy of an industrial grade device. This series is targeted for output filtering and other applications that may benefit from improved efficiency due to low ESR.

T495 Series — Low ESR, Surge Robust

The low ESR, surge robust T495 series is an important member of KEMET's tantalum chip family. Designed primarily for output filtering in switch-mode power supplies and DC-to-DC converters, the standard CV T495 values are also an excellent choice for battery-to-ground input filter applications.

This series builds upon proven technology used for industrial grade tantalum chip capacitors to offer several important advantages: very low ESR, high ripple current capability, excellent capacitance stability, plus improved ability to withstand high inrush currents. These benefits are achieved through a combination of proprietary design, material, and process parameters, as well as high-stress, low impedance electrical conditioning performed prior to screening. Capacitance values range from 4.7 μF to 1000 μF , in voltage ratings from 2.5 to 50 volts.

T496 Series — Fused

KEMET also offers a "fail-safe" fused solid tantalum chip capacitor. The built-in fuse element provides excellent protection from damaging short circuit conditions in applications where high fault currents exist. Protection from costly circuit damage due to reversed installation is offered with this device. Package sizes include the EIA standard 3528-12, 6032-15, 7343-31, and 7343-43 case size. Capacitance values range from 0.15 μF to 470.0 μF , in voltage ratings from 4 to 50. Standard capacitance tolerances include $\pm 20\%$ and $\pm 10\%$. Tape and reeling per EIA 481-1 is standard.

PRODUCT DESCRIPTION**T498 SERIES - High Temperature (150° C)**

The T498 Series is a high temperature version of KEMET's solid tantalum chip family that offers optimal performance in applications with operating temperatures of up to 150° C. Advancements in materials and testing have allowed for the introduction of this series which delivers a reliability level of 0.5% per 1000 hours at rated voltage at rated temperature. This series is available in five standard EIA case sizes with RoHS-Compliant/100% matte tin finish lead terminations as standard. Other termination options include 90Sn/10Pb finishes and gold for conductive adhesive attachment processes. Capacitance values range from .47µF to 220µF, in voltage ratings from 4 to 50 volts.

T510 Series — High Capacitance – Low ESR

The ultra-low ESR T510 Series is a breakthrough in solid tantalum capacitor technology. KEMET's T510 Series offers low ESR in the popular EIA 7343-43 and 7360-38 case sizes. The ultra-low ESR and high ripple current capability make the T510 an ideal choice for SMPS filtering and power decoupling of today's high speed microprocessors.

KEMET has developed an innovative construction platform that incorporates multiple capacitor elements, in parallel, inside a single package. This unique assembly, combined with KEMET's superior processing technology, provides the best combination of high CV, low ESR, and small size in a user friendly, molded, surface mount package.

T520 SERIES — Conductive Polymer

The Kemet Organic Capacitor (KO-CAP) is a Tantalum capacitor, with a Ta anode and Ta₂O₅ dielectric. However, a conductive, organic, polymer replaces the MnO₂ as the cathode plate of the capacitor. This results in very low ESR and improved cap retention at high frequency. The KO-CAP also exhibits a benign failure mode, which eliminates the ignition failures that can occur in standard MnO₂ Tantalum types. Note also that KO-CAPs may be operated at voltages up to 90% of rated voltage for

part types with rated voltage ≤ 10 volts and up to 80% of rated voltage for part types > 10 volts with equivalent or better reliability than standard tantalums operated at 50% of rated voltage.

The T520 series captures the best features of multilayer ceramic caps (low ESR and high frequency cap retention), aluminum electrolytics (benign failure mode), and proven solid tantalum technology (volumetric efficiency, surface mount capability, and no wearout mechanism). The KO-CAP can reduce component counts, eliminate through-hole assembly by replacing cumbersome leaded aluminum capacitors, and offer a more cost effective solution to high-cost high-cap ceramic capacitors. These benefits allow the designer to save both board space and money. See pages 42-52 for complete details.

T525 SERIES — High Temperature Conductive Polymer

The T525 Series is a version of KEMET's Tantalum Polymer Capacitor rated up to 125°C. This part type was introduced as Lead (Pb) Free and offers the same advantages as the T520 KO-CAP. This includes low ESR, high frequency capacitance retention and benign failure mode.

T530 SERIES — Conductive Polymer High Capacitance — Ultra Low ESR

KEMET is offering a multiple anode tantalum chip capacitor with a polymer material replacing the MnO₂ offering non-ignition, self-healing, 125°C performance capability with higher conductivity material that lowers the ESR. Packaged as multiple anodes to reduce the depth that the signal must penetrate, this parallel arrangement reduces the ESR further still to achieve the highest capacitance and lowest ESR of any other type of SMT capacitor with typical ESR values as low as 5 milliohms. With the reduced ESR, the enhanced capacitance retention in higher frequencies results in the lowest total capacitance solution and provides for the most economical solution in high power applications.

TANTALUM MnO₂ COMPONENT PERFORMANCE CHARACTERISTICS

Introduction

KEMET solid tantalum capacitors are identified by the initial “T,” followed by a unique “Series” number; for example, T491, T492, etc. Each Series denotes a general physical form and type of encapsulation, as well as limits on dimensions and certain electrical characteristics under standard conditions of 25°C, 50% relative humidity, and one atmosphere pressure. Specific requirements are set forth in the respective Product Series in this catalog. All series are 100% screened for leakage, capacitance, dissipation factor, and ESR. All Series are inspected to electrical limits using a minimum .1% AQL sampling plan, according to the Military Standard MIL-STD-105, even after 100% testing. This sampling plan, to the best of KEMET Electronics’ knowledge, meets or exceeds the generally accepted industry standard for similar products. KEMET capacitors may also be supplied, with prior agreement, to meet specifications with requirements differing from those of KEMET catalogs.

ELECTRICAL

1. General Application Class

Solid tantalum capacitors are usually applied in circuits where the AC component is small compared to the DC component. Typical uses known to KEMET Electronics include blocking, by-passing, decoupling, and filtering. They are also used in timing circuits. General purpose devices are recommended to have an external series resistance of 0.1Ω/volt to reduce the failure due to surge current. Newer devices designed for power applications (T495, T5XX), are built to eliminate this series resistance requirement. Because tantalum capacitors can experience scintillation (self-healing) in their life, the circuit impedance should not exceed 100KΩ or this will circumvent the scintillation and degrade leakage.

2. Operating Temperature Range

- -55°C to +125°C

Voltage derating is specified in Section 5. Performance characteristics over this temperature range are presented within the following sections.

3. Non-Operating Temperature Range

- -55°C to +125°C

Tantalum capacitors do not lose capacitance from the “de-forming” effect as do liquid-electrolytic capacitors. Storage at high temperature may cause a small, temporary increase in leakage current (measured under standard conditions), but the original value is usually restored within a few minutes after application of rated voltage.

Tantalum chips are not hermetically sealed, therefore they do exhibit reversible changes in parameters with respect to relative humidity (RH). Capacitance increases with increasing humidity. The limiting change, reached upon establishment

of equilibrium with the environment, is approximately -5% to +12% over the range from 25% to 95% RH, referred to the standard 50% RH. The amount of change is dependent upon size (capacitance and voltage rating, ie: CV product); small sizes might change no more than ±5%. Equilibrium at such extremes is seldom attained by plastic-cased capacitors, and the change in capacitance is consequently less. The rate of response to humidity changes increases with increasing temperature. Dissipation factor and ESR also increase with increasing RH.

DC leakage current may rise upon exposure to a combination of high temperature and high humidity, but is normally restored by voltage conditioning under standard conditions. The increase will be greater than that experienced under temperature influence alone because of conduction through absorbed water.

Tantalum chips may be affected by absorption of water on external insulating surfaces. The water film may also attract a layer of dust from the air, increasing the effect. The most sensitive parameter is leakage current.

4. Capacitance

- 0.1 μF to 1000 μF

Refer to part number tables for available capacitance ratings and tolerances by series.

Capacitance is measured at 120 Hz, up to 1.0 volt rms maximum and up to 2.5 volts DC maximum, at +25°C. DC bias causes only a small reduction in capacitance, up to about 2% when full rated voltage is applied. DC bias is not commonly used at room temperature, but is more commonly used at elevated temperatures. Capacitance decreases with increasing frequency.

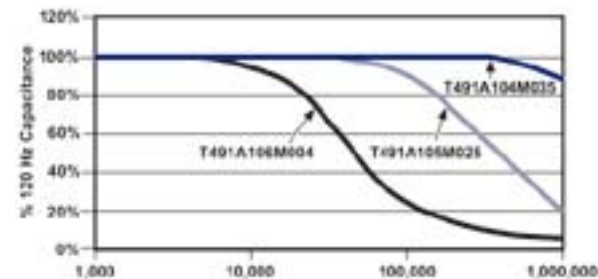

FIGURE 1 Typical Effect of Frequency upon Capacitance

Capacitance increases with increasing temperature.

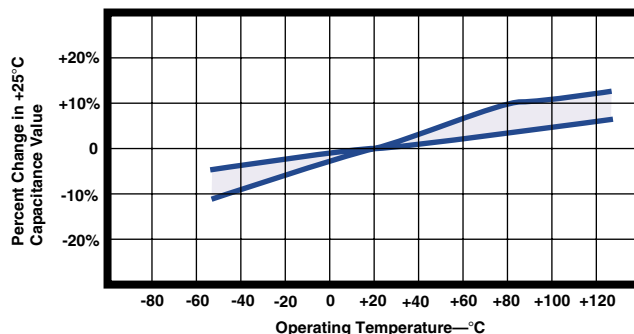

FIGURE 2 Typical Effect of Temperature upon Capacitance

TANTALUM MnO₂ COMPONENT PERFORMANCE CHARACTERISTICS (con't.)

TABLE 1 Maximum Capacitance Change with Temperature (ref: 25 °C)

Ambient Temperature		
-55°C	+85°C	+125°C
-10%	+10%	*+12% or +15%to20%

*+12% is standard. +15% and 20% apply to certain extended CV values as noted in part number tables.

5. Working DC Voltage (WVDC)

• **3 to 50 volts**

Refer to part number tables for available voltage ratings by series.

These voltages are the maximum recommended peak DC operating voltages from -55°C to +85°C for continuous duty. These voltages are derated linearly above +85°C to 2/3 rated voltage for operation at +125°C (See Figure 3). For added reliability it is recommended to operate at a 50% derating of the working voltage for tantalum capacitors with MnO₂ as a cathode. See page 39 for working DC Voltage of high temperature T498 product.

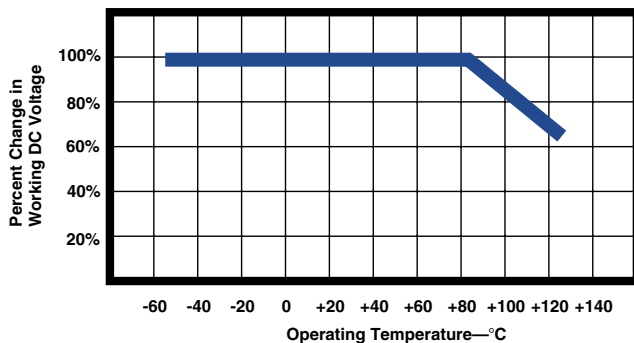

FIGURE 3 Working DC Voltage Change with Temperature

6. Surge Voltage

TABLE 2 Surge Voltage Ratings at +25°C, +85°C & +125°C

Rated Working Volts @ +25°C & +85°C	Surge Voltage @ +25°C & +85°C	Derated DC Volts @ +125°C	Surge Voltage @ +125°C
3	4	2	2.4
4	5.2	2.7	3.2
6	8	4	5
10	13	7	8
16	20	10	12
20	26	13	16
25	33	17	20
35	46	23	28
50	65	33	40

Surge voltage tests are performed at +25°C, +85°C and +125°C with the applicable surge voltage. The surge voltage is applied for 1000 cycles of 30 seconds at voltage through a 33 ohm series resistor and 30 seconds off voltage with the capacitor discharged through a 33 ohm resistor. Upon completing the test, the capacitors are allowed to stabilize at room temperature. Capacitance, DCL and DF are then tested:

- Capacitance — within ± 5% of initial value
- DC Leakage — within initial limit
- Dissipation Factor — within initial limit
- ESR — within initial limit

7. Reverse Voltage and Polarity

TABLE 3 Reverse Voltage Ratings

Temperature	Permissible Reverse Voltage
+25°C	15% of Rated Voltage
+85°C	5% of Rated Voltage
+125°C	1% of Rated Voltage

Solid tantalum capacitors are polarized devices and may be permanently damaged or destroyed if connected with the wrong polarity. The positive terminal is identified on the capacitor body by a stripe and a beveled edge. A small degree of transient reverse voltage is permissible for short periods per Table 3. The capacitors should not be operated continuously in reverse mode, even within these limits.

8. DC Leakage Current (DCL)

Refer to part number tables for maximum leakage current limits.

DC leakage current is the current that, after a one-to five-minute charging period, flows through a capacitor when voltage is applied. Leakage is measured at +25°C with full rated DC voltage applied to the capacitor through a 1000 ohm resistor in series with the capacitor.

DC leakage current increases with increasing temperature.

TABLE 4 Leakage Limit Multipliers at Specified Temperatures (ref: 25 °C limits)

Ambient Temperature		
-55°C	+85°C	+125°C
N/A	10X	12X

TANTALUM MnO₂ COMPONENT PERFORMANCE CHARACTERISTICS (con't.)

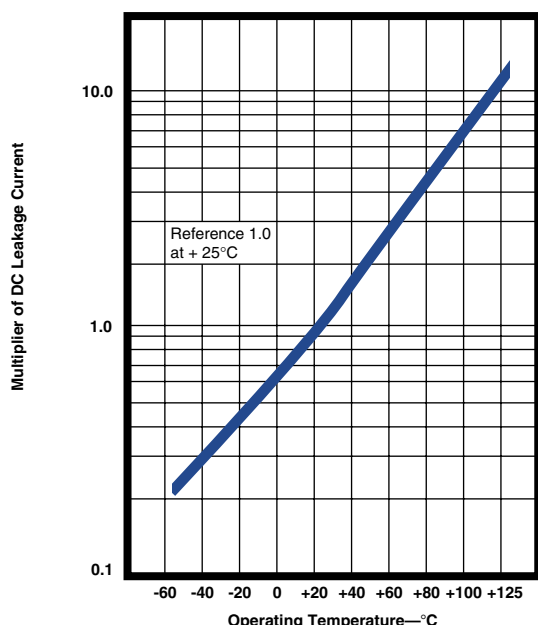

FIGURE 4 Typical Effect of Temperature upon DC Leakage Current

DC leakage current decreases with decreasing applied voltage.

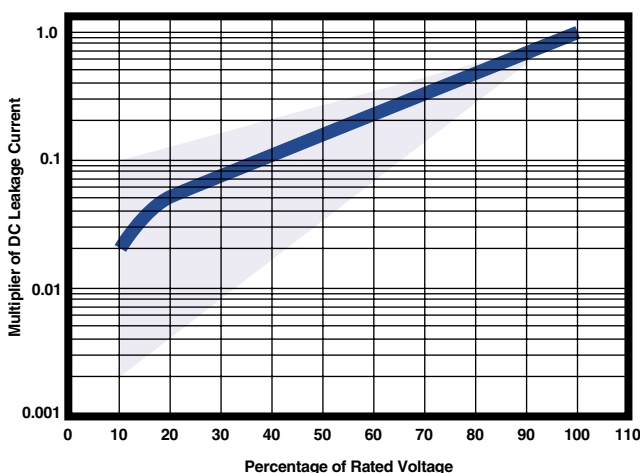

FIGURE 5 Typical Effect of Applied Voltage on DC Leakage Current.

9. Dissipation Factor (DF)

Refer to part number tables for maximum DF limits.

Dissipation factor is measured at 120 Hz, up to 1.0 volt rms maximum, and up to 2.0 volts DC maximum at +25°C. The application of DC bias causes a small reduction in DF, about 0.2% when full rated voltage is applied. DF increases with increasing frequency.

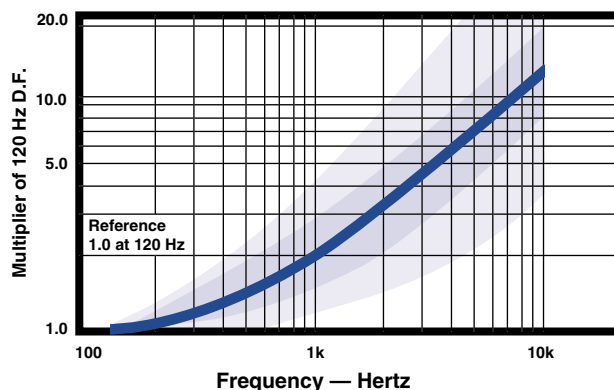

FIGURE 6 Typical Effect of Frequency upon Dissipation Factor

Dissipation factor is a very useful low frequency (120 Hz) measurement of the resistive component of a capacitor. It is the ratio of the equivalent series resistance (ESR) to the capacitive reactance, (X_c) and is usually expressed as a percentage. It is directly proportional to both capacitance and frequency. Dissipation factor loses its importance at higher frequencies, (above about 1 kHz), where impedance (Z) and equivalent series resistance (ESR) are the normal parameters of concern.

$$DF = \frac{R}{X_c} = 2\pi fCR$$

DF = Dissipation Factor
 R = Equivalent Series Resistance (Ohms)
 X_c = Capacitive Reactance (Ohms)
 f = Frequency (Hertz)
 C = Series Capacitance (Farads)

DF is also referred to as $\tan \delta$ or "loss tangent." The "Quality Factor," "Q," is the reciprocal of DF.

DF decreases with temperature above +25°C and may also increase at lower temperatures. Unfortunately, one general limit for DF cannot be specified for all capacitance/voltage combinations, nor can response to temperature be simply stated. DC bias is not commonly used at room temperature, but is more commonly used at elevated temperatures.

10. Equivalent Series Resistance (ESR) and Impedance (Z)

Equivalent Series Resistance (ESR) is the preferred high-frequency statement of the resistance unavoidably appearing in these capacitors. ESR is not a pure resistance, and it decreases with increasing frequency.

Total impedance of the capacitor is the vector sum of capacitive reactance (X_c) and ESR, below resonance; above resonance total impedance is the vector sum of inductive reactance (X_L) and ESR.

TANTALUM MnO₂ COMPONENT PERFORMANCE CHARACTERISTICS (con't.)

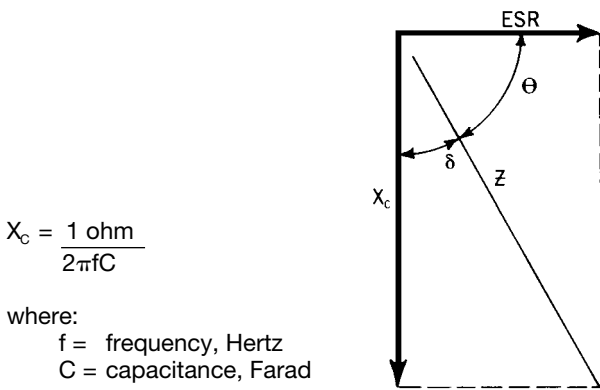

FIGURE 7a Total Impedance of the Capacitor Below Resonance

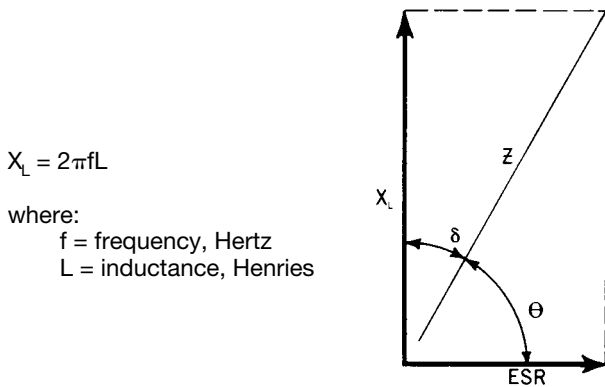

FIGURE 7b Total Impedance of the Capacitor Above Resonance

To understand the many elements of a capacitor, see Figure 8.

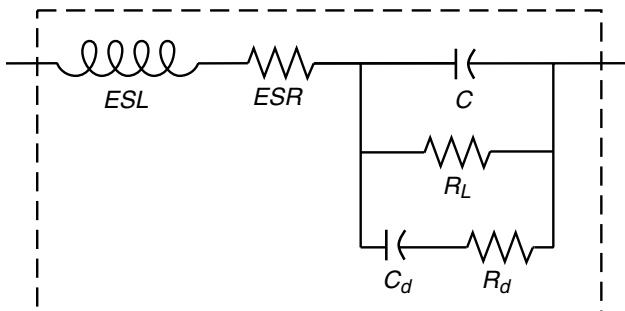

FIGURE 8 The Real Capacitor

A capacitor is a complex impedance consisting of many series and parallel elements, each adding to the complexity of the measurement system.

ESL — Represents lead wire and construction inductance. In most instances (especially in solid tantalum and monolithic ceramic capacitors) it is insignificant at the basic measurement frequencies of 120 and 1000 Hz.

ESR — Represents the actual ohmic series resistance in series with the capacitance. Lead wires and capacitor electrodes are contributing sources.

RL — Capacitor Leakage Resistance. Typically it can reach 50,000 megohms in a tantalum capacitor. It can exceed 10¹² ohms in monolithic ceramics and in film capacitors.

Rd — The dielectric loss contributed by dielectric absorption and molecular polarization. It becomes very significant in high frequency measurements and applications. Its value varies with frequency.

Cd — The inherent dielectric absorption of the solid tantalum capacitor which typically equates to 1-2% of the applied voltage.

As frequency increases, Xc continues to decrease according to its equation above. There is unavoidable inductance as well as resistance in all capacitors, and at some point in frequency, the reactance ceases to be capacitive and becomes inductive. This frequency is called the self-resonant point. In solid tantalum capacitors, the resonance is damped by the ESR, and a smooth, rather than abrupt, transition from capacitive to inductive reactance follows.

Typical ESR/Z frequency response curves are shown in Figures 9a and 9b. These curves are for selected ratings and represent typical T491 Series performance. Maximum limits for 100 kHz ESR are listed in the part number tables for each series. Note that the T494 Series offers low ESR and the T495 Series is specially designed for very low ESR performance. Refer to page 31 for more information. See also KEMET's T510 Series low ESR ratings on page 40.

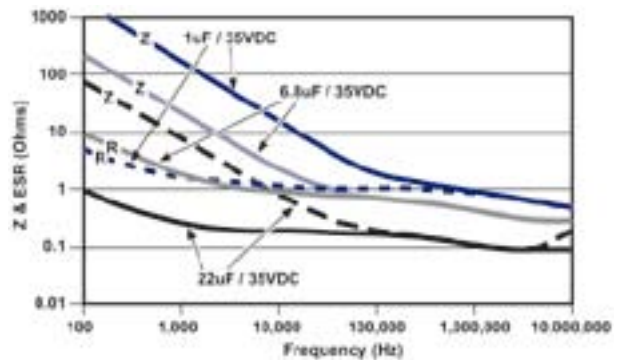

FIGURE 9a ESR & Impedance (Z) vs Frequency

TANTALUM MnO₂ COMPONENT PERFORMANCE CHARACTERISTICS (con't.)

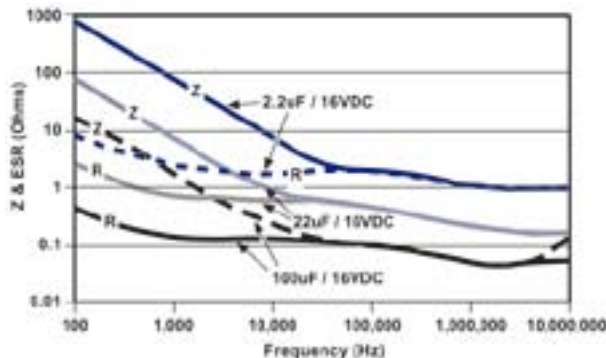

FIGURE 9b ESR & Impedance (z) vs Frequency

ESR and Z are also affected by temperature. At 100 kHz, ESR decreases with increasing temperature. The amount of change is influenced by the size of the capacitor and is generally more pronounced on smaller ratings.

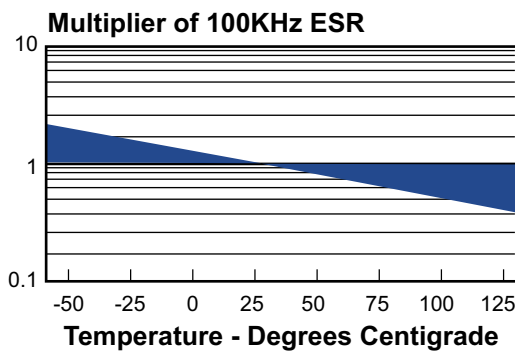

FIGURE 10 Typical Effect of Temperature on 100 kHz ESR

11. AC Power Dissipation

Power dissipation is a function of capacitor size and materials. Maximum power ratings have been established for all case sizes to prevent overheating. In actual use, the capacitor's ability to dissipate the heat generated at any given power level may be affected by a variety of circuit factors. These include board density, pad size, heat sinks and air circulation.

TABLE 5 Tantalum Chip Power Dissipation Ratings

Case Code		Maximum Power Dissipation mW @ +25°C w/+20°C Rise
KEMET	EIA	
R	2012-12	25
S	3216-12	60
T	3528-12	70
U	6032-15	90
V	7343-20	125
A	3216-18	75
B	3528-21	85
C	3062-28	110
D	7343-31	150
X	7343-43	165
E	7260-38	200
T530D	7343-31	255
T510X, T530X	7343-43	270
T510E, T530E	7260-38	285

12. AC Operation

Permissible AC ripple voltage and current are related to equivalent series resistance (ESR) and power dissipation capability.

Permissible AC ripple voltage which may be applied is limited by three criteria:

- The positive peak AC voltage plus the DC bias voltage, if any, must not exceed the DC voltage rating of the capacitor.
- The negative peak AC voltage, in combination with the bias voltage, if any, must not exceed the permissible reverse voltage ratings presented in Table 3.
- The power dissipated in the ESR of the capacitor must not exceed the appropriate value specified in Table 5.

Actual power dissipated may be calculated from the following:

$$P = I^2 R$$

$$\text{Substituting } I = \frac{E}{Z}, \quad P = \frac{E^2 R}{Z^2}$$

where:

I = rms ripple current (amperes)

E = rms ripple voltage (volts)

P = power (watts)

Z = impedance at specified frequency (ohms)

R = equivalent series resistance at specified frequency (ohms)

Using P max from Table 5, maximum allowable rms ripple current or voltage may be determined as follows:

$$I(\text{max}) = \sqrt{P \text{ max} / R} \quad E(\text{max}) = Z \sqrt{P \text{ max} / R}$$

These values should be derated at elevated temperatures as follows:

Temperature	Derating Factor
85°C	.9
125°C	.4

ENVIRONMENTAL

13. Temperature Stability

TABLE 6 Temperature Stability Limits

Step No.	Temp.	Δ Capacitance	Leakage Current	Dissipation Factor
1	+25°C	within specified tolerance	within original limit	within original limit
2	-55°C	within ± 10% of initial value	N/A	within original limit**
3	+25°C	within ± 5% of initial value	within original limit	within original limit**
4	+ 85°C	within ± 10% of initial value	within 10X original limit	within original limit***
5	+125°C	*within ± 12% or 20% of initial value	within 12X original limit	within original limit***
6	+25°C	within ± 5% of initial value	within original limit	within original limit

+12% is standard. +15% or +20% applies to certain CV values

Contact KEMET representative for details.

**within 1.5x initial limit for extended CV values.

***within 1.15x initial limit for extended CV values.

TANTALUM MnO₂ COMPONENT PERFORMANCE CHARACTERISTICS (con't.)

Mounted capacitors withstand extreme temperature testing at a succession of continuous steps at +25°C, -55°C, +25°C, +85°C, +125°C, +25°C, in the order stated. Capacitors shall be brought to thermal stability at each test temperature. Capacitance, DF and DCL are measured at each test temperature except that DCL is not measured at -55°C. DC bias of 2.0± 0.5 is recommended for the capacitance and D F requirements.

14. Thermal Shock**• Mil-Std-202, Method 107, Condition B**

Minimum temperature -55°C, mounted

Post Test Performance:

- Capacitance — within ±5% of initial value
- DC Leakage — within initial limit
- Dissipation Factor — within initial limit
- ESR — within initial limit

15. Moisture Resistance**• Mil-Std-202, Method 106**

Steps 7a and 7b excluded, rated voltage, 42 cycles, mounted

Post Test Performance:

- Capacitance — within ±10% of initial value
- DC Leakage — within initial limit
- Dissipation Factor — within initial limit
- ESR — within initial limit

• JEDEC J-STD-20C — meets MSL1 for Pb-free assembly**16. Electrostatic Discharge (ESD)****• Human Body Model**

2,000 ±50 volts, 1,500 ±5% ohms, 40 nanosecond pulse each polarity, 1 pulse each polarity, 5 seconds between pulses, +25°C.

• Charged Device Model

200 ± 5 volts, 0 ohms, 40 nanosecond pulse, each polarity, 9 pulses each polarity, 5 seconds between pulses, +25°C.

Product subjected to above test condition demonstrate *no sensitivity* to electrostatic discharge.

17. Long Term Stability

Within the general class of electrolytic capacitors, solid tantalum capacitors offer unusual stability of the three important parameters: capacitance, dissipation factor and leakage current. These solid-state devices are not subject to the effects of electrolysis, deforming or drying-out associated with liquid-electrolyte capacitors.

When stabilized for measurement at standard conditions, capacitance will typically change less than ±3% during a 10,000 hour life test +85°C.

The same comparative change has been observed in shelf tests at +25°C extending for 50,000 hours. (Some of this change may stem from instrument or fixture error.)

Dissipation factor exhibits no typical trend. Data from 10,000 hour life test at +85°C show that initial limits (at standard conditions) are not exceeded at the conclusion of these tests.

Leakage current is more variable than capacitance or DF; in fact, leakage current typically exhibits a logarithmic dependence in several respects. Military Specifications permit leakage current (measured at standard conditions) to rise by a factor of four over 10,000 hour life tests. Typical behavior shows a lower rate of change, which may be negative or positive. Initial leakage currents are frequently so low (less than 0.1 nanoampere in the smallest CV capacitors) that changes of several orders of magnitude have no discernable effect on the usual circuit designs.

18. Failure Mode

Capacitor failure may be induced by exceeding 50% of rated voltage of the capacitor with forward DC voltage, reverse DC voltage, power dissipation, or temperature. As with any practical device, these capacitors also possess an inherent, although low, failure rate when operated at less than 50% of the rated voltage of the capacitor.

The dominant failure mode is by short-circuit. Minor parametric drifts are of no consequence in circuits suitable for solid tantalum capacitors. Catastrophic failure occurs as an avalanche in DC leakage current over a short (millisecond) time span. The failed capacitor, while called "short-circuited", may exhibit a DC resistance of 10 to 10⁴ ohm.

If a failed capacitor is in an unprotected low-impedance circuit, continued flow of current through the capacitor may obviously produce severe overheating. The over-heated capacitor may damage the circuit board or nearby components. Protection against such occurrence is obtained by current-limiting devices or fuses provided by the circuit design. KEMET's T496 series offers a built-in fuse to convert the normal short circuit failure mode to an open circuit.

Fortunately, the inherent failure rate of KEMET solid tantalum capacitors is low, and this failure rate may be further improved by circuit design. Statistical failure rates are provided for military capacitors. Relating circuit conditions to failure rate is aided by the guides in the section following.

TANTALUM MnO₂ COMPONENT PERFORMANCE CHARACTERISTICS (con't.)

RELIABILITY

19. Reliability Prediction

Solid tantalum capacitors exhibit no degradation failure mode during shelf storage and show a constantly decreasing failure rate (i.e., absence of any wear out mechanism) during life tests. This failure rate is dependent upon three important application conditions; DC Voltage, ambient temperature, and circuit impedance. Additional effects are attributable to the capacitance of the device and atmospheric and mechanical exposure of the assembled circuit. The 1000 multiplier at the end converts the failure rate to parts-per-billion piece-hours. A prediction of the failure rate can be made using these application conditions and the formulas and tables listed in MIL-HDBK-217F (Notice 2).

Base Multiplier: The first multiplier is the base multiplier (2) established for the capacitor type. For “CWR-Chips” or surface mount components the base multiplier is 0.00005, and for “CSR-Leaded” devices, the base multiplier is 0.00040.

Temperature: The temperature factor is given as (3). From this formula, it can be seen that the unity factor, or 1, is derived at an ambient temperature of +25°C (+298°K), and that at temperatures below this the multiplier is decreasing and at temperatures above this the multiplier is increasing.

Voltage: The multiplier for application voltage (4) is a two step process: first, the application voltage is compared to 60% of rated voltage, and then this ratio is raised to an exponential power of 17 and added to unity. Consider applications of 50%, 60%, 70%, 80% and 90% of rated voltage. The multipliers for these applications would be 1.045, 2.00, 14.7, 134, and 986, respectively. From these results it is evident why manufacturers recommend application voltages not to exceed 50% rated voltages.

Capacitance: There is a factor (5) applied to the capacitance (in µF) which effectively increases the failure rate for increasing capacitance (increases in effective area resulting in increases in possible faults).

Series Resistance: The series resistance is only concerned with the resistance per application bias (ohms per volt) external to the capacitor, and does not include the ESR as a factor.

Environmental: The environmental factor is determined by the harshness of the ambient conditions beyond temperature. An explanation of these ratings is included in the MIL specification and are too extensive to be covered here. In most cases, this factor is set to ground benign or G_B, with the resulting factor equal to “1”.

(1)	$\lambda_V = \lambda_b \pi_T \pi_C \pi_V \pi_{SR} \pi_Q \pi_E \times 1000$
(2)	$\lambda_b = 0.00005_{CWR} \text{ OR } 0.0004_{CSR}$
(3)	$\pi_T = \exp \left[\frac{-0.15}{8.617 \cdot 10^{-5}} \left(\frac{1}{T_{Amb}} - \frac{1}{298} \right) \right]$
(4)	$S = \frac{\text{Application-Voltage}}{\text{Rated-Voltage}} \quad \pi_V = \left(\frac{S}{0.6} \right)^{17} + 1$
(5)	$\pi_C = 1.0 \cdot C^{.023}$
(6)	$\pi_{SR} = \text{Lookup Table} \quad \pi_E = \text{Lookup Table}$
(7)	$\pi_Q = \sqrt{\left(\frac{\text{Pcs. Fail}}{\text{Pcs. Tested} \times \text{Hrs. Tested}} \times 100,000 \right)}$

FIGURE 11a. MIL-HDBK-217F Notice 2 formulas.

CR (ΩV)	π _{SR}
>0.8	0.66
0.6-0.8	1.0
0.4-0.6	1.3
0.2-0.4	2.0
0.1-0.2	2.7
<0.1	3.3

FIGURE 11b. Table for circuit resistance multipliers.

Quality Factor: All of these multipliers are applied to the established or base failure rate of the part. The T492 Series is qualified under U.S. military specification MIL-PRF-55365. Failure rates as low as 0.001% kHr are available under this test program.

For series not covered by military specifications, an internal sampling program is operated by KEMET Quality Assurance whereby parts are put on life test at rated voltage for 2000 hours. The confidence level chosen for the reporting data is 60%. (The cost of sampling each batch would be prohibitive, and no claim is made to guarantee the failure rate of each batch.) With this testing and each new qualification test for new parts, the average failure rate for all commercial Series lies between 0.1% and 1.0% per thousand-piece-hours.

FIT Calculator

All of these factors are gathered into a Windows based software, available free from the KEMET web site (www.kemet.com). The “FIT Calculator” software does all the calculations and look-ups based on information entered or selected by the operator. A manual may also be downloaded from the same web page to explain the controls and displays. The manual as well as a help screen also detail the environmental conditions.

TANTALUM MnO₂ COMPONENT PERFORMANCE CHARACTERISTICS (con't.)

20. Surge Current

All conventional reliability testing is conducted under steady-state DC voltage. Experience indicates that AC ripple, within the limits prescribed, has little effect on failure rate. Heavy surge currents are possible in some applications, however. Circuit impedance may be very low (below the recommended 0.1 ohm/volt) or there may be driving inductance to cause voltage “ringing.” Surge current may appear during turn-on of equipment, for example. Failure rate under current-surge conditions may not be predictable from conventional life test data.

Capacitors are capable of withstanding a 4 ±1 second charge of rated voltage (±2%) through a total circuit resistance (excluding the capacitor) of 1 ±0.2 ohms at +25°C, followed by a 4 ±1 second discharge to a voltage below 1% of the rated voltage. This cycle is repeated consecutively three (3) times. Post test performance:

- a. Capacitance — within ±5% of initial value
- b. DC Leakage — within initial limit
- c. Dissipation Factor — within initial limit

100% production surge current testing is performed on all Tantalum Chip series for case sizes C, D, E, X, U, V. The total test circuit resistance is ≤ 0.5 ohms. The applied voltage is 75% of rated voltage for all series except the T495 and T510 which are surged at 100% of rated voltage. Four surge cycles are applied. Parts not capable of surviving this test are removed at subsequent electrical screening. See T493 Series on page 22 for specific surge options.

21. Storage Life Test

- **2,000 hours, +125°C, Unbiased, Mounted**

Post Test Performance:

- a. Capacitance — within ±10% of initial value
- b. DC Leakage — within initial limit
- c. Dissipation Factor — within initial limit
- d. ESR — within initial limit
- e. Physical — no degradation of function

22. Standard Life Test

- **2,000 hours, +85°C, Rated Voltage, Mounted**

Post Test Performance:

- a. Capacitance — within ±10% of initial value
- b. DC Leakage — within 125% of initial limit
- c. Dissipation Factor — within initial limit
- d. ESR — within initial limit
- e. Physical — no degradation of function

23. High Temperature Life Test

- **2,000 hours, +125°C, 2/3 Rated Voltage, Mounted**

Post Test Performance:

- a. Capacitance — within ±10% of initial value
- b. DC Leakage — within 125% of initial limit
- c. Dissipation Factor — within initial limit
- d. ESR — within initial limit
- e. Physical — no degradation of function

MECHANICAL

24. Resistance to Solvents

- **Mil-Std-202, Method 215**

Post Test Performance:

- a. Capacitance — within ±10% of initial value
- b. DC Leakage — within initial limit
- c. Dissipation Factor — within initial limit
- d. Physical — no degradation of case, terminals or marking.

25. Fungus

- **Mil-Std-810, Method 508**

26. Flammability

- **UL94 VO Classification**

Encapsulant materials meet this classification.

27. Resistance to Soldering Heat

- **Wave Solder**
+260 ±5°C, 10 Seconds
- **Infrared Reflow**
+230 ±5°C, 30 Seconds
- **Vapor Phase Reflow**
+215 ±5°C, 2 minutes

Post Test Performance:

- a. Capacitance — within ±10% of Initial Value
- b. DC Leakage — within Initial Limit
- c. Dissipation Factor — within Initial Limit

28. Solderability

- **Mil-Std-202, Method 208**
- **ANSI/J-STD-002, Test B**

Applies to Solder and Tin Coated terminations only. Does not apply to optional gold-plated terminations.

29. Vibration

- **Mil-Std-202, Method 204, Condition D,**
10 Hz to 2,000 Hz, 20G Peak

Post Test Performance:

- a. Capacitance — within ± 10% of initial value
- b. DC Leakage — within initial limit
- c. Dissipation Factor — within initial limit

30. Shock

- **Mil-Std-202, Method 213, Condition I,**
100 G Peak

Post Test Performance:

- a. Capacitance — within ±10% of initial value
- b. DC Leakage — within initial limit
- c. Dissipation Factor — within initial limit

31. Terminal Strength

- **Pull Force**
• **One Pound (454 grams), 30 Seconds**

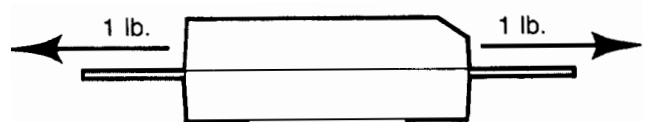

TANTALUM MnO₂ COMPONENT PERFORMANCE CHARACTERISTICS (con't.)

- **Tensile Force**
- **Four Pounds (1.8 kilograms), 60 Seconds**

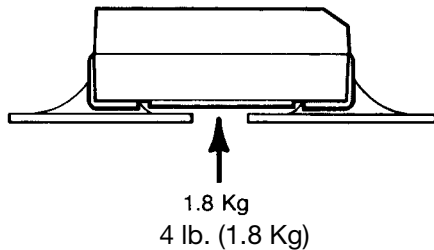

- **Shear Force**
- Table 8 Maximum Shear Loads**

Case Code		Maximum Shear Loads	
KEMET	EIA	Kilograms	Pounds
R	2012-12	2.4	5.3
S	3216-12	3.2	7.0
T	3528-12	3.6	8.0
U	6032-15	4.5	10.0
V	7343-20	5.0	11.0
A	3216-18	3.2	7.0
B	3528-21	3.6	8.0
C	6032-28	4.5	10.0
D	7343-31	5.0	11.0
X	7343-43	5.0	11.0
E	7260-38	5.0	11.0

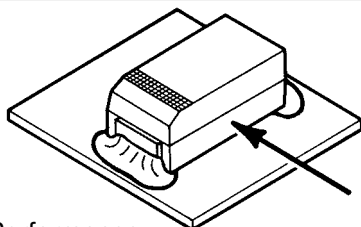

Post Test Performance:

- Capacitance — within $\pm 5\%$ of initial value
- DC Leakage — within initial limit
- Dissipation Factor — within initial limit

APPLICATIONS

32. Handling

Automatic handling of encapsulated components is enhanced by the molded case which provides compatibility with all types of high speed pick and place equipment. Manual handling of these devices presents no unique problems. Care should be taken with your fingers, however, to avoid touching the solder-coated terminations as body oils, acids and salts will degrade the solderability of these terminations. Finger cots should be used whenever manually handling all solderable surfaces.

33. Termination Coating

KEMET's standard termination finish is 100% Sn (Excluding the T492/3 series. Refer to specific lead frame options available on T493 Series). Standard terminations can be ordered with a "T" suffix in the lead material designator of the KEMET part number. Components ordered with the "T" suffix are Pb-Free/RoHS compliant and are backward and forward compatible with SnPb

and Pb-Free soldering processes.

90Sn/10Pb terminations are also available and can be ordered with an "H" suffix.

KEMET's "S" suffix remains an active termination designator for current designs but is not recommended for new designs. Parts ordered with an "S" suffix are not guaranteed to be Pb-Free or RoHS compliant. Refer to www.kemet.com for information on Pb-Free transition.

For conductive adhesive attachment processes, a gold termination finish is available for most series and case sizes. Refer to the specific series for details.

34. Recommended Mounting Pad Geometries

Proper mounting pad geometries are essential for successful solder connections. These dimensions are highly process sensitive and should be designed to maximize the integrity of the solder joint, and to minimize component rework due to unacceptable solder joints.

Figure 12 illustrates pad geometry. Tables 9 & 10 provide recommended pad dimensions for both wave and reflow soldering techniques. These dimensions are intended to be a starting point for circuit board designers, to be fine tuned, if necessary, based upon the peculiarities of the soldering process and/or circuit board design.

Contact KEMET for Engineering Bulletin Number F-2100 entitled "Surface Mount Mounting Pad Dimensions and Considerations" for further details on this subject.

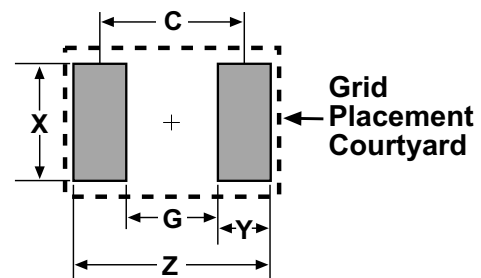

Figure 12

Table 9 – Land Pattern Dimensions for Reflow Solder

KEMET/EIA Size Code	Pad Dimensions - mm				
	Z	G	X	Y (ref)	C (ref)
R/2012-12	3.90	0.80	1.80	1.55	2.35
A/3216-18, S/3216-12	4.70	0.80	1.50	1.95	2.75
B/3528-21, T/3528-12	5.00	1.10	2.50	1.95	3.05
C/6032-28, U/6032-15	7.60	2.50	2.50	2.55	5.05
D/7343-31, V/7343-20, X/7343-43	8.90	3.80	2.70	2.55	6.35
E/7260-38	8.90	3.80	4.40	2.55	6.35

Table 10 – Land Pattern Dimensions for Wave Solder

KEMET/EIA Size Code	Pad Dimensions - mm				
	Z	G	X	Y (ref)	C (ref)
R/2012-12	4.30	0.80	1.26	1.75	2.55
A/3216-18, S/3216-12	5.10	0.80	1.10	2.15	2.95
B/3528-21, T/3528-12	5.40	1.10	1.80	2.15	3.25
C/6032-28, U/6032-15	8.00	2.50	1.80	2.75	5.25
D/7343-31, V/7343-20, X/7343-43	9.70	3.80	2.70	2.95	6.75
E/7260-38	9.70	3.80	4.40	2.95	6.75

TANTALUM MnO₂ COMPONENT PERFORMANCE CHARACTERISTICS (con't.)

35. Soldering

KEMET's families of surface mount tantalum capacitors are compatible with wave (single or dual) soldering and IR or vapor phase reflow techniques. Solder-coated terminations have excellent wetting characteristics for high integrity solder fillets. Preheating of these components is recommended to avoid extreme thermal stress. Figure 13 represents recommended maximum solder temperature / time combinations for these devices.

Note that although the X/7343-43 case size can withstand wave soldering, the tall profile (4.3mm maximum) dictates care in wave process development.

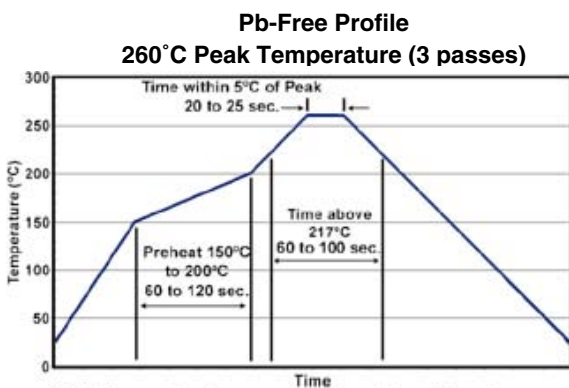
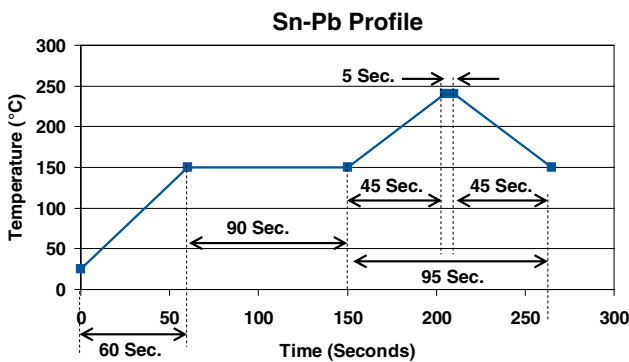

NOTE: Temperature is measured on the surface of the part

FIGURE 13 Time/Temperature Soldering Profile

Hand-soldering should be performed with care due to the difficulty in process control. If performed, care should be taken to avoid contact of the soldering iron to the molded case. The iron should be used to heat the solder pad, applying solder between the pad and the termination, until reflow occurs. The iron should be removed. "Wiping" the edges of a chip and heating the top surface is not recommended.

During typical reflow operations a slight darkening of the gold-colored epoxy may be observed. This slight darkening is normal and is not harmful to the product. Marking permanency is not affected by this change.

36. Washing

Standard washing techniques and solvents are compatible with all KEMET surface mount tantalum capacitors. Solvents such as Freon TMC and TMS, Trichlorethane, methylene chloride, prelete, and isopropyl alcohol are not harmful to these components.

If ultrasonic agitation is utilized in the cleaning process, care should be taken to minimize energy levels and exposure times to avoid damage to the terminations.

KEMET tantalum chips are also compatible with newer aqueous and semi-aqueous processes. Please follow the recommendations for cleaning as defined by the solder vendor.

37. Encapsulations

Under normal circumstances, potting or encapsulation of KEMET tantalum chips is not required.

38. Storage Environment

Tantalum chip capacitors should be stored in normal working environments. While the chips themselves are quite robust in other environments, solderability will be degraded by exposure to high temperatures, high humidity, corrosive atmospheres, and long term storage. In addition, packaging materials will be degraded by high temperature – reels may soften or warp, and tape peel force may increase. KEMET recommends that maximum storage temperature not exceed 40 degrees C, and maximum storage humidity not exceed 60% relative humidity. In addition, temperature fluctuations should be minimized to avoid condensation on the parts, and atmospheres should be free of chlorine and sulfur bearing compounds. For optimized solderability, chip stock should be used promptly, preferably within 3 years of receipt.

39. Component Weights

• **T49x, T510 Series**

Series	Case Size	Typical Weight (mg)
T49x	A/3216-18	32
T49x	B/3528-21	60
T49x	C/6032-28	130
T49x	D/7343-31	320
T49x	X/7343-43	500
T49x	E/7360-38	600
T49x	R/2012-12	10
T49x	S/3216-12	21
T49x	T/3528-12	34
T49x	U/6032-15	70
T49x	V/7343-20	206
T510	D/7343-31	338
T510	X/7343-43	510
T510	E/7360-38	645

SOLID TANTALUM CHIP CAPACITORS

T491 SERIES - Precision Molded Chip



FEATURES

- Meets or Exceeds EIA Standard 535BAAC
- Taped and Reeled per EIA 481-1
- Symmetrical, Compliant Terminations
- Optional Gold-plated Terminations
- Laser-marked Case
- 100% Surge current test on C, D, E, U, V, X sizes
- Halogen Free Epoxy
- Capacitance: 0.1 μ F to 1000 μ F
- Tolerance: $\pm 10\%$, $\pm 20\%$
- Voltage: 2.5-50 VDC
- Extended Range Values
- Low Profile Case Sizes
- RoHS Compliance & Lead Free Terminations (See www.kemet.com for transition information)
- Operating Temperature: -55°C to $+125^{\circ}\text{C}$

CAPACITOR OUTLINE DRAWING

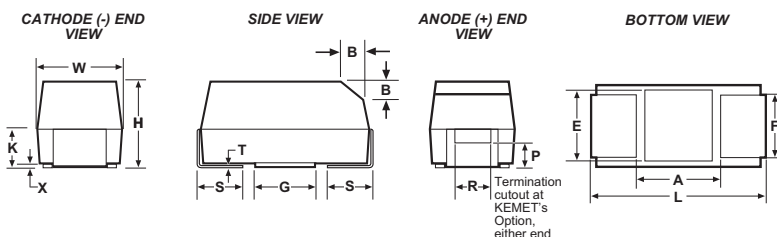

STANDARD T491 DIMENSIONS

Millimeters (inches)

CASE SIZE	KEMET	EIA	COMPONENT													
			L*	W*	H*	K* ± 0.20 $\pm (.008)$	F* ± 0.1 $\pm (.004)$	S* ± 0.3 $\pm (.012)$	B ± 0.15 $(\text{Ref}) \pm (.006)$	X (Ref)	P (Ref)	R (Ref)	T (Ref)	A (Min)	G (Ref)	E (Ref)
A	3216-18		3.2 ± 0.2 (.126 $\pm .008$)	1.6 ± 0.2 (.063 $\pm .008$)	1.6 ± 0.2 (.063 $\pm .008$)	0.9 (.035)	1.2 (.047)	0.8 (.031)	0.4 (.016)	0.10 ± 0.10 (.004 $\pm .004$)	0.4 (.016)	0.4 (.016)	0.13 (.005)	1.4 (.055)	1.1 (.043)	1.3 (.051)
B	3528-21		3.5 ± 0.2 (.138 $\pm .008$)	2.8 ± 0.2 (.110 $\pm .008$)	1.9 ± 0.2 (.075 $\pm .008$)	1.1 (.043)	2.2 (.087)	0.8 (.031)	0.4 (.016)	0.10 ± 0.10 (.004 $\pm .004$)	0.5 (.020)	1.0 (.039)	0.13 (.005)	2.1 (.083)	1.8 (.071)	2.2 (.087)
C	6032-28		6.0 ± 0.3 (.236 $\pm .012$)	3.2 ± 0.3 (.126 $\pm .012$)	2.5 ± 0.3 (.098 $\pm .012$)	1.4 (.055)	2.2 (.087)	1.3 (.051)	0.5 (.020)	0.10 ± 0.10 (.004 $\pm .004$)	0.9 (.035)	1.0 (.039)	0.13 (.005)	3.1 (.122)	2.8 (.110)	2.4 (.094)
D	7343-31		7.3 ± 0.3 (.287 $\pm .012$)	4.3 ± 0.3 (.169 $\pm .012$)	2.8 ± 0.3 (.110 $\pm .012$)	1.5 (.059)	2.4 (.094)	1.3 (.051)	0.5 (.020)	0.10 ± 0.10 (.004 $\pm .004$)	0.9 (.035)	1.0 (.039)	0.13 (.005)	3.8 (.150)	3.5 (.138)	3.5 (.138)
X	7343-43		7.3 ± 0.3 (.287 $\pm .012$)	4.3 ± 0.3 (.169 $\pm .012$)	4.0 ± 0.3 (.157 $\pm .012$)	2.3 (.091)	2.4 (.094)	1.3 (.051)	0.5 (.020)	0.10 ± 0.10 (.004 $\pm .004$)	1.7 (.067)	1.0 (.039)	0.13 (.005)	3.8 (.150)	3.5 (.138)	3.5 (.138)
E	7260-38		7.3 ± 0.3 (.287 $\pm .012$)	6.0 ± 0.3 (.236 $\pm .012$)	3.6 ± 0.2 (.142 $\pm .008$)	2.3 (.091)	4.1 (.161)	1.3 (.051)	0.5 (.020)	0.10 ± 0.10 (.004 $\pm .004$)	0.9 (.035)	1.0 (.039)	0.13 (.005)	3.8 (.150)	3.5 (.138)	3.5 (.138)

Notes: 1. Metric dimensions govern.
 2. (Ref) - Dimensions provided for reference only.
 * Mil-C-55365/8 Specified Dimensions

LOW PROFILE T491 DIMENSIONS

Millimeters (inches)

CASE SIZE	KEMET	EIA	COMPONENT										
			L	W	H Max.	K Min.	F ± 0.1	S ± 0.3	X (Ref)	T (Ref)	A (Min)	G (Ref)	E (Ref)
R	2012-12		2.0 ± 0.2 (.079 $\pm .008$)	1.3 ± 0.2 (.051 $\pm .008$)	1.2 (.047)	0.3 (.012)	0.9 (.035)	0.5 (.020)	0.05 (.002)	0.13 (.005)	0.8 (.031)	0.5 (.020)	0.8 (.031)
S	3216-12		3.2 ± 0.2 (.126 $\pm .008$)	1.6 ± 0.2 (.063 $\pm .008$)	1.2 (.047)	0.3 (.012)	1.2 (.047)	0.8 (.031)	0.05 (.002)	0.13 (.005)	1.4 (.055)	1.1 (.043)	1.3 (.051)
T	3528-12		3.5 ± 0.2 (.138 $\pm .008$)	2.8 ± 0.2 (.110 $\pm .008$)	1.2 (.047)	0.3 (.012)	2.2 (.087)	0.8 (.031)	0.05 (.002)	0.13 (.005)	2.1 (.083)	1.8 (.071)	2.2 (.087)
U	6032-15		6.0 ± 0.3 (.236 $\pm .012$)	3.2 ± 0.3 (.126 $\pm .012$)	1.5 (.059)	0.5 (.020)	2.2 (.087)	1.3 (.051)	0.05 (.002)	0.13 (.005)	3.1 (.122)	2.8 (.110)	2.4 (.094)
V	7343-20		7.3 ± 0.3 (.287 $\pm .012$)	4.3 ± 0.3 (.169 $\pm .012$)	2.0 (.079)	0.9 (.035)	2.4 (.094)	1.3 (.051)	0.05 (.002)	0.13 (.005)	3.8 (.150)	3.5 (.138)	3.5 (.138)

Notes: 1. Metric dimensions govern.
 2. (Ref) - Dimensions provided for reference only.
 3. No dimensions provided for B, P or R because low profile cases do not have a bevel or a notch.

T491 ORDERING INFORMATION

T **491** **B** **105** **M** **035** **A** **S***

Tantalum ———— **T**

Series ———— **491**
T491 - Precision Molded

Case Size ———— **B**
A, B, C, D, E, R, S, T, U, V, X

Capacitance Picofarad Code ———— **105**
First two digits represent significant figures.
Third digit specifies number of zeros to follow.

Part number example: T491B105M035AT (14 digits - no spaces). See www.kemet.com for Pb Free transition.

**** "S" Termination codes are converting from 90Sn/10 Pb to 100% tin finishes. Orders including "S" suffix termination codes do not guarantee Pb-free product.**

M ———— **Lead Material**
T = 100% Tin (Sn) Plated
H = Tin/Lead (SnPb 5% Pb minimum)
G = Gold Plated (A, B, C, D, X only)
****S = Not recommended for new designs**

035 ———— **Failure Rate**
A = Not Applicable

A ———— **Voltage**
As shown

S* ———— **Capacitance Tolerance**
M = $\pm 20\%$; K = $\pm 10\%$

***Pb-free supply is not guaranteed with the 'S' termination code. This termination code not available effective 15 July 2007.**



SOLID TANTALUM CHIP CAPACITORS

T491 SERIES—Precision Molded Chip

T491 TANTALUM CHIP CAPACITANCE VALUES

Case Size by Capacitance and Voltage

Capacitance		Rated Voltage @ +85°C									
µF	Code	2.5	3	4	6	10	16	20	25	35	50
0.10	104									A	A
0.15	154									A	A/B
0.22	224									A	B
0.33	334								A	A	B
0.47	474								A	A/B	B/C
0.68	684							A	A	A/B	B/C
1.0	105						A	R/S/A	A/B	A/B	V/C
1.5	155					A	A	S/A	A/B	B/C	C/D
2.2	225				R/A	A/B	R/S/A	A/B	B/C	B/C	C/D
3.3	335			A	A	R/S/A	A/B	T/A/B	B/C	B/C	D
4.7	475			A	S/A	A/B R/S	A/B/T	A/B/C	A/B/C	B/C/D	D
6.8	685			S/A	R/S A/B	S/T A/B	A/B/C	U/A/B/C	B/C	C/D	D/X
10.0	106			R/S A/B	R/S/T A/B	S/T/A B/C	B/C/U T/A	U/B/C	B/C/D	V/C/D	D/X
15.0	156			S/T A/B	S A/B/C	U A/B/C	U/A/B/C	C/D	C/D	C/D/X	X
22.0	226			S/T A/B/C	U/T A/B/C	T/U A/B/C	U/B C/D	V/C/D	V/C/D	D/X	
33.0	336		A	U A/B/C	T/U A/B/C	U/V B/C/D	U/C	V/C/D	D/X	X	
47.0	476			U A/B/C	T/U/A B/C/D	U/V B/C/D	V/C/D	D	D/X	X/E	
68.0	686			U/A B/C/D	U/B C/D	U/V B/C/D	V/D	D/X	D/X		
100.0	107	T		T/U/A B/C/D	U/V B/C/D	V/C/D	V/D/X	D/E			
150.0	157			V/B C/D	V/C/D	V/C D/X	D/X				
220.0	227			V/B	V D/X	V/D/X	X				
330.0	337			V/C/D	D/X	D/X/E					
470.0	477			D/X	D/X/E	X/E					
680.0	687			D/X	E						
1000.0	108			X/E							



SOLID TANTALUM CHIP CAPACITORS
T491 SERIES—Precision Molded Chip

T491 RATINGS & PART NUMBER REFERENCE

Table with columns: Capacitance µF, Case Size, KEMET Part Number, DC Leakage µA @ 25°C Max, DF % @ +25°C 120 Hz Max, ESR Ω @ +25°C 100 kHz Max. Includes sub-sections for 10 Volt Rating at +85°C and 16 Volt Rating at +85°C.

Table with columns: Capacitance µF, Case Size, KEMET Part Number, DC Leakage µA @ 25°C Max, DF % @ +25°C 120 Hz Max, ESR Ω @ +25°C 100 kHz Max. Includes sub-sections for 16 Volt Rating at +85°C, 20 Volt Rating at +85°C, and 25 Volt Rating at +85°C.

(1) To complete KEMET Part Number, insert M for ±20% tolerance or K for ±10% tolerance.
(2) To complete KEMET Part Number, insert T, H, G, or S lead material designation as shown on page 15.
*Extended Values
**6 Volt product equivalent to 6.3 volt product.
†Maximum Capacitance Change @ 125°C=+15%.
‡Maximum Capacitance Change @ 125°C=+20%.

Higher voltage ratings and tighter tolerance product may be substituted within the same size at KEMET's option. Voltage substitutions will be marked with the higher voltage rating.

SOLID TANTALUM CHIP CAPACITORS

T491 SERIES—Precision Molded Chip



T491 RATINGS & PART NUMBER REFERENCE

Capacitance µF	Case Size	KEMET Part Number	DC Leakage µA @ 25°C Max	DF % @ +25°C 120 Hz Max	ESR Ω @ +25°C 100 kHz Max
35 Volt Rating at +85°C (23 Volt Rating at +125°C)					
0.10	A	T491A104(1)035A(2)	0.5	4.0	20.0
0.15	A	T491A154(1)035A(2)	0.5	4.0	19.0
0.22	A	T491A224(1)035A(2)	0.5	4.0	18.0
0.33	A	T491A334(1)035A(2)	0.5	4.0	15.0
0.47	B	T491B474(1)035A(2)	0.5	4.0	8.0
0.47	A	T491A474(1)035A(2)	0.5	4.0	12.0
0.68	B	T491B684(1)035A(2)	0.5	4.0	6.5
0.68	A	T491A684(1)035A(2)	0.5	4.0	8.0
1.0	B	T491B105(1)035A(2)	0.5	4.0	5.0
1.0	A	T491A105(1)035A(2)	0.5	4.0	7.5
1.5	C	T491C155(1)035A(2)	0.5	6.0	4.5
1.5	B	T491B155(1)035A(2)	0.5	6.0	5.0
2.2	C	T491C225(1)035A(2)	0.8	6.0	3.5
2.2	B	T491B225(1)035A(2)	0.8	6.0	4.0
3.3	C	T491C335(1)035A(2)	1.2	6.0	2.5
#3.3	B	T491B335(1)035A(2)	1.2	6.0	3.5
4.7	D	T491D475(1)035A(2)	1.7	6.0	1.5
4.7	C	T491C475(1)035A(2)	1.7	6.0	2.2
4.7	B	T491B475(1)035A(2)	1.6	6.0	3.1
6.8	D	T491D685(1)035A(2)	2.4	6.0	1.3
6.8	C	T491C685(1)035A(2)	2.4	6.0	1.8
10.0	D	T491D106(1)035A(2)	3.5	6.0	1.0
#10.0	C	T491C106M035A(2)	3.5	6.0	1.6
#10.0	V	T491V106(1)035A(2)	3.5	6.0	2.0
15.0	X	T491X156(1)035A(2)	5.3	6.0	0.9
15.0	D	T491D156(1)035A(2)	5.3	6.0	0.8
22.0	X	T491X226(1)035A(2)	7.7	6.0	0.7
#22.0	D	T491D226(1)035A(2)	7.7	6.0	0.7
#33.0	X	T491X336(1)035A(2)	11.6	6.0	0.6
†47.0	X	T491X476(1)035A(2)	16.5	8.0	0.6
#47.0	E	T491E476(1)035A(2)	16.5	10.0	0.5
50 Volt Rating at +85°C (33 Volt Rating at +125°C)					
0.10	A	T491A104(1)050A(2)	0.5	4.0	20.0
0.15	B	T491B154(1)050A(2)	0.5	4.0	16.0
0.15	A	T491A154(1)050A(2)	0.5	4.0	15.0
0.22	B	T491B224(1)050A(2)	0.5	4.0	14.0
0.33	B	T491B334(1)050A(2)	0.5	4.0	10.0
0.47	C	T491C474(1)050A(2)	0.5	4.0	8.0
0.47	B	T491B474(1)050A(2)	0.5	4.0	9.0
0.68	C	T491C684(1)050A(2)	0.5	4.0	7.0
0.68	B	T491B684(1)050A(2)	0.5	4.0	8.0
1.0	C	T491C105(1)050A(2)	0.5	4.0	5.5
1.0	V	T491V105(1)050A(2)	0.5	4.0	6.0
1.5	D	T491D155(1)050A(2)	0.8	6.0	3.5
1.5	C	T491C155(1)050A(2)	0.8	6.0	4.5
2.2	D	T491D225(1)050A(2)	1.1	6.0	2.5
2.2	C	T491C225(1)050A(2)	1.1	6.0	3.0
3.3	D	T491D335(1)050A(2)	1.7	6.0	2.0
4.7	D	T491D475(1)050A(2)	2.4	6.0	1.4
6.8	X	T491X685(1)050A(2)	3.5	6.0	1.0
#6.8	D	T491D685(1)050A(2)	3.4	6.0	1.0
#10.0	X	T491X106M050A(2)	5.0	6.0	0.7
#10.0	D	T491D106(1)050A(2)	5.0	6.0	0.8
†15.0	X	T491X156(1)050A(2)	7.5	8.0	0.7

CONSTRUCTION

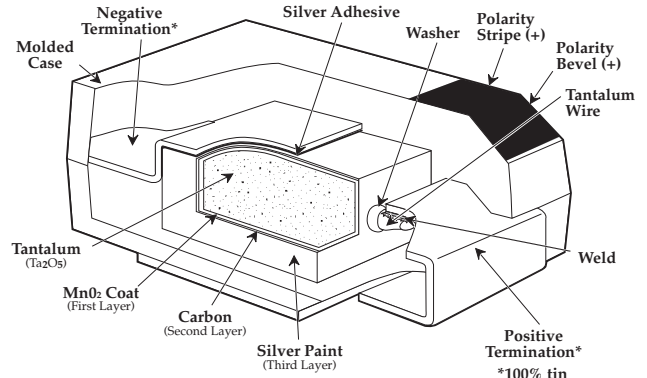

CAPACITOR MARKINGS

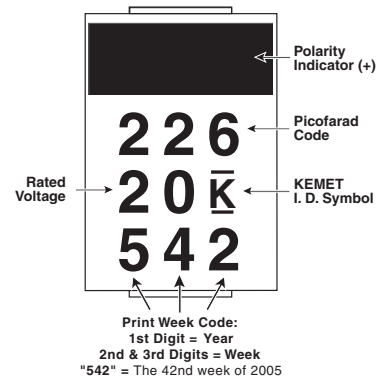

(1) To complete KEMET Part Number, insert M for ±20% tolerance or K for ±10% tolerance.
 (2) To complete KEMET Part Number, insert T, H, G, or S lead material designation as shown on page 15.
 *Extended Values
 **6 Volt product equivalent to 6.3 volt product.
 #Maximum Capacitance Change @ 125°C=+15%.
 †Maximum Capacitance Change @ 125°C=+20%.
 Higher voltage ratings and tighter tolerance product may be substituted within the same size at KEMET's option.
 Voltage substitutions will be marked with the higher voltage rating.

CAPACITOR ALTERNATE MARKINGS

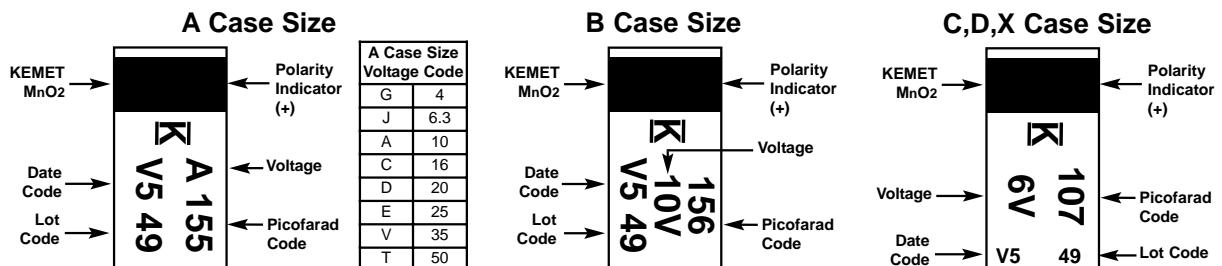

Date Code - Year			Date Code - Month			
S = 2004	V = 2007	1 = January	4 = April	7 = July	10 = October	
T = 2005	W = 2008	2 = February	5 = May	8 = August	11 = November	
U = 2006	X = 2009	3 = March	6 = June	9 = September	12 = December	

SOLID TANTALUM CHIP CAPACITORS

T492 SERIES – Style CWR11 Per Mil-PRF-55365/8

- Established reliability military version of Industrial Grade T491 series
- Taped and reeled per EIA 481-1
- Precision-molded, laser-marked case
- Symmetrical, compliant terminations
- 100% Surge Current test available for all case sizes
- Operating Temperature: -55°C to + 125°C
- Qualified to MIL-PRF-55365/8, Style CWR11:
 - Termination Options B, C, H, K
 - Weibull failure rate codes B, C and D
 - Capacitance values and voltages as shown in following part number table. (Contact KEMET for latest qualification status)

T492 OUTLINE DRAWINGS

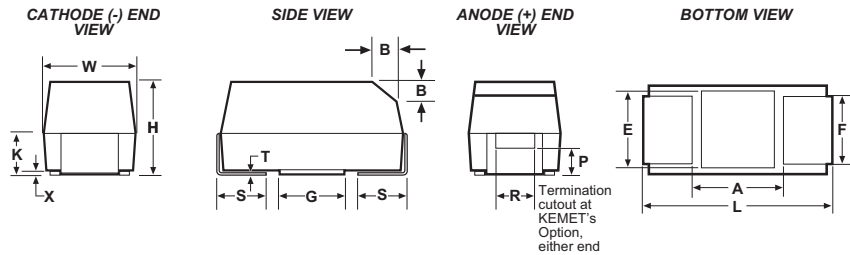

DIMENSIONS – Millimeters (Inches)

Case Size		Component													
KEMET	EIA	L*	W*	H*	K* ± 0.20 ± (.008)	F* ± 0.1 ± (.004)	S* ± 0.3 ± (.012)	B ± 0.15 (Ref) ± .006	X (Ref)	P (Ref)	R (Ref)	T (Ref)	A (Min)	G (Ref)	E (Ref)
A	3216-18	3.2 ± 0.2 (.126 ± .008)	1.6 ± 0.2 (.063 ± .008)	1.6 ± 0.2 (.063 ± .008)	0.9 (.035)	1.2 (.047)	0.8 (.031)	0.4 (.016)	0.10 ± 0.10 (.004 ± .004)	0.4 (.016)	0.4 (.016)	0.13 (.005)	1.4 (.055)	1.1 (.043)	1.3 (.051)
B	3528-21	3.5 ± 0.2 (.138 ± .008)	2.8 ± 0.2 (.110 ± .008)	1.9 ± 0.2 (.075 ± .008)	1.1 (.043)	2.2 (.087)	0.8 (.031)	0.4 (.016)	0.10 ± 0.10 (.004 ± .004)	0.5 (.020)	1.0 (.039)	0.13 (.005)	2.1 (.083)	1.8 (.071)	2.2 (.087)
C	6032-28	6.0 ± 0.3 (.236 ± .012)	3.2 ± 0.3 (.126 ± .012)	2.5 ± 0.3 (.098 ± .012)	1.4 (.055)	2.2 (.087)	1.3 (.051)	0.5 (.020)	0.10 ± 0.10 (.004 ± .004)	0.9 (.035)	1.0 (.039)	0.13 (.005)	3.1 (.122)	2.8 (.110)	2.4 (.094)
D	7343-31	7.3 ± 0.3 (.287 ± .012)	4.3 ± 0.3 (.169 ± .012)	2.8 ± 0.3 (.110 ± .012)	1.5 (.059)	2.4 (.094)	1.3 (.051)	0.5 (.020)	0.10 ± 0.10 (.004 ± .004)	0.9 (.035)	1.0 (.039)	0.13 (.005)	3.8 (.150)	3.5 (.138)	3.5 (.138)

Notes: 1. Metric dimensions govern
 2. (Ref) Dimensions provided for reference only
 * Mil-PRF-55365/8 Specified Dimensions

ORDERING INFORMATION — MIL-PRF-55365 Part Number

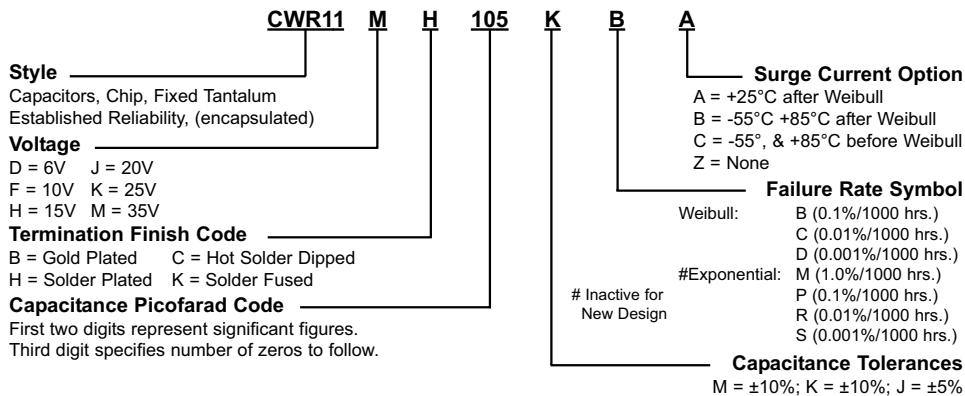

T492 SERIES ORDERING INFORMATION — KEMET Part Number

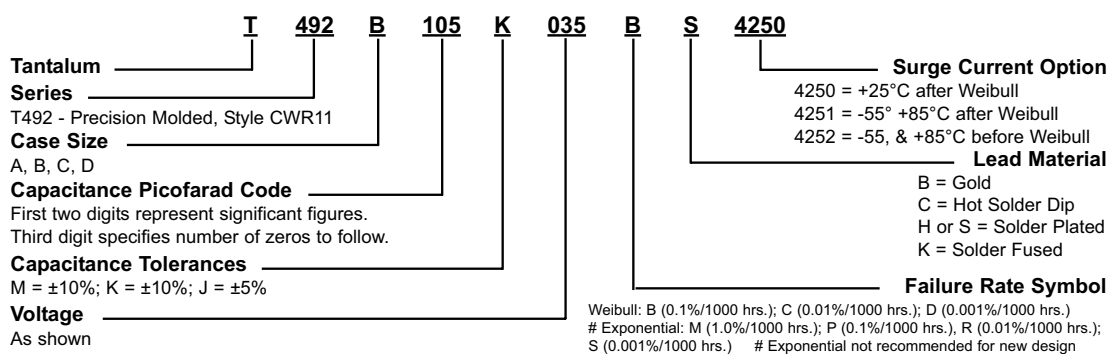

* Part Number Example: T492B105K035BS (14 digits - no spaces)
 * See www.kemet.com for Pb Free transition.

Note on Failure Rates: Exponential failure rate levels M, P, R and S are inactive for new design per Mil-C-55365. Parts qualified to Weibull failure rate levels are substitutable for exponential failure rate levels.

SOLID TANTALUM CHIP CAPACITORS

T492 SERIES—Style CWR11 Per Mil-PRF-55365/8



T492 (CWR11) RATINGS AND PART NUMBER REFERENCE

Capacitance μF	Case Size	KEMET Part Number	Mil-C-55365/8 Part Number	DCL μA @ +25°C Max	DF % @ +25°C 120 Hz Max	ESR Ω @ +25°C 100kHz Max
6 Volt Rating at +85°C (4 Volt Rating at +125°C)						
1.5	A	T492A155(1)006(2)(3)(4)	CWR11D(6)155(1)(2)(5)	0.5	6.0	8.0
2.2	A	T492A225(1)006(2)(3)(4)	CWR11D(6)225(1)(2)(5)	0.5	6.0	8.0
3.3	A	T492A335(1)006(2)(3)(4)	CWR11D(6)335(1)(2)(5)	0.5	6.0	8.0
4.7	B	T492B475(1)006(2)(3)(4)	CWR11D(6)475(1)(2)(5)	0.5	6.0	5.5
6.8	B	T492B685(1)006(2)(3)(4)	CWR11D(6)685(1)(2)(5)	0.5	6.0	4.5
10.0	B	T492B106(1)006(2)(3)(4)	CWR11D(6)106(1)(2)(5)	0.6	6.0	3.5
15.0	C	T492C156(1)006(2)(3)(4)	CWR11D(6)156(1)(2)(5)	0.9	6.0	3.0
22.0	C	T492C226(1)006(2)(3)(4)	CWR11D(6)226(1)(2)(5)	1.4	6.0	2.2
47.0	D	T492D476(1)006(2)(3)(4)	CWR11D(6)476(1)(2)(5)	2.8	6.0	1.1
10 Volt Rating at +85°C (7 Volt Rating at 125°C)						
1.0	A	T492A105(1)010(2)(3)(4)	CWR11F(6)105(1)(2)(5)	0.5	4.0	10.0
1.5	A	T492A155(1)010(2)(3)(4)	CWR11F(6)155(1)(2)(5)	0.5	6.0	8.0
2.2	A	T492A225(1)010(2)(3)(4)	CWR11F(6)225(1)(2)(5)	0.5	6.0	8.0
3.3	B	T492B335(1)010(2)(3)(4)	CWR11F(6)335(1)(2)(5)	0.5	6.0	5.5
4.7	B	T492B475(1)010(2)(3)(4)	CWR11F(6)475(1)(2)(5)	0.5	6.0	4.5
6.8	B	T492B685(1)010(2)(3)(4)	CWR11F(6)685(1)(2)(5)	0.7	6.0	3.5
15.0	C	T492C156(1)010(2)(3)(4)	CWR11F(6)156(1)(2)(5)	1.5	6.0	2.5
33.0	D	T492D336(1)010(2)(3)(4)	CWR11F(6)336(1)(2)(5)	3.3	6.0	1.1
15 Volt Rating at +85°C (10 Volt Rating at +125°C)						
0.7	A	T492A684(1)015(2)(3)(4)	CWR11H(6)684(1)(2)(5)	0.5	4.0	12.0
1.0	A	T492A105(1)015(2)(3)(4)	CWR11H(6)105(1)(2)(5)	0.5	4.0	10.0
1.5	A	T492A155(1)015(2)(3)(4)	CWR11H(6)155(1)(2)(5)	0.5	6.0	8.0
2.2	B	T492B225(1)015(2)(3)(4)	CWR11H(6)225(1)(2)(5)	0.5	6.0	5.5
3.3	B	T492B335(1)015(2)(3)(4)	CWR11H(6)335(1)(2)(5)	0.5	6.0	5.0
4.7	B	T492B475(1)015(2)(3)(4)	CWR11H(6)475(1)(2)(5)	0.7	6.0	4.0
10.0	C	T492C106(1)015(2)(3)(4)	CWR11H(6)106(1)(2)(5)	1.6	6.0	2.5
22.0	D	T492D226(1)015(2)(3)(4)	CWR11H(6)226(1)(2)(5)	3.3	6.0	1.1
20 Volt Rating at +85°C (13 Volt Rating at +125°C)						
0.5	A	T492A474(1)020(2)(3)(4)	CWR11J(6)474(1)(2)(5)	0.5	4.0	14.0
0.7	A	T492A684(1)020(2)(3)(4)	CWR11J(6)684(1)(2)(5)	0.5	4.0	12.0
1.0	A	T492A105(1)020(2)(3)(4)	CWR11J(6)105(1)(2)(5)	0.5	4.0	10.0
1.5	B	T492B155(1)020(2)(3)(4)	CWR11J(6)155(1)(2)(5)	0.5	6.0	6.0
2.2	B	T492B225(1)020(2)(3)(4)	CWR11J(6)225(1)(2)(5)	0.5	6.0	5.0
3.3	B	T492B335(1)020(2)(3)(4)	CWR11J(6)335(1)(2)(5)	0.7	6.0	4.0
4.7	C	T492C475(1)020(2)(3)(4)	CWR11J(6)475(1)(2)(5)	1.0	6.0	3.0
6.8	C	T492C685(1)020(2)(3)(4)	CWR11J(6)685(1)(2)(5)	1.4	6.0	2.4
15.0	D	T492D156(1)020(2)(3)(4)	CWR11J(6)156(1)(2)(5)	3.0	6.0	1.1
25 Volt Rating at +85°C (17 Volt Rating at +125°C)						
0.3	A	T492A334(1)025(2)(3)(4)	CWR11K(6)334(1)(2)(5)	0.5	4.0	15.0
0.5	A	T492A474(1)025(2)(3)(4)	CWR11K(6)474(1)(2)(5)	0.5	4.0	14.0
0.7	B	T492B684(1)025(2)(3)(4)	CWR11K(6)684(1)(2)(5)	0.5	4.0	7.5
1.0	B	T492B105(1)025(2)(3)(4)	CWR11K(6)105(1)(2)(5)	0.5	4.0	6.5
1.5	B	T492B155(1)025(2)(3)(4)	CWR11K(6)155(1)(2)(5)	0.5	6.0	6.5
2.2	C	T492C225(1)025(2)(3)(4)	CWR11K(6)225(1)(2)(5)	0.6	6.0	3.5
3.3	C	T492C335(1)025(2)(3)(4)	CWR11K(6)335(1)(2)(5)	0.9	6.0	3.5
4.7	C	T492C475(1)025(2)(3)(4)	CWR11K(6)475(1)(2)(5)	1.2	6.0	2.5
6.8	D	T492D685(1)025(2)(3)(4)	CWR11K(6)685(1)(2)(5)	1.7	6.0	1.4
10.0	D	T492D106(1)025(2)(3)(4)	CWR11K(6)106(1)(2)(5)	2.5	6.0	1.2
35 Volt Rating at +85°C (23 Volt Rating at +125°C)						
0.1	A	T492A104(1)035(2)(3)(4)	CWR11M(6)104(1)(2)(5)	0.5	4.0	24.0
0.2	A	T492A154(1)035(2)(3)(4)	CWR11M(6)154(1)(2)(5)	0.5	4.0	21.0
0.2	A	T492A224(1)035(2)(3)(4)	CWR11M(6)224(1)(2)(5)	0.5	4.0	18.0
0.3	A	T492A334(1)035(2)(3)(4)	CWR11M(6)334(1)(2)(5)	0.5	4.0	15.0
0.5	B	T492B474(1)035(2)(3)(4)	CWR11M(6)474(1)(2)(5)	0.5	4.0	10.0
0.7	B	T492B684(1)035(2)(3)(4)	CWR11M(6)684(1)(2)(5)	0.5	4.0	8.0
1.0	B	T492B105(1)035(2)(3)(4)	CWR11M(6)105(1)(2)(5)	0.5	4.0	6.5
1.5	C	T492C155(1)035(2)(3)(4)	CWR11M(6)155(1)(2)(5)	0.5	6.0	4.5
2.2	C	T492C225(1)035(2)(3)(4)	CWR11M(6)225(1)(2)(5)	0.8	6.0	3.5
3.3	C	T492C335(1)035(2)(3)(4)	CWR11M(6)335(1)(2)(5)	1.2	6.0	2.5
4.7	D	T492D475(1)035(2)(3)(4)	CWR11M(6)475(1)(2)(5)	1.7	6.0	1.5

PACKAGING

Note: T492 Packaging

- No c-spec required for 7" reel packaging
 - C-7280 required for 13" reel packaging
 - Standard reel packaging is not mandatory
 - Bulk packaging also available using C-7610
- See page 91 for tape and reel quantities.

CONSTRUCTION

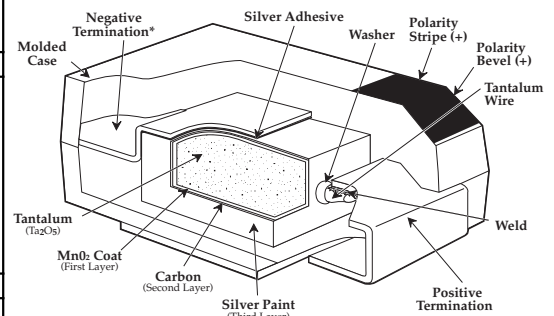

CAPACITOR MARKINGS

T492 Series — All Case Sizes

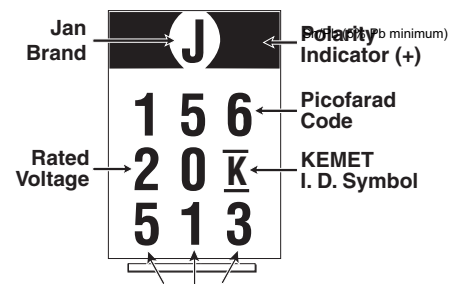

Print Week Code:
 1st Digit = Year
 2nd & 3rd Digits = Week
 "513" = The 13th week of 2005

Note on Failure Rates:
 Exponential failure rate levels M, P, R and S are inactive for new design per MLL-C-55365. Parts qualified to Weibull failure rate levels are substitutable for exponential failure rate levels.

Note: ESR limits are per Mil-C-55365/8

(1) To complete KEMET/CWR part number, insert M for $\pm 20\%$, K for $\pm 10\%$ or J for $\pm 5\%$ tolerance.
 (2) To complete KEMET/CWR part number, insert Failure Rate Symbol Weibull: B (0.1%/1000 Hrs.), C (0.01%/1000Hrs or D (0.001%/1000 Hrs.), Exponential: M (1.0%/1000 hrs.), P (0.1%/1000 hrs.), R (0.01%/1000 hrs.) or S (0.001%/1000 hrs.)
 (3) To complete KEMET part number, insert Termination Finish Designation B = Gold; C = Hot Solder Dipped; S = Solder Plated; K = Solder Fused.
 (4) To complete KEMET part number, insert 4250 = +25°C after Weibull; 4251 = -55° + 85°C after Weibull; or 4252 = -55, & +85°C before Weibull Surge Current Option.
 (5) To complete CWR part number, insert A = +25°C after Weibull; B = -55° + 85°C after Weibull; C = -55°, & + 85°C before Weibull or Z = None for Surge Current Option.
 (6) To complete CWR part numbers, insert B = Gold; C = Hot Solder Dipped; H or S = Solder Plated; K = Solder Fused

FEATURES

- Standard Cases Sizes A - X per EIA535BAAC
- Termination Finishes offered per MIL-PRF-55365: Gold Plated, Hot Solder Dipped, Solder Plated, Solder Fused, 100% Tin
- Weibull Grading Available: B (0.1%/1000hrs) and C (0.01%/1000hrs)
- Surge Current Testing Available per MIL-PRF-55365: 10 cycles @ +25°C; 10 cycles @ -55°C and +85°C
- Standard and Low ESR Options
- Operating Temperature Range: -55°C to +125°C
- Capacitance: 0.1 to 330µF
- Voltage: 4 to 50 Volts

OUTLINE DRAWING

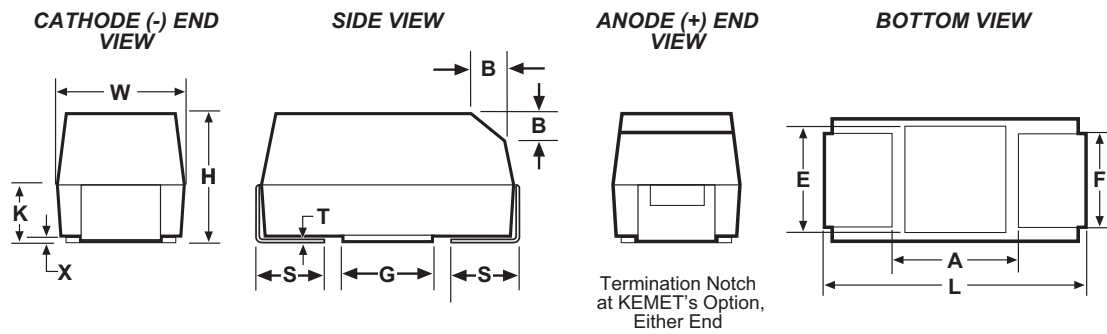

DIMENSIONS- MILLIMETERS (INCHES)

Case Size		L	W	H	K ±0.20	F ±0.1	S ±0.3	B ±0.15 (Ref) ±(.006)	X (Ref)	P (Ref)	R (Ref)	A (Min)	G (Ref)	E (Ref)
KEMET	EIA													
A	3216-18	3.2 ± 0.2 (.126 ± .008)	1.6 ± 0.2 (.063 ± .008)	1.6 ± 0.2 (.063 ± .008)	0.9 (.035)	1.2 (.047)	0.8 (.031)	0.4 (.016)	0.10 ± 0.10 (.004 ± .004)	0.4 (.016)	0.4 (.016)	1.4 (.055)	1.1 (.043)	1.3 (.051)
B	3528-21	3.5 ± 0.2 (.138 ± .008)	2.8 ± 0.2 (.110 ± .008)	1.9 ± 0.1 (.075 ± .008)	1.1 (.043)	2.2 (.087)	0.8 (.031)	0.4 (.016)	0.10 ± 0.10 (.004 ± .004)	0.5 (.020)	1.0 (.039)	2.1 (.083)	1.8 (.071)	2.2 (.087)
C	6032-28	6.0 ± 0.3 (.236 ± .012)	3.2 ± 0.3 (.126 ± .12)	2.5 ± 0.3 (.098 ± .012)	1.4 (.055)	2.2 (.087)	1.3 (.051)	0.5 (.020)	0.10 ± 0.10 (.004 ± .004)	0.9 (.0235)	1.0 (.039)	3.1 (.122)	2.8 (.110)	2.4 (.094)
D	7343-31	7.3 ± 0.3 (.287 ± .012)	4.3 ± 0.3 (.169 ± .012)	2.8 ± 0.3 (.110 ± .012)	1.5 (.059)	2.4 (.094)	1.3 (.051)	0.5 (.020)	0.10 ± 0.10 (.004 ± .004)	0.9 (.0235)	1.0 (.039)	3.8 (.150)	3.5 (.138)	3.5 (.138)
X	7343-43	7.3 ± 0.3 (.287 ± .012)	4.3 ± 0.3 (.169 ± .012)	4.0 ± 0.3 (.157 ± .012)	2.3 (.091)	2.4 (.094)	1.3 (.051)	0.5 (.020)	0.10 ± 0.10 (.004 ± .004)	1.7 (.067)	1.0 (.039)	3.8 (.150)	3.5 (.138)	3.5 (.138)
E	7260-38	7.3 ± 0.3 (.287 ± .012)	6.0 ± 0.3 (.236 ± .012)	3.6 ± 0.2 (.142 ± .008)	2.3 (.091)	4.1 (.161)	1.3 (.051)	0.5 (.020)	0.10 ± 0.10 (.004 ± .004)	0.9 (.035)	1.0 (.039)	3.8 (.150)	3.5 (.138)	3.5 (.138)

- Notes: 1. Metric dimensions govern.
2. (ref) - Dimensions provided for reference only.

COMPONENT MARKING

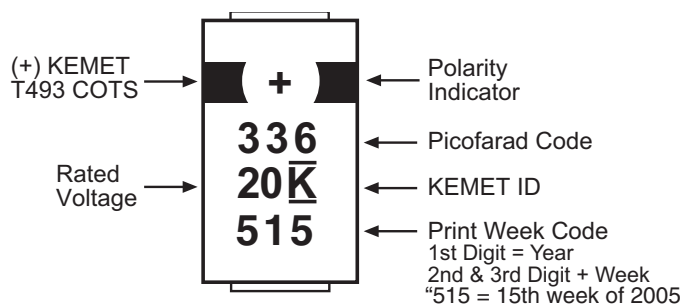

SOLID TANTALUM CHIP CAPACITORS

T493 SERIES—Military COTS



ORDERING INFORMATION

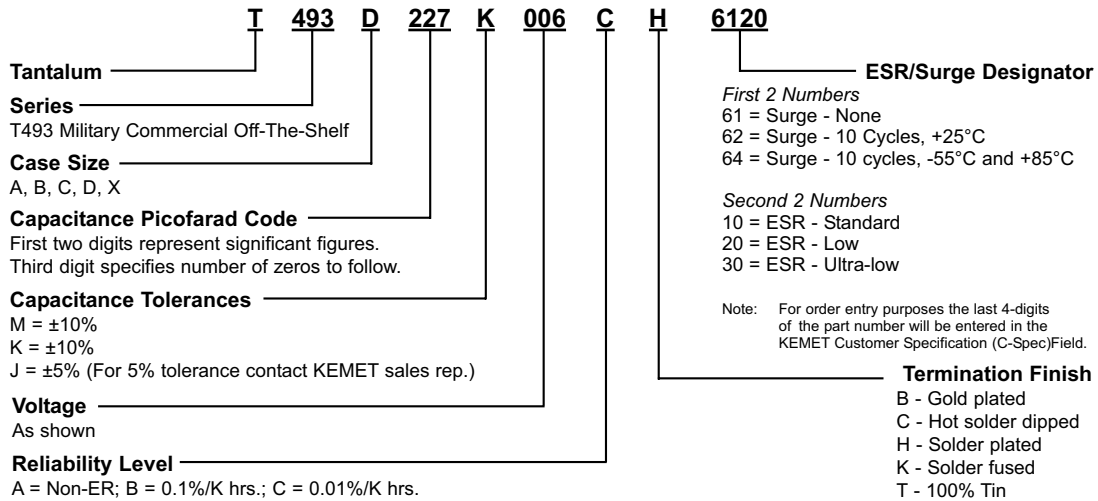

Solid Tantalum Surface Mount

T493 RATINGS AND PART NUMBER REFERENCE

Capacitance µF	Case Size	KEMET Part Number	DCL µA @ 25°C Max	DF % @ +25°C 120 Hz Max	Std. ESR Ohms @+25°C 100 kHz Max	Low ESR Ohms @+25°C Max	Ultra-Low ESR, Ohms @+25°C Max
4 Volt Rating at +85°C (2.7 Volt Rating at +125°C)							
2.2	A	T493A225(1)004(2)(3)(4)(5)	0.5	6.0	8.0	6.0	N/A
3.3	A	T493A335(1)004(2)(3)(4)(5)	0.5	6.0	8.0	4.0	N/A
4.7	A	T493A475(1)004(2)(3)(4)(5)	0.5	6.0	8.0	3.5	N/A
6.8	A	T493A685(1)004(2)(3)(4)(5)	0.5	6.0	6.0	3.0	N/A
6.8	B	T493B685(1)004(2)(3)(4)(5)	0.5	6.0	5.5	2.0	N/A
10.0	A	T493A106(1)004(2)(3)(4)(5)	0.5	6.0	6.0	2.0	N/A
10.0	B	T493B106(1)004(2)(3)(4)(5)	0.5	6.0	3.5	1.2	N/A
15.0	A	T493A156(1)004(2)(3)(4)(5)	0.6	6.0	4.0	1.5	N/A
15.0	B	T493B156(1)004(2)(3)(4)(5)	0.6	6.0	3.5	1.2	N/A
22.0	A	T493A226(1)004(2)(3)(4)(5)	0.9	6.0	4.0	1.5	N/A
22.0	B	T493B226(1)004(2)(3)(4)(5)	0.9	6.0	3.5	0.5	N/A
22.0	C	T493C226(1)004(2)(3)(4)(5)	0.9	6.0	1.8	0.5	N/A
33.0	A	T493A336(1)004(2)(3)(4)(5)	1.3	6.0	4.0	3.0	N/A
33.0	B	T493B336(1)004(2)(3)(4)(5)	1.3	6.0	3.5	0.5	N/A
33.0	C	T493C336(1)004(2)(3)(4)(5)	1.3	6.0	1.8	0.5	N/A
47.0	B	T493B476(1)004(2)(3)(4)(5)	1.9	6.0	3.0	0.5	N/A
47.0	C	T493C476(1)004(2)(3)(4)(5)	1.9	6.0	1.8	0.5	N/A
68.0	B	T493B686(1)004(2)(3)(4)(5)	2.7	6.0	3.5	2.0	N/A
68.0	C	T493C686(1)004(2)(3)(4)(5)	2.7	6.0	1.6	0.25	N/A
68.0	D	T493D686(1)004(2)(3)(4)(5)	2.7	6.0	0.8	0.2	N/A
#100.0	B	T493B107(1)004(2)(3)(4)(5)	4.0	8.0	1.0	0.7	0.50
100.0	C	T493C107(1)004(2)(3)(4)(5)	4.0	8.0	1.2	0.2	N/A
100.0	D	T493D107(1)004(2)(3)(4)(5)	4.0	8.0	0.8	0.2	N/A
#150.0	C	T493C157(1)004(2)(3)(4)(5)	6.0	8.0	1.2	0.3	0.25
150.0	D	T493D157(1)004(2)(3)(4)(5)	6.0	8.0	0.8	0.15	N/A
220.0	D	T493D227(1)004(2)(3)(4)(5)	8.8	8.0	0.9	0.7	N/A
330.0	D	T493D337(1)004(2)(3)(4)(5)	13.2	8.0	0.7	0.15	N/A
330.0	X	T493X337(1)004(2)(3)(4)(5)	13.2	8.0	0.5	0.2	N/A
6 Volt Rating at +85°C (4 Volt Rating at +125°C)							
1.5	A	T493A155(1)006(2)(3)(4)(5)	0.5	6.0	8.0	6.0	N/A
2.2	A	T493A225(1)006(2)(3)(4)(5)	0.5	6.0	8.0	6.0	N/A
3.3	A	T493A335(1)006(2)(3)(4)(5)	0.5	6.0	8.0	6.0	N/A
4.7	A	T493A475(1)006(2)(3)(4)(5)	0.5	6.0	6.0	3.5	N/A
4.7	B	T493B475(1)006(2)(3)(4)(5)	0.5	6.0	5.5	3.5	N/A
6.8	A	T493A685(1)006(2)(3)(4)(5)	0.5	6.0	6.0	2.0	N/A
6.8	B	T493B685(1)006(2)(3)(4)(5)	0.5	6.0	3.5	1.2	N/A
10.0	A	T493A106(1)006(2)(3)(4)(5)	0.6	6.0	4.0	2.0	N/A
10.0	B	T493B106(1)006(2)(3)(4)(5)	0.6	6.0	3.5	1.0	N/A
15.0	A	T493A156(1)006(2)(3)(4)(5)	0.9	6.0	4.0	1.5	N/A
15.0	B	T493B156(1)006(2)(3)(4)(5)	0.9	6.0	3.5	0.7	N/A
15.0	C	T493C156(1)006(2)(3)(4)(5)	0.9	6.0	1.8	0.6	N/A
22.0	A	T493A226(1)006(2)(3)(4)(5)	1.4	6.0	4.0	3.0	N/A
22.0	B	T493B226(1)006(2)(3)(4)(5)	1.4	6.0	3.5	0.6	N/A
22.0	C	T493C226(1)006(2)(3)(4)(5)	1.4	6.0	1.8	0.5	N/A

- To complete KEMET part number, insert M for ±20% or K for ±10% capacitance tolerance. To request ±5% tolerance, contact KEMET sales representative.
 - To complete KEMET part number, insert A for Non-ER; B for 0.1%/1000 Hrs.; or C for 0.01%/1000 Hrs. Reliability Level.
 - To complete KEMET part number, insert B for Gold Plated (50 µ inch minimum); C for Hot Solder Dipped (60 µ inch minimum); H for Solder Plated (100 µ inch minimum); K for Solder Fused (60 µ inch minimum Termination Finish or T for 100% Tin.
 - To complete KEMET part number for Surge Current testing, insert 61 for none; 62 for 10 cycles +25°C; or 64 for 10 cycles, -55°C & +85°C.
 - To complete KEMET part number, insert 10 for Standard ESR; 20 for Low ESR or 30 for Ultra-low ESR Option.
- * Extended Values #Maximum Capacitance Change @ 125°C = +15%



SOLID TANTALUM CHIP CAPACITORS

T493 SERIES—Military COTS

T493 RATINGS AND PART NUMBER REFERENCE

Capacitance μF	Case Size	KEMET Part Number	DCL μA @ 25°C Max	DF % @ +25°C 120 Hz Max	Std. ESR Ohms @+25°C 100 kHz Max	Low ESR Ohms @+25°C 100 kHz Max	Ultra-Low ESR, Ohms @+25°C 100 kHz Max
6 Volt Rating at +85°C (4 Volt Rating at +125°C) cont.							
33.0	B	T493B336(1)006(2)(3)(4)(5)	2.0	6.0	3.0	0.6	N/A
33.0	C	T493C336(1)006(2)(3)(4)(5)	2.0	6.0	1.8	0.3	N/A
47.0	B	T493B476(1)006(2)(3)(4)(5)	2.9	6.0	3.5	2.0	N/A
47.0	C	T493C476(1)006(2)(3)(4)(5)	2.9	6.0	1.6	0.25	0.25
47.0	D	T493D476(1)006(2)(3)(4)(5)	2.9	6.0	0.8	0.22	N/A
68.0	B	T493B686(1)006(2)(3)(4)(5)	4.1	8.0	1.0	0.65	N/A
68.0	C	T493C686(1)006(2)(3)(4)(5)	4.1	6.0	1.2	0.2	N/A
68.0	D	T493D686(1)006(2)(3)(4)(5)	4.1	6.0	0.8	0.2	0.18
#100.0	B	T493B107(1)006(2)(3)(4)(5)	6.3	15.0	10.0	8.0	0.70
100.0	C	T493C107(1)006(2)(3)(4)(5)	6.0	8.0	1.2	0.3	0.15
100.0	D	T493D107(1)006(2)(3)(4)(5)	6.0	8.0	0.8	0.15	N/A
#150.0	C	T493C157(1)006(2)(3)(4)(5)	9.0	8.0	1.2	0.3	0.20
150.0	D	T493D157(1)006(2)(3)(4)(5)	9.0	8.0	0.7	0.15	N/A
#220.0	C	T493C227(1)006(2)(3)(4)(5)	13.2	10.0	1.2	0.3	0.23
220.0	D	T493D227(1)006(2)(3)(4)(5)	13.2	8.0	0.7	0.1	0.10
220.0	X	T493X227(1)006(2)(3)(4)(5)	13.2	8.0	0.7	0.15	0.07
330.0	D	T493D337(1)006(2)(3)(4)(5)	19.8	8.0	0.5	0.15	0.10
330.0	X	T493X337(1)006(2)(3)(4)(5)	19.8	8.0	0.5	0.1	0.07
1.0	A	T493A105(1)010(2)(3)(4)(5)	0.5	4.0	10.0	6.0	N/A
1.5	A	T493A155(1)010(2)(3)(4)(5)	0.5	6.0	8.0	6.0	N/A
2.2	A	T493A225(1)010(2)(3)(4)(5)	0.5	6.0	8.0	6.0	N/A
3.3	A	T493A335(1)010(2)(3)(4)(5)	0.5	6.0	6.0	4.0	N/A
3.3	B	T493B335(1)010(2)(3)(4)(5)	0.5	6.0	5.5	3.5	N/A
4.7	A	T493A475(1)010(2)(3)(4)(5)	0.5	6.0	6.0	3.0	N/A
4.7	B	T493B475(1)010(2)(3)(4)(5)	0.5	6.0	3.5	1.5	1.3
6.8	A	T493A685(1)010(2)(3)(4)(5)	0.7	6.0	6.0	3.0	N/A
6.8	B	T493B685(1)010(2)(3)(4)(5)	0.7	6.0	3.5	1.2	0.90
10.0	A	T493A106(1)010(2)(3)(4)(5)	1.0	6.0	4.0	1.8	N/A
10.0	B	T493B106(1)010(2)(3)(4)(5)	1.0	6.0	3.5	0.8	0.75
10.0	C	T493C106(1)010(2)(3)(4)(5)	1.0	6.0	1.8	0.6	N/A
#15.0	A	T493A156(1)010(2)(3)(4)(5)	1.5	8.0	6.0	4.0	3.2
15.0	B	T493B156(1)010(2)(3)(4)(5)	1.5	6.0	3.5	0.7	N/A
15.0	C	T493C156(1)010(2)(3)(4)(5)	1.5	6.0	1.8	0.5	0.48
22.0	B	T493B226(1)010(2)(3)(4)(5)	2.2	6.0	3.0	0.7	N/A
22.0	C	T493C226(1)010(2)(3)(4)(5)	2.2	6.0	1.8	0.4	0.29
33.0	B	T493B336(1)010(2)(3)(4)(5)	3.3	6.0	3.5	2.0	N/A
33.0	C	T493C336(1)010(2)(3)(4)(5)	3.3	6.0	1.6	0.3	N/A
33.0	D	T493D336(1)010(2)(3)(4)(5)	3.3	6.0	0.8	0.3	N/A
47.0	C	T493C476(1)010(2)(3)(4)(5)	4.7	6.0	1.2	0.3	N/A
47.0	D	T493D476(1)010(2)(3)(4)(5)	4.7	6.0	0.8	0.2	0.08
68.0	C	T493C686(1)010(2)(3)(4)(5)	6.8	6.0	1.2	0.3	0.23
68.0	D	T493D686(1)010(2)(3)(4)(5)	6.8	6.0	0.8	0.2	0.09
68.0	X	T493X686(1)010(2)(3)(4)(5)	5.4	4.0	0.5	0.15	0.15
#100.0	C	T493C107(1)010(2)(3)(4)(5)	10.0	8.0	1.2	0.3	N/A
100.0	D	T493D107(1)010(2)(3)(4)(5)	10.0	8.0	0.7	0.1	0.08
150.0	D	T493D157(1)010(2)(3)(4)(5)	15.0	8.0	0.7	0.1	0.08
150.0	X	T493X157(1)010(2)(3)(4)(5)	15.0	8.0	0.7	0.2	0.09
#220.0	D	T493D227(1)010(2)(3)(4)(5)	22.0	8.0	0.5	0.2	0.08
220.0	X	T493X227(1)010(2)(3)(4)(5)	22.0	8.0	0.5	0.1	0.05
330.0	X	T493X337(1)010(2)(3)(4)(5)	33.0	10.0	0.5	0.1	0.05
16 Volt Rating at +85°C (10 Volt Rating at +125°C)							
0.68	A	T493A684(1)016(2)(3)(4)(5)	1.1	6.0	12.0	8.0	N/A
1.0	A	T493A105(1)016(2)(3)(4)(5)	0.5	4.0	10.0	6.0	N/A
1.5	A	T493A155(1)016(2)(3)(4)(5)	0.5	6.0	8.0	6.0	N/A
2.2	A	T493A225(1)016(2)(3)(4)(5)	0.5	6.0	6.0	4.0	N/A
3.3	A	T493A335(1)016(2)(3)(4)(5)	0.5	6.0	6.0	3.5	N/A
3.3	B	T493B335(1)016(2)(3)(4)(5)	0.5	6.0	3.5	2.0	N/A
4.7	A	T493A475(1)016(2)(3)(4)(5)	0.8	6.0	6.0	3.0	N/A
4.7	B	T493B475(1)016(2)(3)(4)(5)	0.8	6.0	3.5	1.5	N/A
#6.8	A	T493A685(1)016(2)(3)(4)(5)	1.1	6.0	7.0	3.0	N/A
6.8	B	T493B685(1)016(2)(3)(4)(5)	1.1	6.0	3.5	1.2	N/A
6.8	C	T493C685(1)016(2)(3)(4)(5)	1.1	6.0	1.9	0.8	0.75
10.0	B	T493B106(1)016(2)(3)(4)(5)	1.6	6.0	3.5	0.8	N/A
10.0	C	T493C106(1)016(2)(3)(4)(5)	1.6	6.0	1.8	0.6	N/A
#15.0	B	T493B156(1)016(2)(3)(4)(5)	2.4	6.0	3.0	0.8	0.80
15.0	C	T493C156(1)016(2)(3)(4)(5)	2.4	6.0	1.8	0.4	N/A
#22.0	B	T493B226(1)016(2)(3)(4)(5)	3.5	6.0	2.2	0.8	N/A
22.0	C	T493C226(1)016(2)(3)(4)(5)	3.6	6.0	1.6	0.4	N/A
22.0	D	T493D226(1)016(2)(3)(4)(5)	3.6	6.0	0.8	0.3	N/A

- (1) To complete KEMET part number, insert M for ±20% or K for ±10% capacitance tolerance. To request ±5% tolerance, contact KEMET sales representative.
- (2) To complete KEMET part number, insert A for Non-ER; B for 0.1%/1000 Hrs.; or C for 0.01%/1000 Hrs. Reliability Level.
- (3) To complete KEMET part number, insert B for Gold Plated (50 μ inch minimum); C for Hot Solder Dipped (60 μ inch minimum); H for Solder Plated (100 μ inch minimum); K for Solder Fused (60 μ inch minimum Termination Finish or T for 100% Tin.
- (4) To complete KEMET part number for Surge Current testing, insert 61 for none; 62 for 10 cycles +25°C; or 64 for 10 cycles, -55°C & +85°C.
- (5) To complete KEMET part number, insert 10 for Standard ESR; 20 for Low ESR or 30 for Ultra-low ESR Option.

* Extended Values #Maximum Capacitance Change @ 125°C = +15%

SOLID TANTALUM CHIP CAPACITORS

T493 SERIES—Military COTS



T493 RATINGS AND PART NUMBER REFERENCE

Capacitance µF	Case Size	KEMET Part Number	DCL µA @ 25°C Max	DF % @ +25°C 120 Hz Max	Std. ESR Ohms @+25°C 100 kHz Max	Low ESR Ohms @+25°C 100 kHz Max	Ultra-Low ESR, Ohms @+25°C 100 kHz Max
16 Volt Rating at +85°C (10 Volt Rating at +125°C) cont.							
33.0	C	T493C336(1)016(2)(3)(4)(5)	5.3	6.0	1.2	0.3	0.23
33.0	D	T493D336(1)016(2)(3)(4)(5)	5.3	6.0	0.8	0.25	0.15
#47.0	C	T493C476(1)016(2)(3)(4)(5)	7.5	6.0	1.2	0.5	0.35
47.0	D	T493D476(1)016(2)(3)(4)(5)	7.5	6.0	0.8	0.2	0.10
68.0	D	T493D686(1)016(2)(3)(4)(5)	10.9	6.0	0.7	0.2	0.15
#100.0	D	T493D107(1)016(2)(3)(4)(5)	16.0	8.0	0.7	0.125	0.10
100.0	X	T493X107(1)016(2)(3)(4)(5)	16.0	8.0	0.7	0.1	0.08
#150.0	X	T493X157(1)016(2)(3)(4)(5)	24.0	8.0	0.5	0.2	0.10
20 Volt Rating at +85°C (13 Volt Rating at +125°C)							
0.47	A	T493A474(1)020(2)(3)(4)(5)	0.5	4.0	14.0	9.0	N/A
0.68	A	T493A684(1)020(2)(3)(4)(5)	0.5	4.0	12.0	8.0	N/A
1.0	A	T493A105(1)020(2)(3)(4)(5)	0.5	4.0	10.0	5.5	N/A
1.5	A	T493A155(1)020(2)(3)(4)(5)	0.5	6.0	8.0	4.5	N/A
1.5	B	T493B155(1)020(2)(3)(4)(5)	0.5	6.0	6.0	4.0	N/A
2.2	A	T493A225(1)020(2)(3)(4)(5)	0.5	6.0	7.0	4.0	N/A
2.2	B	T493B225(1)020(2)(3)(4)(5)	0.5	6.0	3.5	1.5	N/A
#3.3	A	T493A335(1)020(2)(3)(4)(5)	0.7	6.0	7.0	4.0	N/A
3.3	B	T493B335(1)020(2)(3)(4)(5)	0.7	6.0	3.5	1.3	N/A
#4.7	A	T493A475(1)020(2)(3)(4)(5)	1.0	8.0	6.0	1.8	N/A
4.7	B	T493B475(1)020(2)(3)(4)(5)	1.0	6.0	3.5	1.0	N/A
4.7	C	T493C475(1)020(2)(3)(4)(5)	1.0	6.0	2.4	0.6	N/A
#6.8	B	T493B685(1)020(2)(3)(4)(5)	1.4	6.0	3.5	1.0	N/A
6.8	C	T493C685(1)020(2)(3)(4)(5)	1.4	6.0	1.9	0.6	N/A
#10.0	B	T493B106(1)020(2)(3)(4)(5)	2.0	6.0	3.0	1.0	1.0
10.0	C	T493C106(1)020(2)(3)(4)(5)	2.0	6.0	1.8	0.5	0.48
15.0	C	T493C156(1)020(2)(3)(4)(5)	3.0	6.0	1.7	0.4	0.38
15.0	D	T493D156(1)020(2)(3)(4)(5)	3.0	6.0	1.0	0.35	0.28
#22.0	C	T493C226(1)020(2)(3)(4)(5)	4.4	6.0	1.2	0.4	N/A
22.0	D	T493D226(1)020(2)(3)(4)(5)	4.4	6.0	0.8	0.3	0.18
33.0	D	T493D336(1)020(2)(3)(4)(5)	6.6	6.0	0.8	0.2	0.15
47.0	D	T493D476(1)020(2)(3)(4)(5)	9.4	6.0	0.7	0.2	0.10
47.0	X	T493X476(1)020(2)(3)(4)(5)	7.5	4.0	0.7	0.15	0.10
#68.0	D	T493D686(1)020(2)(3)(4)(5)	13.6	8.0	0.7	0.2	0.15
68.0	X	T493X686(1)020(2)(3)(4)(5)	13.6	6.0	0.7	0.15	0.12
25 Volt Rating at +85°C (17 Volt Rating at +125°C)							
0.33	A	T493A334(1)025(2)(3)(4)(5)	0.5	4.0	15.0	10.0	N/A
0.47	A	T493A474(1)025(2)(3)(4)(5)	0.5	4.0	14.0	9.0	N/A
0.68	A	T493A684(1)025(2)(3)(4)(5)	0.5	4.0	10.0	6.0	N/A
0.68	B	T493B684(1)025(2)(3)(4)(5)	0.5	4.0	7.5	5.5	N/A
1.0	A	T493A105(1)025(2)(3)(4)(5)	0.5	4.0	8.0	4.0	N/A
1.0	B	T493B105(1)025(2)(3)(4)(5)	0.5	4.0	5.0	2.0	N/A
1.5	A	T493A155(1)025(2)(3)(4)(5)	0.5	6.0	10.0	3.0	N/A
1.5	B	T493B155(1)025(2)(3)(4)(5)	0.5	6.0	5.0	1.5	N/A
2.2	B	T493B225(1)025(2)(3)(4)(5)	0.6	6.0	4.5	1.2	N/A
2.2	C	T493C225(1)025(2)(3)(4)(5)	0.6	6.0	3.5	2.2	1.30
3.3	B	T493B335(1)025(2)(3)(4)(5)	0.9	6.0	3.5	2.0	N/A
3.3	C	T493C335(1)025(2)(3)(4)(5)	0.9	6.0	2.5	1.2	0.75
#4.7	B	T493B475(1)025(2)(3)(4)(5)	1.2	6.0	1.5	1.0	N/A
4.7	C	T493C475(1)025(2)(3)(4)(5)	1.2	6.0	2.4	0.6	0.58
6.8	C	T493C685(1)025(2)(3)(4)(5)	1.7	6.0	1.9	0.6	0.49
6.8	D	T493D685(1)025(2)(3)(4)(5)	1.7	6.0	1.4	1.0	N/A
10.0	C	T493C106(1)025(2)(3)(4)(5)	2.5	6.0	1.5	0.5	0.45
10.0	D	T493D106(1)025(2)(3)(4)(5)	2.5	6.0	1.0	0.4	N/A
#15.0	C	T493C156(1)025(2)(3)(4)(5)	3.8	6.0	1.5	0.9	N/A
15.0	D	T493D156(1)025(2)(3)(4)(5)	3.8	6.0	1.0	0.35	0.28
15.0	X	T493X156(1)025(2)(3)(4)(5)	3.0	6.0	0.7	0.2	0.20
22.0	D	T493D226(1)025(2)(3)(4)(5)	5.5	6.0	0.8	0.2	0.20
22.0	X	T493X226(1)025(2)(3)(4)(5)	4.4	4.0	0.7	0.23	0.23
33.0	D	T493D336(1)025(2)(3)(4)(5)	8.3	6.0	0.7	0.4	0.09
33.0	X	T493X336(1)025(2)(3)(4)(5)	8.3	6.0	0.7	0.3	0.18
†47.0	D	T493D476(1)025(2)(3)(4)(5)	11.8	10.0	0.7	0.2	0.12
†47.0	X	T493X476(1)025(2)(3)(4)(5)	11.8	6.0	0.7	0.3	0.15

- (1) To complete KEMET part number, insert M for ±20% or K for ±10% capacitance tolerance. To request ±5% tolerance, contact KEMET sales representative.
 - (2) To complete KEMET part number, insert A for Non-ER; B for 0.1%/1000 Hrs.; or C for 0.01%/1000 Hrs. Reliability Level.
 - (3) To complete KEMET part number, insert B for Gold Plated (50 µ inch minimum); C for Hot Solder Dipped (60 µ inch minimum); H for Solder Plated (100 µ inch minimum); K for Solder Fused (60 µ inch minimum Termination Finish or T for 100% Tin.
 - (4) To complete KEMET part number for Surge Current testing, insert 61 for none; 62 for 10 cycles +25°C; or 64 for 10 cycles, -55°C & +85°C.
 - (5) To complete KEMET part number, insert 10 for Standard ESR; 20 for Low ESR or 30 for Ultra-low ESR Option.
- * Extended Values #Maximum Capacitance Change @ 125°C = +15% † Maximum Capacitance Change @ 125°C = +20%



SOLID TANTALUM CHIP CAPACITORS

T493 SERIES—Military COTS

T493 RATINGS AND PART NUMBER REFERENCE

Capacitance µF	Case Size	KEMET Part Number	DCL µA @ 25°C Max	DF % @ +25°C 120 Hz Max	Std. ESR Ohms @+25°C 100 kHz Max	Low ESR Ohms @+25°C 100 kHz Max	Ultra-Low ESR, Ohms @+25°C 100 kHz Max
35 Volt Rating at +85°C (23 Volt Rating at +125°C)							
0.10	A	T493A104(1)035(2)(3)(4)(5)	0.5	4.0	20.0	10.0	N/A
0.15	A	T493A154(1)035(2)(3)(4)(5)	0.5	4.0	19.0	6.0	N/A
0.22	A	T493A224(1)035(2)(3)(4)(5)	0.5	4.0	18.0	6.0	N/A
0.33	A	T493A334(1)035(2)(3)(4)(5)	0.5	4.0	15.0	6.0	N/A
0.47	A	T493A474(1)035(2)(3)(4)(5)	0.5	4.0	14.0	4.0	N/A
0.47	B	T493B474(1)035(2)(3)(4)(5)	0.5	4.0	8.0	2.5	1.5
0.68	A	T493A684(1)035(2)(3)(4)(5)	0.5	4.0	10.0	6.0	N/A
0.68	B	T493B684(1)035(2)(3)(4)(5)	0.5	4.0	6.5	2.5	N/A
1.0	A	T493A105(1)035(2)(3)(4)(5)	0.5	4.0	10.0	6.0	N/A
1.0	B	T493B105(1)035(2)(3)(4)(5)	0.5	4.0	5.0	2.0	1.5
1.5	B	T493B155(1)035(2)(3)(4)(5)	0.5	6.0	5.0	3.0	N/A
1.5	C	T493C155(1)035(2)(3)(4)(5)	0.5	6.0	4.5	2.5	N/A
2.2	B	T493B225(1)035(2)(3)(4)(5)	0.8	6.0	4.0	2.5	1.5
2.2	C	T493C225(1)035(2)(3)(4)(5)	0.8	6.0	3.5	1.5	0.75
#3.3	B	T493B335(1)035(2)(3)(4)(5)	1.2	6.0	3.5	1.3	N/A
3.3	C	T493C335(1)035(2)(3)(4)(5)	1.2	6.0	2.5	0.8	0.60
4.7	C	T493C475(1)035(2)(3)(4)(5)	1.7	6.0	2.5	0.6	0.45
4.7	D	T493D475(1)035(2)(3)(4)(5)	1.7	6.0	1.5	0.7	N/A
6.8	C	T493C685(1)035(2)(3)(4)(5)	2.4	6.0	2.0	0.9	N/A
6.8	D	T493D685(1)035(2)(3)(4)(5)	2.4	6.0	1.3	0.5	0.40
#10.0	C	T493C106(1)035(2)(3)(4)(5)	3.5	6.0	2.0	1.2	N/A
10.0	D	T493D106(1)035(2)(3)(4)(5)	3.5	6.0	1.0	0.3	0.25
10.0	X	T493X106(1)035(2)(3)(4)(5)	2.8	4.0	0.9	0.25	0.18
15.0	D	T493D156(1)035(2)(3)(4)(5)	5.3	6.0	0.8	0.3	0.23
15.0	X	T493X156(1)035(2)(3)(4)(5)	5.3	6.0	0.9	0.3	0.20
#22.0	D	T493D226(1)035(2)(3)(4)(5)	7.7	6.0	0.7	0.4	0.20
22.0	X	T493X226(1)035(2)(3)(4)(5)	7.7	6.0	0.7	0.3	0.20
#33.0	X	T493X336(1)035(2)(3)(4)(5)	11.6	6.0	0.6	0.3	0.18
#47.0	E	T493E476(1)035(2)(3)(4)(5)	16.5	10.0	0.5	0.3	N/A
50 Volt Rating at +85°C (33 Volt Rating at +125°C)							
0.10	A	T493A104(1)050(2)(3)(4)(5)	0.5	4.0	20.0	10.0	N/A
0.15	A	T493A154(1)050(2)(3)(4)(5)	0.5	4.0	19.0	10.0	N/A
0.15	B	T493B154(1)050(2)(3)(4)(5)	0.5	4.0	16.0	10.0	N/A
0.22	B	T493B224(1)050(2)(3)(4)(5)	0.5	4.0	14.0	10.0	N/A
0.33	B	T493B334(1)050(2)(3)(4)(5)	0.5	4.0	10.0	2.5	N/A
0.47	B	T493B474(1)050(2)(3)(4)(5)	0.5	4.0	9.0	2.0	N/A
0.47	C	T493C474(1)050(2)(3)(4)(5)	0.5	4.0	8.0	1.8	N/A
0.68	C	T493C684(1)050(2)(3)(4)(5)	0.5	4.0	7.0	1.6	N/A
1.0	C	T493C105(1)050(2)(3)(4)(5)	0.5	4.0	5.5	1.6	1.3
1.5	C	T493C155(1)050(2)(3)(4)(5)	0.8	6.0	4.5	1.5	N/A
1.5	D	T493D155(1)050(2)(3)(4)(5)	0.8	6.0	3.5	1.0	N/A
2.2	C	T493C225(1)050(2)(3)(4)(5)	1.1	6.0	3.5	1.5	N/A
2.2	D	T493D225(1)050(2)(3)(4)(5)	1.1	6.0	2.5	0.8	0.60
3.3	D	T493D335(1)050(2)(3)(4)(5)	1.7	6.0	2.0	0.8	0.70
4.7	D	T493D475(1)050(2)(3)(4)(5)	2.4	6.0	1.5	0.6	0.28
4.7	X	T493X475(1)050(2)(3)(4)(5)	1.9	4.0	0.9	0.3	0.30
6.8	X	T493X685(1)050(2)(3)(4)(5)	3.5	6.0	1.0	0.5	N/A

- (1) To complete KEMET part number, insert M for ±20% or K for ±10% capacitance tolerance. To request ±5% tolerance, contact KEMET sales representative.
- (2) To complete KEMET part number, insert A for Non-ER; B for 0.1%/1000 Hrs.; or C for 0.01%/1000 Hrs. Reliability Level.
- (3) To complete KEMET part number, insert B for Gold Plated (50 µ inch minimum); C for Hot Solder Dipped (60 µ inch minimum); H for Solder Plated (100 µ inch minimum); K for Solder Fused (60 µ inch minimum Termination Finish or T for 100% Tin.
- (4) To complete KEMET part number for Surge Current testing, insert 61 for none; 62 for 10 cycles +25°C; or 64 for 10 cycles, -55°C & +85°C.
- (5) To complete KEMET part number, insert 10 for Standard ESR; 20 for Low ESR or 30 for Ultra-low ESR Option.

* Extended Values #Maximum Capacitance Change @ 125°C = +15%

SOLID TANTALUM CHIP CAPACITORS



T494 SERIES — Low ESR, Industrial Grade

FEATURES

- Low ESR values in EIA 535BAAC sizes
- Taped and Reeled per EIA 481-1
- Symmetrical, Compliant Terminations
- Optional Gold-plated Terminations
- Laser-marked Case
- 100% Surge Current test on C, D, E, U, V, X sizes
- Capacitance: 0.1 μ F to 1000 μ F
- Tolerance: $\pm 10\%$, $\pm 20\%$
- Voltage: 3-50 VDC
- Extended Range Values
- Low Profile Case Sizes
- RoHS Compliant & Leadfree Terminations (See www.kemet.com for lead transition)
- Operating Temperature: -55°C to $+125^{\circ}\text{C}$

CAPACITOR OUTLINE DRAWING

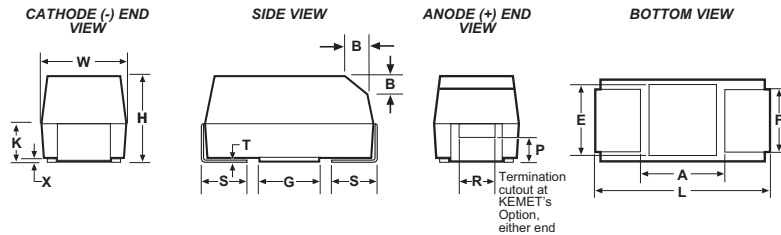

STANDARD T494 DIMENSIONS Millimeters (inches)

CASE SIZE		COMPONENT														
KEMET	EIA	L*	W*	H*	K* ± 0.20 $\pm (.008)$	F* ± 0.1 $\pm (.004)$	S* ± 0.3 $\pm (.012)$	B ± 0.15 $(\text{Ref}) \pm (.006)$	X (Ref)	P (Ref)	R (Ref)	T (Ref)	A (Min)	G (Ref)	E (Ref)	
A	3216-18	3.2 ± 0.2 (.126 $\pm .008$)	1.6 ± 0.2 (.063 $\pm .008$)	1.6 ± 0.2 (.063 $\pm .008$)	0.9 (.035)	1.2 (.047)	0.8 (.031)	0.4 (.016)	0.10 ± 0.10 (.004 $\pm .004$)	0.4 (.016)	0.4 (.016)	0.13 (.005)	1.4 (.055)	1.1 (.043)	1.3 (.051)	
B	3528-21	3.5 ± 0.2 (.138 $\pm .008$)	2.8 ± 0.2 (.110 $\pm .008$)	1.9 ± 0.2 (.075 $\pm .008$)	1.1 (.043)	2.2 (.087)	0.8 (.031)	0.4 (.016)	0.10 ± 0.10 (.004 $\pm .004$)	0.5 (.020)	1.0 (.039)	0.13 (.005)	2.1 (.083)	1.8 (.071)	2.2 (.087)	
C	6032-28	6.0 ± 0.3 (.236 $\pm .012$)	3.2 ± 0.3 (.126 $\pm .012$)	2.5 ± 0.3 (.098 $\pm .012$)	1.4 (.055)	2.2 (.087)	1.3 (.051)	0.5 (.020)	0.10 ± 0.10 (.004 $\pm .004$)	0.9 (.035)	1.0 (.039)	0.13 (.005)	3.1 (.122)	2.8 (.110)	2.4 (.094)	
D	7343-31	7.3 ± 0.3 (.287 $\pm .012$)	4.3 ± 0.3 (.169 $\pm .012$)	2.8 ± 0.3 (.110 $\pm .012$)	1.5 (.059)	2.4 (.094)	1.3 (.051)	0.5 (.020)	0.10 ± 0.10 (.004 $\pm .004$)	0.9 (.035)	1.0 (.039)	0.13 (.005)	3.8 (.150)	3.5 (.138)	3.5 (.138)	
X	7343-43	7.3 ± 0.3 (.287 $\pm .012$)	4.3 ± 0.3 (.169 $\pm .012$)	4.0 ± 0.3 (.157 $\pm .012$)	2.3 (.091)	2.4 (.094)	1.3 (.051)	0.5 (.020)	0.10 ± 0.10 (.004 $\pm .004$)	1.7 (.067)	1.0 (.039)	0.13 (.005)	3.8 (.150)	3.5 (.138)	3.5 (.138)	
E	7260-38	7.3 ± 0.3 (.287 $\pm .012$)	6.0 ± 0.3 (.236 $\pm .012$)	3.6 ± 0.2 (.142 $\pm .008$)	2.3 (.091)	4.1 (.161)	1.3 (.051)	0.5 (.020)	0.10 ± 0.10 (.004 $\pm .004$)	0.9 (.035)	1.0 (.039)	0.13 (.005)	3.8 (.150)	3.5 (.138)	3.5 (.138)	

Notes: 1. Metric dimensions govern.
2. (Ref) - Dimensions provided for reference only.
* Mil-C-55365/8 Specified Dimensions

LOW PROFILE T494 DIMENSIONS Millimeters (inches)

CASE SIZE		COMPONENT										
KEMET	EIA	L	W	H Max.	K Min.	F ± 0.1	S ± 0.3	X (Ref)	T (Ref)	A (Min)	G (Ref)	E (Ref)
R	2012-12	2.0 ± 0.2 (.079 $\pm .008$)	1.3 ± 0.2 (.051 $\pm .008$)	1.2 (.047)	0.3 (.012)	0.9 (.035)	0.5 (.020)	0.05 (.002)	0.13 (.005)	0.8 (.031)	0.5 (.020)	0.8 (.031)
S	3216-12	3.2 ± 0.2 (.126 $\pm .008$)	1.6 ± 0.2 (.063 $\pm .008$)	1.2 (.047)	0.3 (.012)	1.2 (.047)	0.8 (.031)	0.05 (.002)	0.13 (.005)	1.4 (.055)	1.1 (.043)	1.3 (.051)
T	3528-12	3.5 ± 0.2 (.138 $\pm .008$)	2.8 ± 0.2 (.110 $\pm .008$)	1.2 (.047)	0.3 (.012)	2.2 (.087)	0.8 (.031)	0.05 (.002)	0.13 (.005)	2.1 (.083)	1.8 (.071)	2.2 (.087)
U	6032-15	6.0 ± 0.3 (.236 $\pm .012$)	3.2 ± 0.3 (.126 $\pm .012$)	1.5 (.059)	0.5 (.020)	2.2 (.087)	1.3 (.051)	0.05 (.002)	0.13 (.005)	3.1 (.122)	2.8 (.110)	2.4 (.094)
V	7343-20	7.3 ± 0.3 (.287 $\pm .012$)	4.3 ± 0.3 (.169 $\pm .012$)	2.0 (.079)	0.9 (.035)	2.4 (.094)	1.3 (.051)	0.05 (.002)	0.13 (.005)	3.8 (.150)	3.5 (.138)	3.5 (.138)

Notes: 1. Metric dimensions govern.
2. (Ref) - Dimensions provided for reference only.
3. No dimensions provided for B, P or R because low profile cases do not have a bevel or a notch.

T494 ORDERING INFORMATION

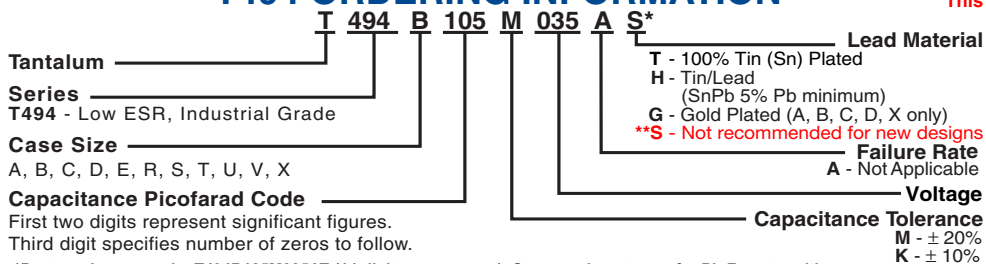

*Part number example: T494B105M035AT (14 digits - no spaces). See www.kemet.com for Pb Free transition.
** "S" Termination codes are converting from 90Sn/10 Pb to 100% tin finishes. Orders including "S" suffix termination codes do not guarantee Pb-free product.

T494 RATINGS & PART NUMBER REFERENCE

Capacitance µF	Case Size	KEMET Part Number	DC Leakage µA @ 25°C Max	DF % @ +25°C 120 Hz Max	ESR Ω @ +25°C 100 kHz Max
35 Volt Rating at +85°C (23 Volt Rating at +125°C)					
0.10	A	T494A104(1)035A(2)	0.5	4.0	10.0
0.15	A	T494A154(1)035A(2)	0.5	4.0	6.0
0.22	A	T494A224(1)035A(2)	0.5	4.0	6.0
0.33	A	T494A334(1)035A(2)	0.5	4.0	6.0
0.47	B	T494B474(1)035A(2)	0.5	4.0	2.5
0.47	A	T494A474(1)035A(2)	0.5	4.0	4.0
0.68	B	T494B684(1)035A(2)	0.5	4.0	2.5
0.68	A	T494A684(1)035A(2)	0.5	4.0	6.0
1.0	B	T494B105(1)035A(2)	0.5	4.0	2.0
1.0	A	T494A105(1)035A(2)	0.5	4.0	6.0
1.5	C	T494C155(1)035A(2)	0.5	6.0	2.5
1.5	B	T494B155(1)035A(2)	0.5	6.0	3.0
2.2	C	T494C225(1)035A(2)	0.8	6.0	1.5
2.2	B	T494B225(1)035A(2)	0.8	6.0	2.5
3.3	C	T494C335(1)035A(2)	1.2	6.0	0.8
#3.3	B	T494B335(1)035A(2)	1.2	6.0	1.3
4.7	D	T494D475(1)035A(2)	1.7	6.0	0.7
4.7	C	T494C475(1)035A(2)	1.7	6.0	0.7
6.8	D	T494D685(1)035A(2)	2.4	6.0	0.5
6.8	C	T494C685(1)035A(2)	2.4	6.0	0.9
10.0	D	T494D106(1)035A(2)	3.5	6.0	0.4
#10.0	C	T494C106M035A(2)	3.5	6.0	1.2
#10.0	*V	T494V106(1)035A(2)	3.5	6.0	0.8
15.0	X	T494X156(1)035A(2)	5.3	6.0	0.30
15.0	D	T494D156(1)035A(2)	5.3	6.0	0.35
#22.0	X	T494X226(1)035A(2)	7.7	6.0	0.3
#22.0	D	T494D226(1)035A(2)	7.7	6.0	0.4
#33.0	D	T494D336(1)035A(2)	11.6	6.0	0.6
#33.0	X	T494X336(1)035A(2)	11.6	6.0	0.6
†47.0	X	T494X476(1)035A(2)	16.5	8.0	0.5
†47.0	E	T494E476(1)035A(2)	16.5	10.0	0.3
50 Volt Rating at +85°C (33 Volt Rating at +125°C)					
0.10	A	T494A104(1)050A(2)	0.5	4.0	10.0
0.15	B	T494B154(1)050A(2)	0.5	4.0	10.0
0.15	A	T494A154(1)050A(2)	0.5	4.0	10.0
0.22	B	T494B224(1)050A(2)	0.5	4.0	10.0
0.33	B	T494B334(1)050A(2)	0.5	4.0	2.5
0.47	C	T494C474(1)050A(2)	0.5	4.0	1.8
0.47	B	T494B474(1)050A(2)	0.5	4.0	2.0
0.68	C	T494C684(1)050A(2)	0.5	4.0	1.6
0.68	B	T494B684(1)050A(2)	0.5	4.0	3.0
1.0	C	T494C105(1)050A(2)	0.5	4.0	1.6
#1.0	V	T494V105M050A(2)	0.5	4.0	4.0
1.5	D	T494D155(1)050A(2)	0.8	6.0	1.0
1.5	C	T494C155(1)050A(2)	0.8	6.0	1.5
2.2	D	T494D225(1)050A(2)	1.1	6.0	0.8
2.2	C	T494C225(1)050A(2)	1.1	6.0	1.5
3.3	D	T494D335(1)050A(2)	1.7	6.0	0.8
4.7	D	T494D475(1)050A(2)	2.4	6.0	0.6
6.8	X	T494X685(1)050A(2)	3.5	6.0	0.5
#6.8	D	T494D685(1)050A(2)	3.4	6.0	0.7
#10.0	X	T494X106M050A(2)	5.0	6.0	0.4
#10.0	D	T494D106(1)050A(2)	5.0	6.0	0.7
†15.0	X	T494X156(1)050A(2)	7.5	6.0	0.4

CAPACITOR MARKINGS
T494 Series — All Case Sizes

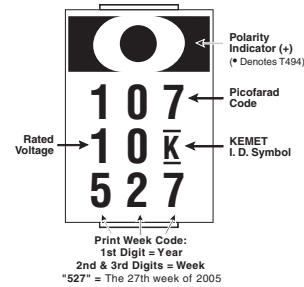

CONSTRUCTION

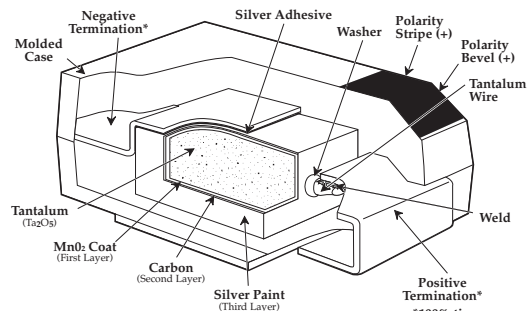

(1) To complete KEMET Part Number, insert M for ±20% tolerance or K for ±10% tolerance.
 (2) To complete KEMET Part Number, insert S, H, G, or T lead material designation as shown on page 27.
 *Extended Values
 **6 Volt product equivalent to 6.3 volt product.
 #Maximum Capacitance Change @ 125°C=+15%.
 †Maximum Capacitance Change @ 125°C=+20%.

Higher voltage ratings and tighter tolerance product may be substituted within the same size at KEMET's option.
 Voltage substitutions will be marked with the higher voltage rating.

SOLID TANTALUM CHIP CAPACITORS

T495 SERIES—Low ESR, Surge Robust



FEATURES

- Designed for very low ESR
- High ripple current capability
- High surge current capability
- 100% accelerated steady-state aging
- 100% Surge Current test
- Meets or Exceeds EIA Standard 535BAAC
- Available tested per DSCC Dwg. 95158
- Operating Temperature: -55°C to +125°C
- New Extended Values for Low ESR
- Low Equivalent Series Inductance (<2.5nH ESL)
- Precision-molded, laser-marked case
- Symmetrical, compliant terminations
- Taped and reeled per EIA 481-1
- RoHS Compliant & Leadfree Terminations (see www.kemet.com for lead transition)

OUTLINE DRAWING

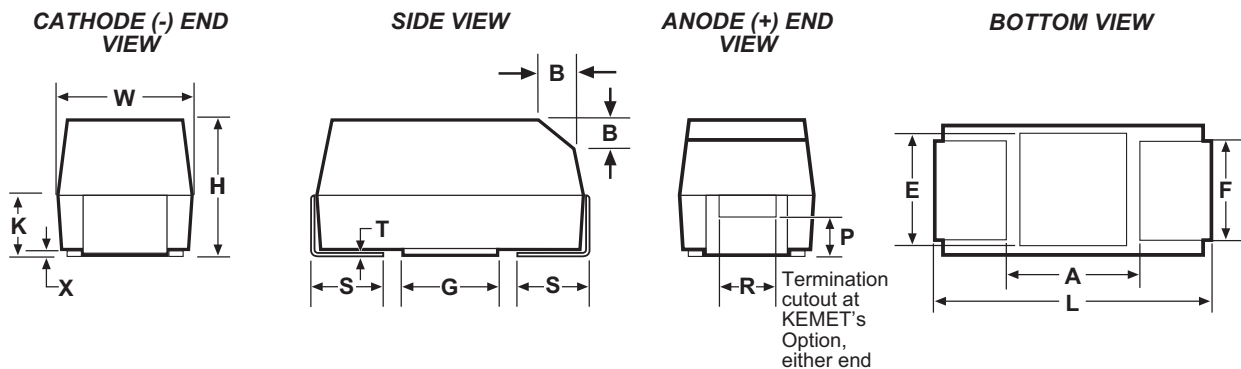

STANDARD T495 DIMENSIONS

Millimeters (Inches)

Case Size		L	W	H	K ±0.20	F ±0.1	S ±0.3	B ±0.15 (Ref) ±(.006)	X (Ref)	P (Ref)	R (Ref)	T (Ref)	A (Min)	G (Ref)	E (Ref)
KEMET	EIA														
A	3216-18	3.2 ± 0.2 (.126 ± .008)	1.6 ± 0.2 (.063 ± .008)	1.6 ± 0.2 (.063 ± .008)	0.9 (.035)	1.2 (.047)	0.8 (.031)	0.4 (.016)	0.10 ± 0.10 (.004 ± .004)	0.4 (.016)	0.4 (.016)	0.13 (.005)	1.4 (.055)	1.1 (.043)	1.3 (.051)
B	3528-21	3.5 ± 0.2 (.138 ± .008)	2.8 ± 0.2 (.110 ± .008)	1.9 ± 0.1 (.075 ± .008)	1.1 (.043)	2.2 (.087)	0.8 (.031)	0.4 (.016)	0.10 ± 0.10 (.004 ± .004)	0.5 (.020)	1.0 (.039)	0.13 (.005)	2.1 (.083)	1.8 (.071)	2.2 (.087)
C	6032-28	6.0 ± 0.3 (.236 ± .012)	3.2 ± 0.3 (.126 ± .12)	2.5 ± 0.3 (.098 ± .012)	1.4 (.055)	2.2 (.087)	1.3 (.051)	0.5 (.020)	0.10 ± 0.10 (.004 ± .004)	0.9 (.0235)	1.0 (.039)	0.13 (.005)	3.1 (.122)	2.8 (.110)	2.4 (.094)
D	7343-31	7.3 ± 0.3 (.287 ± .012)	4.3 ± 0.3 (.169 ± .012)	2.8 ± 0.3 (.110 ± .012)	1.5 (.059)	2.4 (.094)	1.3 (.051)	0.5 (.020)	0.10 ± 0.10 (.004 ± .004)	0.9 (.0235)	1.0 (.039)	0.13 (.005)	3.8 (.150)	3.5 (.138)	3.5 (.138)
X	7343-43	7.3 ± 0.3 (.287 ± .012)	4.3 ± 0.3 (.169 ± .012)	4.0 ± 0.3 (.157 ± .012)	2.3 (.091)	2.4 (.094)	1.3 (.051)	0.5 (.020)	0.10 ± 0.10 (.004 ± .004)	1.7 (.067)	1.0 (.039)	0.13 (.005)	3.8 (.150)	3.5 (.138)	3.5 (.138)
E	7260-38	7.3 ± 0.3 (.287 ± .012)	6.0 ± 0.3 (.236 ± .012)	3.6 ± 0.2 (.142 ± .008)	2.3 (.091)	4.1 (.161)	1.3 (.051)	0.5 (.020)	0.10 ± 0.10 (.004 ± .004)	0.9 (.035)	1.0 (.039)	0.13 (.005)	3.8 (.150)	3.5 (.138)	3.5 (.138)

Notes: 1. Metric dimensions govern.
2. (Ref) - Dimensions provided for reference only.

LOW PROFILE T495 DIMENSIONS

Millimeters (Inches)

CASE SIZE		COMPONENT										
KEMET	EIA	L	W	H Max.	K Min.	F ± 0.1	S ± 0.3	X (Ref)	T (Ref)	A (Min)	G (Ref)	E (Ref)
T	3528-12	3.5 ± 0.2 (.138 ± .008)	2.8 ± 0.2 (.110 ± .008)	1.2 (.047)	0.3 (.012)	2.2 (.087)	0.8 (.031)	0.05 (.002)	0.13 (.005)	2.1 (.083)	1.8 (.071)	2.2 (.087)
V	7343-20	7.3 ± 0.3 (.287 ± .012)	4.3 ± 0.3 (.169 ± .012)	2.0 (0.079)	0.9 (.035)	2.4 (.094)	1.3 (.051)	0.05 (.002)	0.13 (.005)	3.8 (.150)	3.5 (.138)	3.5 (.138)

Notes: 1. Metric dimensions govern.
2. (Ref) - Dimensions provided for reference only.
3. No dimensions provided for B, P or R because low profile cases do not have a bevel or a notch.

*Pb-free supply is not guaranteed with the 'S' termination code.
This termination code not available effective 15 July 2007.

T495 Series – ORDERING INFORMATION

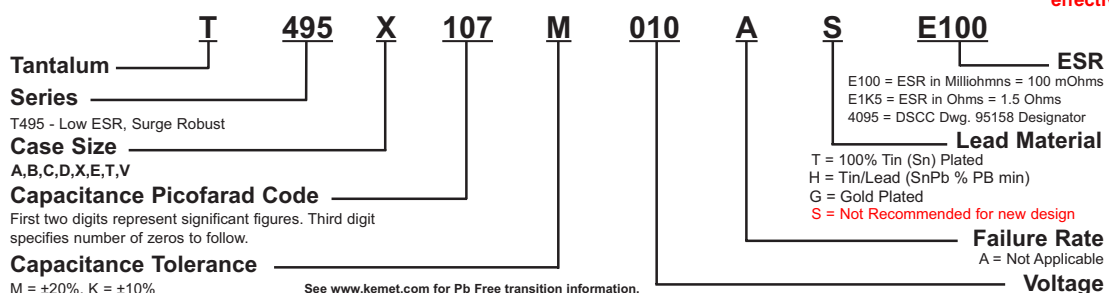

SOLID TANTALUM CHIP CAPACITORS

T495 SERIES—Low ESR, Surge Robust



T495 TANTALUM CHIP CAPACITANCE VALUES

Case Size and Max. ESR (mΩ) by Capacitance & Voltage
Standard Capacitance Values

Capacitance		Rated Voltage @ +85°C								
μF	Code	2.5	4	6	10	16	20	25	35	50
0.47	474							A,4500	B,1500 B,2200	
1.0	105						A,3000		A,3000 B,1500 B,1700	C,1300
2.2	225					A,1800		C,1300	B,1500 C,750	D,600
3.3	335					A,3000		C,750	B,900 C,525,550,600	D,700
4.7	475				A,1300 B,1300	A,2000 B,700		C,575	B,1000 C,450,500 C,600	D,275,300 X,300
6.8	685				A,1800 B,900	C,750		B,1500 C,400,490,500	D,400 X,300	D,190,200,275 D,300
10.0	106				A,1800 B,750	A,1700 T,4000	B,1000 C,400,475	B,750 C,450	D,120,125,250 D,300 X,175,200 X,250	X,250,300
15.0	156				B,500 C,375,400,475	A,2500 B,800	C,375 D,275	D,275 X,200	C,350 D,225,300 X,200,225	X,300
22.0	226			A,900	B,500 C,290,345	B,600	D,180,225 D,275	C,300,900 D,200 X,225	D,125,200,250 D,300 X,125,200,275,300	
33.0	336				B,450 V,100,150	C,200,225,275 D,150,175,225,250	D,100,150 200	D,90,100 D,225,300 X,100,175	D,300 X,100,175,250	
47.0	476			B,450 C,250 V,150	B,500 D,80,90,200	C,350 D,100,150,200	D,75,100,175 X,65,100 X,125,150	D,120,250 X,80,150,185,200	X,185,200,300	
68.0	686		V,150	D,175	V,70,100,140 B,600,750 B,900 C,80,225 D,90,150 X,150	V,180,300 D,150	D,70,150 X,120,150	X,125,150 200		
100.0	107	T,3000	B,500	V,90,150 B,400,700 C,75,150 D,150	C,100 V,100,150 D,50,65,80,100 X,100	D,100,125 X,80,100,125	X,150 E,85,100 200	E,100		
150.0	157		B,900 C,70,250	V,40,70 C,50,200 X,100,125	C,200 D,50,60,80,100 X,70,80,85,100 V,100,150	D,100,125,150 X,75,100	E,80			
220.0	227	D,45		C,225 D,45,100 X,70,100	V,150 D,45,75 D,100,125 X,45,50,60,70,100	X,100 E,50,100,150				
330.0	337		C,300,700 D,30,45	X,45,65, X,100 D,40,50,70, D,100 E,40,60,100	D,100,125 X,35,50,60 E,40,60,100					
470.0	477	D,35	D,45,100 X,30,45,100	X,30,45,50, X,65 D,45,100,125 E,40,55,100	X,45,50					
680.0	687									
1000.0	108	X,30,40	X,30,40,60,70 E,35,50	E,50						

Note that standard values are preferred, especially where high surge currents are possible. Extended values are available to increase capacitance and reduce ESR. Note that standard CV values demonstrate inherently lower failure rates than extended CV values, especially in low impedance applications.

SOLID TANTALUM CHIP CAPACITORS

T496 SERIES—Fail-Safe Fused

FEATURES

- Built-in fuse protects against damaging short circuit failure mode
- Precision-molded, laser-marked case
- Symmetrical, compliant terminations
- Taped and reeled per EIA 481-1
- Case geometry and footprints equivalent to Industrial Grade T491 Series. (Case sizes B, C, D and X only)
- 100% Surge Current test on C, D, X sizes
- Patented fuse assembly
- Operating Temperature: -55°C to +125°C
- Fuse actuation, 25°C: within 1 second at fault currents of 4 amps and higher.
- Continuous current capability: 0.75 amps
- Post-actuation resistance, 25°C: 10 megohms minimum
- Test tabs on the sides of the case bypass the capacitor element to allow direct testing of the fuse assembly.
- RoHS Compliant & Leadfree Terminations (See www.kemet.com for lead transition)

OUTLINE DRAWINGS

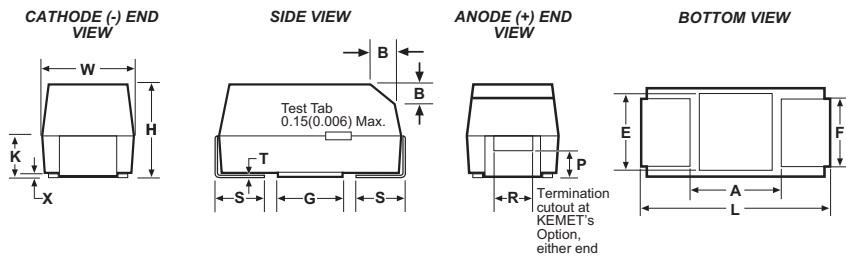

DIMENSIONS — Millimeters (Inches)

CASE SIZE		COMPONENT													
KEMET	EIA	L	W	H	K ±0.20 ±(.008)	F ±0.1 ±(.004)	S ±0.3 ±(.012)	B ±0.15 (Ref)±(.006)	X (Ref)	P (Ref)	R (Ref)	T (Ref)	A (Min)	G (Ref)	E (Ref)
B	3528-21	3.5 ± 0.2 (.138 ± .008)	2.8 ± 0.2 (.110 ± .008)	1.9 ± 0.2 (.075 ± .008)	1.1 (.043)	2.2 (.087)	0.8 (.031)	0.4 (.016)	0.10 ± 0.10 (.004 ± .004)	0.5 (.020)	1.0 (.039)	0.13 (.005)	2.1 (.083)	1.8 (.071)	2.2 (.087)
C	6032-28	6.0 ± 0.3 (.236 ± .012)	3.2 ± 0.3 (.126 ± .012)	2.5 ± 0.3 (.098 ± .012)	1.4 (.055)	2.2 (.087)	1.3 (.051)	0.5 (.020)	0.10 ± 0.10 (.004 ± .004)	0.9 (.035)	1.0 (.039)	0.13 (.005)	3.1 (.122)	2.8 (.110)	2.4 (.094)
D	7343-31	7.3 ± 0.3 (.287 ± .012)	4.3 ± 0.3 (.169 ± .012)	2.8 ± 0.3 (.110 ± .012)	1.5 (.059)	2.4 (.094)	1.3 (.051)	0.5 (.020)	0.10 ± 0.10 (.004 ± .004)	0.9 (.035)	1.0 (.039)	0.13 (.005)	3.8 (.150)	3.5 (.138)	3.5 (.138)
X	7343-43	7.3 ± 0.3 (.287 ± .012)	4.3 ± 0.3 (.169 ± .012)	4.0 ± 0.3 (.157 ± .012)	2.3 (.091)	2.4 (.094)	1.3 (.051)	0.5 (.020)	0.10 ± 0.10 (.004 ± .004)	1.7 (.067)	1.0 (.039)	0.13 (.005)	3.8 (.150)	3.5* (.138)	3.5* (.138)

Notes: 1. Metric dimensions govern.
2. (Ref) - Dimensions provided for reference only.
* Round glue pad: 2.9 ± 0.1mm (.114" ± .004") in diameter at KEMET's option.

T496 Series – ORDERING INFORMATION

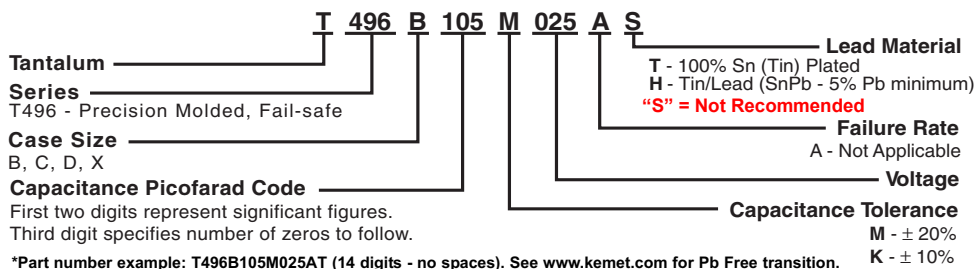

*Part number example: T496B105M025AT (14 digits - no spaces). See www.kemet.com for Pb Free transition.
** "S" Termination codes are converting from 90Sn/10 Pb to 100% tin finishes. Orders including "S" suffix termination codes do not guarantee Pb-free product.

*Pb-free supply is not guaranteed with the 'S' termination code.
This termination code not available effective 15 July 2007.

TYPICAL FUSE ACTUATION PROFILE

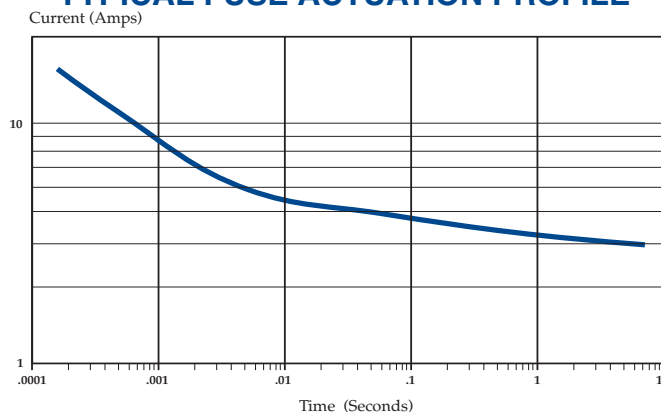

T496 RATINGS & PART NUMBER REFERENCE

Capacitance μ F	Case Size	KEMET Part Number	DCL μ A @ 25°C Max.	DF% @ +25°C 120 Hz. Max.	ESR Ω @ +25°C 100 kHz Max.
20 Volt Rating at +85°C (13 Volt Rating at +125°C)					
1.5	B	T496B155(1)020A(2) E5K0	0.5	6.0	5.0
2.2	B	T496B225(1)020A(2) E3K5	0.5	6.0	3.5
2.2	B	T496B225(1)020A(2) E1K6	0.5	6.0	1.6
3.3	B	T496B335(1)020A(2) E3K5	0.7	6.0	3.5
4.7	C	T496C475(1)020A(2) E2K0	1.0	6.0	2.0
6.8	C	T496C685(1)020A(2) E2K0	1.4	6.0	2.0
6.8	C	T496C685(1)020A(2) E600	1.4	6.0	0.6
10.0	C	T496C106(1)020A(2) E2K0	2.0	6.0	2.0
10.0	C	T496C106(1)020A(2) E800	2.0	6.0	0.8
15.0	D	T496D156(1)020A(2) E1K0	3.0	6.0	1.0
15.0	D	T496D156(1)020A(2) E500	3.0	6.0	0.5
15.0	C	T496C156(1)020A(2) E500	3.0	6.0	0.5
22.0	D	T496D226(1)020A(2) E1K0	4.4	6.0	1.0
22.0	D	T496D226(1)020A(2) E500	4.4	6.0	0.5
33.0	X	T496X336(1)020A(2) E900	6.6	6.0	0.9
33.0	X	T496X336(1)020A(2) E400	6.6	6.0	0.4
33.0	D	T496D336(1)020A(2) E400	6.6	6.0	0.4
47.0	X	T496X476(1)020A(2) E300	9.4	6.0	0.3
47.0	D	T496D476(1)020A(2) E300	9.4	6.0	0.3
25 Volt Rating at +85°C (17 Volt Rating at +125°C)					
0.68	B	T496B684(1)025A(2) E6K5	0.5	4.0	6.5
1.0	B	T496B105(1)025A(2) E5K0	0.5	4.0	5.0
1.0	B	T496B105(1)025A(2) E3K5	0.5	4.0	3.5
1.5	B	T496B155(1)025A(2) E5K0	0.5	6.0	5.0
1.5	B	T496B155(1)025A(2) E1K6	0.5	6.0	1.6
2.2	C	T496C225(1)025A(2) E3K5	0.6	6.0	3.5
3.3	C	T496C335(1)025A(2) E2K5	0.9	6.0	2.5
3.3	C	T496C335(1)025A(2) E2K1	0.9	6.0	2.1
4.7	C	T496C475(1)025A(2) E2K5	1.2	6.0	2.5
4.7	C	T496C475(1)025A(2) E1K3	1.2	6.0	1.3
6.8	C	T496C685(1)025A(2) E2K0	1.7	6.0	2.0
6.8	C	T496C685(1)025A(2) E600	1.7	6.0	0.6
10.0	C	T496C106(1)025A(2) E600	2.5	6.0	0.6
10.0	D	T496D106(1)025A(2) E1K2	2.5	6.0	1.2
10.0	D	T496D106(1)025A(2) E600	2.5	6.0	0.6
15.0	D	T496D156(1)025A(2) E1K0	3.8	6.0	1.0
15.0	D	T496D156(1)025A(2) E500	3.8	6.0	0.5
22.0	X	T496X226(1)025A(2) E900	5.5	6.0	0.9
22.0	X	T496X226(1)025A(2) E400	5.5	6.0	0.4
22.0	D	T496D226(1)025A(2) E800	5.5	6.0	0.8
22.0	D	T496D226(1)025A(2) E400	5.5	6.0	0.4

Capacitance μ F	Case Size	KEMET Part Number	DCL μ A @ 25°C Max.	DF% @ +25°C 120 Hz. Max.	ESR Ω @ +25°C 100 kHz Max.
35 Volt Rating at +85°C (23 Volt Rating at +125°C)					
0.47	B	T496B474(1)035A(2) E8K0	0.5	4.0	8.0
0.47	B	T496B474(1)035A(2) E2K6	0.5	4.0	2.6
0.68	B	T496B684(1)035A(2) E6K5	0.5	4.0	6.5
1.0	B	T496B105(1)035A(2) E5K0	0.5	4.0	5.0
1.0	B	T496B105(1)035A(2) E3K1	0.5	4.0	3.1
1.5	C	T496C155(1)035A(2) E4K5	0.5	6.0	4.5
1.5	C	T496C155(1)035A(2) E2K6	0.5	6.0	2.6
2.2	C	T496C225(1)035A(2) E3K5	0.8	6.0	3.5
2.2	C	T496C225(1)035A(2) E1K6	0.8	6.0	1.6
3.3	C	T496C335(1)035A(2) E2K5	1.2	6.0	2.5
3.3	C	T496C335(1)035A(2) E900	1.2	6.0	0.9
4.7	D	T496D475(1)035A(2) E1K5	1.7	6.0	1.5
4.7	D	T496D475(1)035A(2) E700	1.7	6.0	0.7
6.8	D	T496D685(1)035A(2) E1K3	2.4	6.0	1.3
6.8	D	T496D685(1)035A(2) E750	2.4	6.0	0.75
10.0	X	T496X106(1)035A(2) E1K0	3.5	6.0	1.0
10.0	X	T496X106(1)035A(2) E500	3.5	6.0	0.5
10.0	D	T496D106(1)035A(2) E400	3.5	6.0	0.5
15.0	X	T496X156(1)035A(2) E900	5.3	6.0	0.9
15.0	X	T496X156(1)035A(2) E500	5.3	6.0	0.5
15.0	D	T496D156(1)035A(2) E500	5.3	6.0	0.5
22.0	X	T496X226(1)035A(2) E300	7.7	6.0	0.3
50 Volt Rating at +85°C (33 Volt Rating at +125°C)					
0.15	B	T496B154(1)050A(2) E16K	0.5	4.0	16.0
0.22	B	T496B224(1)050A(2) E14K	0.5	4.0	14.0
0.22	B	T496B224(1)050A(2) E10K	0.5	4.0	10.0
0.33	B	T496B334(1)050A(2) E10K	0.5	4.0	10.0
0.33	B	T496B334(1)050A(2) E2K6	0.5	4.0	2.6
0.47	C	T496C474(1)050A(2) E8K0	0.5	4.0	8.0
0.47	C	T496C474(1)050A(2) E1K9	0.5	4.0	1.9
0.68	C	T496C684(1)050A(2) E7K0	0.5	4.0	7.0
0.68	C	T496C684(1)050A(2) E1K7	0.5	4.0	1.7
1.0	C	T496C105(1)050A(2) E5K5	0.5	4.0	5.5
1.0	C	T496C105(1)050A(2) E2K7	0.5	4.0	2.7
1.5	C	T496C155(1)050A(2) E5K0	0.8	6.0	5.0
1.5	C	T496C155(1)050A(2) E2K0	0.8	6.0	2.0
2.2	D	T496D225(1)050A(2) E2K5	1.1	6.0	2.5
2.2	D	T496D225(1)050A(2) E900	1.1	6.0	0.9
3.3	D	T496D335(1)050A(2) E2K0	1.7	6.0	2.0
3.3	D	T496D335(1)050A(2) E1K0	1.7	6.0	1.0
4.7	X	T496X475(1)050A(2) E1K5	2.4	6.0	1.5
4.7	X	T496X475(1)050A(2) E400	2.4	6.0	0.4
4.7	D	T496D475(1)050A(2) E400	2.4	6.0	0.4

(1) To complete KEMET Part Number, insert M for $\pm 20\%$ tolerance or K for $\pm 10\%$ tolerance.

(2) To complete KEMET Part Number, insert lead material designation for Ordering Information on page 36.

Higher voltage ratings and tighter capacitance tolerance product may be substituted within the same size at KEMET's option. Voltage substitutions will be marked with the higher voltage rating.

SOLID TANTALUM CHIP CAPACITORS

T498 SERIES—HIGH TEMPERATURE (150°)



Features

- 150°C Maximum temperature capability
- Temperature/Voltage derating: 2/3 at 150°C
- Self-healing mechanism
- Capacitance: 0.47 to 220µF
- Reliability: 0.5%/1000 Hrs. @ rated voltage @ rated temperature
- 100% Accelerated steady state aging
- 100% Surge current testing
- EIA standard case size
- Voltage: 6 to 50 VDC
- RoHS Compliant versions available
- Various termination options

Outline Drawings

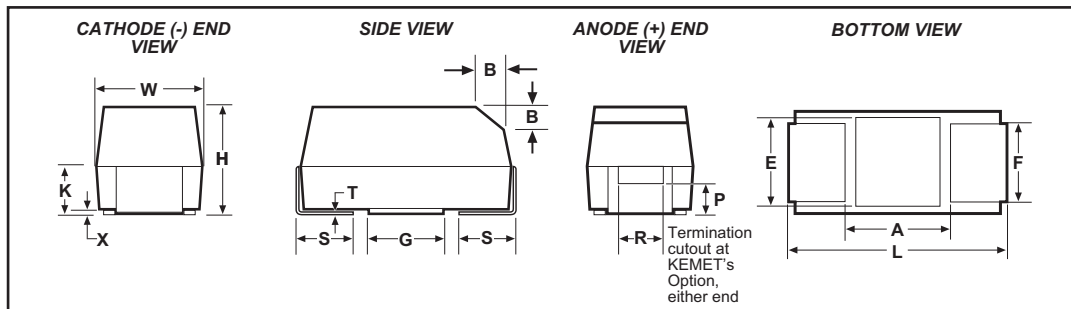

Dimensions - Millimeters (Inches)

Case Size		Component													
KEMET	EIA	L*	W*	H*	K* ± 0.20 ± (.008)	F* ± 0.1 ± (.004)	S* ± 0.3 ± (.012)	B (Ref) ± 0.15 ± (.004)	X (Ref)	P (Ref)	R (Ref)	T (Ref)	A (Min)	G (Ref)	E (Ref)
A	3216-18	3.2 ± 0.2 (.126 ± .008)	1.6 ± 0.2 (.063 ± .008)	1.6 ± 0.2 (.063 ± .008)	0.9 (.035)	1.2 (.047)	0.8 (.031)	0.4 (.016)	0.10 ± 0.10 (.004 ± .004)	0.4 (.016)	0.4 (.016)	0.13 (.005)	1.4 (.055)	1.1 (.043)	1.3 (.051)
B	3528-21	3.5 ± 0.2 (.138 ± .008)	2.8 ± 0.2 (.110 ± .008)	1.9 ± 0.2 (.075 ± .008)	1.1 (.043)	2.2 (.087)	0.8 (.031)	0.4 (.016)	0.10 ± 0.10 (.004 ± .004)	0.5 (.020)	1.0 (.039)	0.13 (.005)	2.1 (.083)	1.8 (.071)	2.2 (.087)
C	6032-28	6.0 ± 0.3 (.236 ± .012)	3.2 ± 0.3 (.126 ± .012)	2.5 ± 0.3 (.098 ± .012)	1.4 (.055)	2.2 (.087)	1.3 (.051)	0.5 (.020)	0.10 ± 0.10 (.004 ± .004)	0.9 (.035)	1.0 (.039)	0.13 (.005)	3.1 (.122)	2.8 (.110)	2.4 (.094)
D	7343-31	7.3 ± 0.3 (.287 ± .012)	4.3 ± 0.3 (.169 ± .012)	2.8 ± 0.3 (.110 ± .012)	1.5 (.059)	2.4 (.094)	1.3 (.051)	0.5 (.020)	0.10 ± 0.10 (.004 ± .004)	0.9 (.035)	1.0 (.039)	0.13 (.005)	3.8 (.150)	3.5 (.138)	3.5 (.138)
X	7343-43	7.3 ± 0.3 (.287 ± .012)	4.3 ± 0.3 (.169 ± .012)	4.0 ± 0.3 (.157 ± .012)	2.3 (.091)	2.4 (.094)	1.3 (.051)	0.5 (.020)	0.10 ± 0.10 (.004 ± .004)	1.7 (.067)	1.0 (.039)	0.13 (.005)	3.8 (.150)	3.5** (.138)	3.5** (.138)

T498 Ordering Information

T 498 X 227 M 010 A T E500

Tantalum ————

Series ————
498 – High Temp (150°C)

Case Size ————
A,B,C,D,X

Capacitance Picofarad Code ————
First two digits represent significant figures.
Third digit specifies number of zeros.

Capacitance Tolerance ————
M = ±20%
K = ±10%

ESR ————
Note: in mOhm
K designates “thousand”
E1K5 = 1.5 Ohm
E500 = 0.5 Ohm

Lead Material ————
T = 100% Tin
G = Gold
H = Tin/Lead
(SnPb 5% Pb min)

Failure Rate ————
A = Not Applicable

Voltage ————
Note: 006 = 6.3

T498 RATINGS & PART NUMBER REFERENCE

Capacitance μF	Case Size	KEMET Part Number	DC Leakage μA @ 25°C Max	DF % @ +25°C 120 Hz Max	ESR Ω @ +25°C 100 kHz Max
**6 Volt Rating at +85°C (4 Volt Rating at +150°C)					
10.0	B	T498B106(1)006A(2)E2K1	0.7	6.0	2.1
15.0	B	T498B156(1)006A(2)E1K8	1.0	6.0	1.8
22.0	C	T498C226(1)006A(2)E1K3	1.4	6.0	1.3
33.0	B	T498B336(1)006A(2)E1K7	2.1	6.0	1.7
47.0	C	T498C476(1)006A(2)E800	3.0	6.0	0.8
100.0	D	T498D107(1)006A(2)E600	6.3	8.0	0.6
10 Volt Rating at +85°C (7 Volt Rating at +150°C)					
2.2	A	T498A225(1)010A(2)E4K6	0.5	6.0	4.6
3.3	A	T498A335(1)010A(2)E3K6	0.5	6.0	3.6
4.7	A	T498A475(1)010A(2)E2K9	0.5	6.0	2.9
4.7	B	T498B475(1)010A(2)E2K7	0.5	6.0	2.7
10.0	B	T498B106(1)010A(2)E1K8	1.0	6.0	1.8
15.0	B	T498B156(1)010A(2)E1K5	1.5	6.0	1.5
15.0	C	T498C156(1)010A(2)E1K8	1.5	6.0	1.8
22.0	B	T498B226(1)010A(2)E1K5	2.2	6.0	1.5
22.0	C	T498C226(1)010A(2)E1K1	2.2	6.0	1.1
47.0	D	T498D476(1)010A(2)E600	4.7	6.0	0.6
100.0	D	T498D107(1)010A(2)E600	10.0	8.0	0.6
220.0	X	T498X227(1)010A(2)E500	22.0	8.0	0.5
16 Volt Rating at +85°C (11 Volt Rating at +150°C)					
1.0	A	T498A105(1)016A(2)E6K5	0.5	4.0	6.5
3.3	A	T498A335(1)016A(2)E3K4	0.5	6.0	3.4
4.7	B	T498B475(1)016A(2)E2K1	0.8	6.0	2.1
6.8	A	T498A685(1)016A(2)E2K6	1.1	6.0	2.6
6.8	B	T498B685(1)016A(2)E1K8	1.1	6.0	1.8
10.0	B	T498B106(1)016A(2)E2K8	1.6	6.0	2.8
10.0	C	T498C106(1)016A(2)E1K4	1.6	6.0	1.4
15.0	C	T498C156(1)016A(2)E1K1	2.4	6.0	1.1
22.0	C	T498C226(1)016A(2)E1K0	3.6	6.0	1.0
33.0	D	T498D336(1)016A(2)E600	5.3	6.0	0.6
47.0	D	T498D476(1)016A(2)E600	7.5	6.0	0.6
68.0	D	T498D686(1)016A(2)E600	10.8	6.0	0.6
100.0	X	T498X107(1)016A(2)E100	16.0	8.0	0.1
20 Volt Rating at +85°C (13 Volt Rating at +150°C)					
1.0	A	T498A105(1)020A(2)E5K9	0.5	4.0	5.9
10.0	C	T498C106(1)020A(2)E1K1	2.0	6.0	1.1
25 Volt Rating at +85°C (17 Volt Rating at +150°C)					
0.47	A	T498A474(1)025A(2)E8K5	0.5	4.0	8.5
2.2	B	T498B225(1)025A(2)E3K0	0.6	6.0	3.0
10.0	C	T498C106(1)025A(2)E1K1	2.5	6.0	1.1
15.0	D	T498D156(1)025A(2)E700	3.8	6.0	0.7
22.0	D	T498D226(1)025A(2)E600	5.5	6.0	0.6
33.0	D	T498D336(1)025A(2)E600	8.3	6.0	0.6
35 Volt Rating at +85°C (24 Volt Rating at +150°C)					
0.33	A	T498A334(1)035A(2)E11K	0.5	4.0	11.0
1.0	A	T498A105(1)035A(2)E10K	0.5	4.0	10.0
1.5	C	T498C155(1)035A(2)E3K3	0.5	6.0	3.3
3.3	C	T498C335(1)035A(2)E1K7	1.2	6.0	1.7
6.8	D	T498D685(1)035A(2)E900	2.4	6.0	0.9
10.0	D	T498D106(1)035A(2)E700	3.5	6.0	0.7
22.0	X	T498X226(1)035A(2)E500	7.7	6.0	0.5
33.0	X	T498X336(1)035A(2)E500	11.6	6.0	0.5
50 Volt Rating at +85°C (34 Volt Rating at +150°C)					
3.3	D	T498D335(1)050A(2)E1K1	1.7	6.0	1.1
10.0	D	T498D106(1)050A(2)E1K0	5.0	6.0	1.0

LAND PATTERN DIMENSIONS FOR REFLOW SOLDER

KEMET/ EIA Size Code	Pad Dimensions				
	Z	G	X	Y (Ref)	C (Ref)
A/3216-18	4.70	0.80	1.50	1.95	2.75
B/3528-21	5.00	1.10	2.50	1.95	3.05
C/6032-28	7.60	2.50	2.50	2.55	5.05
D/7343-31	8.90	3.80	2.70	2.55	6.35
X/7343-43	8.90	3.80	4.40	2.55	6.35

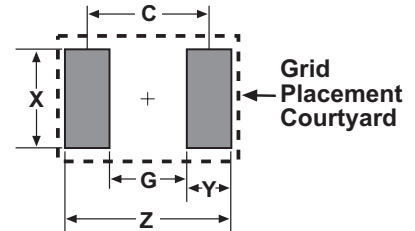

PACKAGING SPECIFICATIONS

Case Codes		Tape & Reel Dimensions				
KEMET	EIA	Tape Width (mm)	Pitch mm ± 0.1		Reel Quantity	
			Part	Sprocket	180mm (7")	330mm (13")
A	3216-18	8 ± 0.3	8	4	2000	9000
B	3528-21	8 ± 0.3	8	4	2000	8000
C	6032-28	12 ± 0.3	8	4	500	3000
D	7343-31	12 ± 0.3	8	4	500	2500
X	7343-43	12 ± 0.3	8	4	500	2000

COMPONENT MARKING

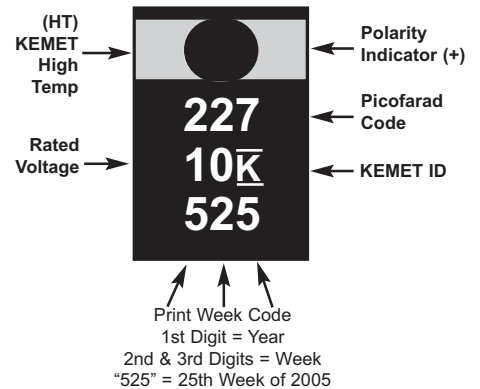

(1) To complete KEMET part number, insert K - ± 10% or M - ±20% capacitance tolerance.
 (2) To complete KEMET part number, insert T for 100% tin, H for Sn/Pb or G for gold.
 ** 6 volt product equivalent to 6.3 volt product.

Note: Higher voltage ratings, lower ESR and tighter capacitance tolerance product may be substituted within the same size at KEMET's option.
 Voltage substitutions will be marked with the higher voltage rating.

SOLID TANTALUM CHIP CAPACITORS

T510 SERIES—High Capacitance-Low ESR



FEATURES

- Ultra Low ESR < 30 mΩ
- New E/7260 Case with ESR < 18 mΩ
- Up to 5 Amps ripple current
- RoHS Compliant & Leadfree Termination (see www.kemet.com for lead transitions)
- Operating Temperature: -55°C to +125°C
- 100% accelerated steady-state aging
- 100% Surge current test
- Precision - molded, laser-marked case
- Symmetrical compliant terminations
- Taped and reeled per EIA 481-1

OUTLINE DRAWING

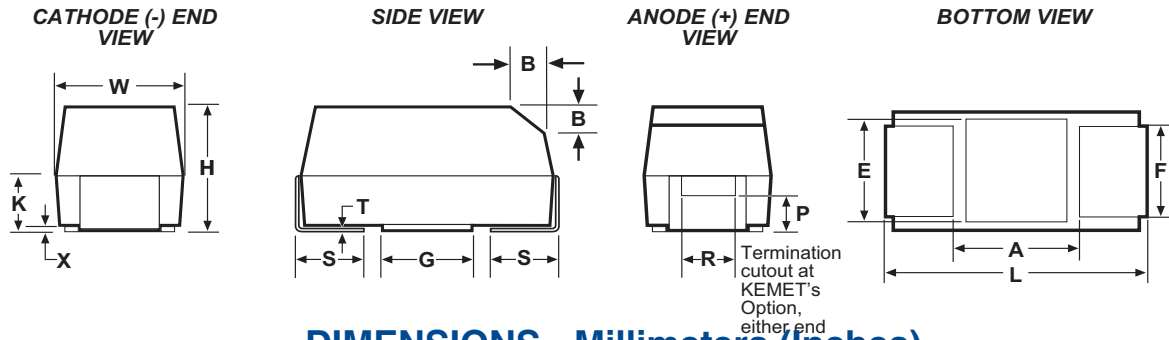

DIMENSIONS - Millimeters (Inches)

CASE SIZE		COMPONENT													
KEMET	EIA	L	W	H	K ± 0.20 ± (.008)	F ± 0.1 ± (.004)	S ± 0.3 ± (.012)	B ± 0.15 (Ref) ± (.006)	X (Ref)	P (Ref)	R (Ref)	T (Ref)	A (Min)	G (Ref)	E (Ref)
X	7343-43	7.3 ± 0.3 (.287 ± .012)	4.3 ± 0.3 (.169 ± .012)	4.0 ± 0.3 (.157 ± .012)	2.3 (.091)	2.4 (.094)	1.3 (.051)	0.5 (.020)	0.10 ± 0.10 (.004 ± .004)	0.9 (.035)	1.0 (.039)	0.13 (.005)	3.8 (.150)	3.5 (.138)	3.5 (.138)
E	7260-38	7.3 ± 0.3 (.287 ± .012)	6.0 ± 0.3 (.236 ± .012)	3.6 ± 0.2 (.142 ± .008)	2.3 (.091)	4.1 (.161)	1.3 (.051)	0.5 (.020)	0.10 ± 0.10 (.004 ± .004)	0.9 (.035)	1.0 (.039)	0.13 (.005)	3.8 (.150)	3.5 (.138)	3.5 (.138)

Notes: Metric Dimensions govern
(Ref) - Dimensions provided for reference only.

T510 RATINGS & PART NUMBER REFERENCE

Cap µF	Case Size	KEMET Part Number	DC Leakage µA @ +25°C Max	DF % @ +25°C 120Hz Max	ESR mΩ @ +25°C 100 kHz Max	Ripple Current Arms @ +25°C, 100 kHz, max		
						25°C	85°C	125°C
4 Volt Rating at +85°C (2.7 Volt Rating at 125°C)								
680.0	X	T510X687(1)004A(2)E030	27.2	6.0	30	3.0	2.7	1.2
1000.0	X	T510X108(1)004A(2)E018	40.0	6.0	18	3.9	3.5	1.5
1000.0	X	T510X108(1)004A(2)E023	40.0	6.0	23	3.4	3.0	1.3
1000.0	E	T510E108(1)004A(2)E018	40.0	6.0	18	4.0	3.6	1.6
1000.0	E	T510E108(1)004A(2)E010	40.0	6.0	10	5.3	4.8	2.1
6/6.3 Volt Rating at +85°C (4 Volt Rating at 125°C)								
470.0	X	T510X477(1)006A(2)E030	28.2	6.0	30	3.0	2.7	1.2
680.0	X	T510X687(1)006A(2)E023	42.8	6.0	23	3.4	3.1	1.4
680.0	E	T510E687(1)006A(2)E023	40.8	6.0	23	3.5	3.2	1.4
680.0	E	T510E687(1)006A(2)E012	40.8	6.0	12	4.8	4.3	1.9
10 Volt Rating at +85°C (7 Volt Rating at 125°C)								
330.0	X	T510X337(1)010A(2)E035	33.0	6.0	35	2.8	2.5	1.1
16 Volt Rating at +85°C (11 Volt Rating at 125°C)								
150.0	X	T510X157(1)016A(2)E030	24.0	6.0	30	3.0	2.7	1.2
150.0	X	T510X157(1)016A(2)E040	24.0	6.0	40	2.6	2.3	1.0
220.0	X	T510X227(1)016A(2)E040	35.2	10.0	40	2.6	2.3	1.0
220.0	X	T510X227(1)016A(2)E025	35.2	10.0	25	3.3	3.0	1.3

Cap µF	Case Size	KEMET Part Number	DC Leakage µA @ +25°C Max	DF % @ +25°C 120Hz Max	ESR mΩ @ +25°C 100 kHz Max	Ripple Current Arms @ +25°C, 100 kHz, max		
						25°C	85°C	125°C
20 Volt Rating at +85°C (13.4 Volt Rating at 125°C)								
100.0	X	T510X107(1)020A(2)E035	20.0	6.0	35.0	7.7	6.9	3.1
100.0	X	T510X107(1)020A(2)E040	20.0	6.0	40.0	2.6	2.3	1.0
100.0	X	T510X107(1)020A(2)E045	20.0	6.0	45.0	2.4	2.2	0.9
25 Volt Rating at +85°C (17 Volt Rating at 125°C)								
100.0	E	T510E107(1)025A(2)E050	25.0	8.0	50	2.4	2.1	1.0
35 Volt Rating at +85°C (23 Volt Rating at 125°C)								
22.0	X	T510X226(1)035A(2)E100	7.7	6.0	100	1.6	1.4	0.6
22.0	X	T510X226(1)035A(2)E080	7.7	6.0	80	1.8	1.7	0.7
22.0	X	T510X226(1)035A(2)E060	7.7	6.0	60	2.1	1.9	0.8
33.0	X	T510X336(1)035A(2)E065	11.6	6.0	65	2.0	1.8	0.8
33.0	X	T510X336(1)035A(2)E050	11.6	6.0	50	2.3	2.1	0.9
47.0	X	T510X476(1)035A(2)E055	16.5	8.0	55	2.2	2.0	0.9
47.0	X	T510X476(1)035A(2)E065	16.5	8.0	65	2.0	1.8	0.8
47.0	E	T510E476(1)035A(2)E050	16.5	8.0	50	2.4	2.1	1.0
50 Volt Rating at +85°C (33 Volt Rating at 125°C)								
10.0	X	T510X106(1)050A(2)E120	5.0	8.0	120	1.5	1.3	0.6
10.0	X	T510X106(1)050A(2)E090	5.0	8.0	90	1.7	1.6	0.7

(1) To complete KEMET part number insert "K" - ±10% or "M" - ±20% capacitance tolerance. (2) To complete KEMET part number, insert H (SnPb) or T - 100% tin.

T510 ORDERING INFORMATION

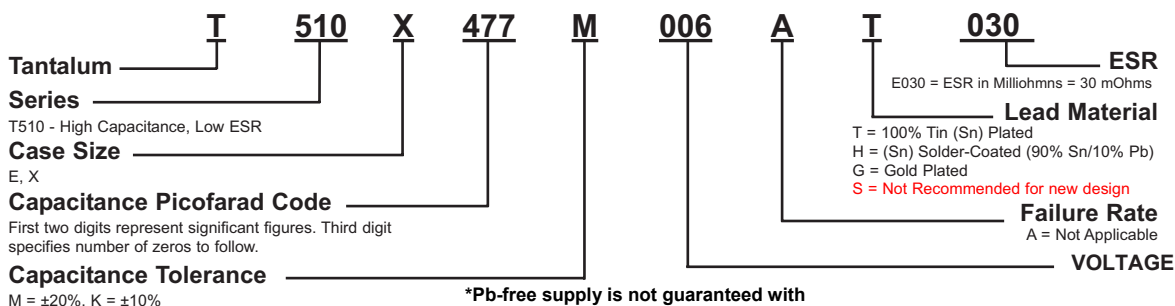

SOLID TANTALUM CHIP CAPACITORS

T510 SERIES—High Capacitance

TYPICAL CAP FREQUENCY SCAN @25°C
T510X477M006AS

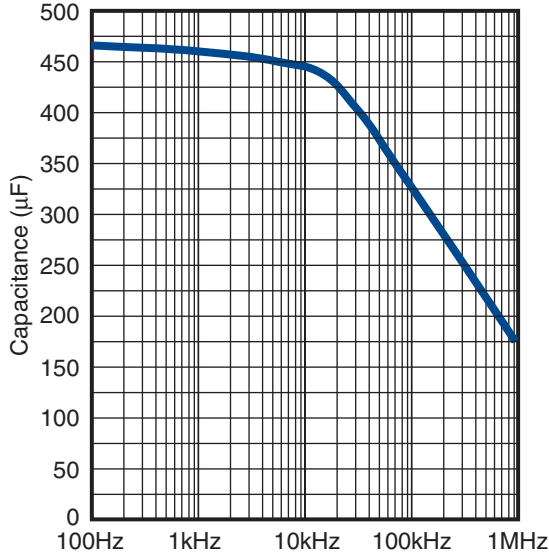

TYPICAL ESR/Z FREQUENCY SCAN @25°C
T510X477M006AS

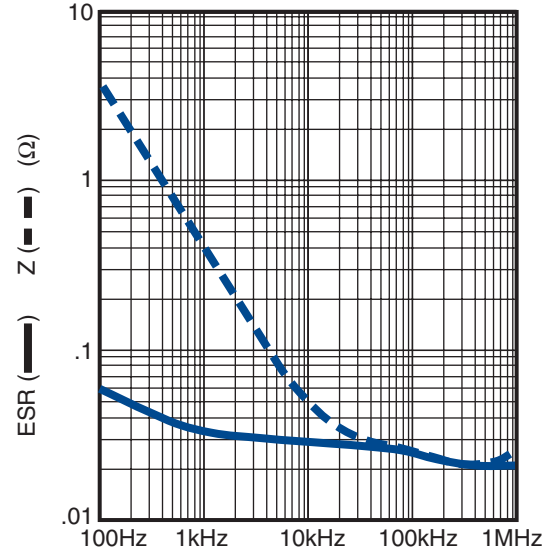

TYPICAL CAP FREQUENCY SCAN @ 25°C
T510E108M004AS

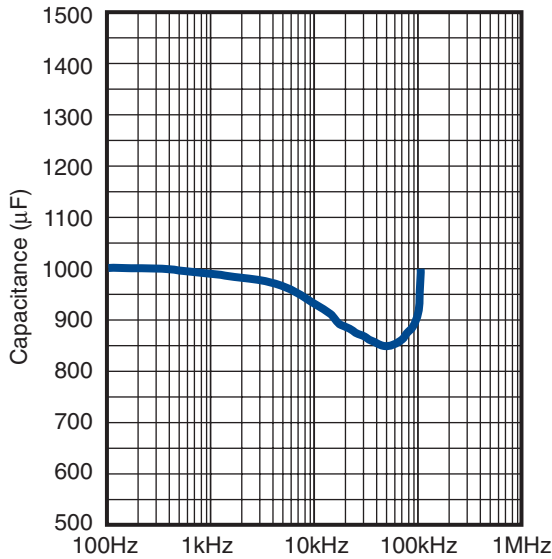

TYPICAL ESR/Z FREQUENCY SCAN @ 25°C
T510E108M004AS

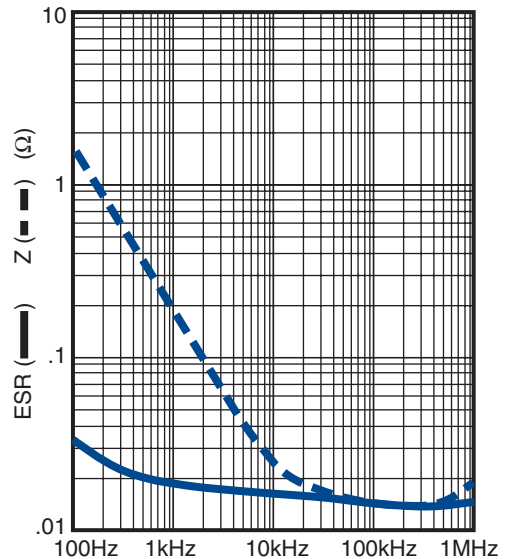

CAPACITOR ALTERNATE MARKINGS

Date Code Year	Date Code Month	
S = 2004	1 = Jan	7 = Jul
T = 2005	2 = Feb	8 = Aug
U = 2006	3 = Mar	9 = Sep
V = 2007	4 = Apr	10 = Oct
W = 2008	5 = May	11 = Nov
X = 2009	6 = Jun	12 = Dec

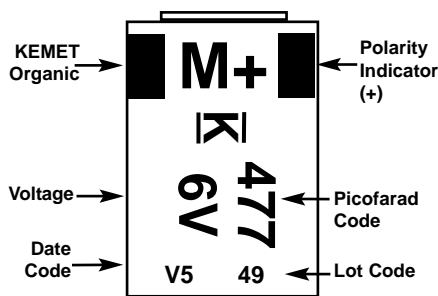

T510 CAPACITOR MARKINGS

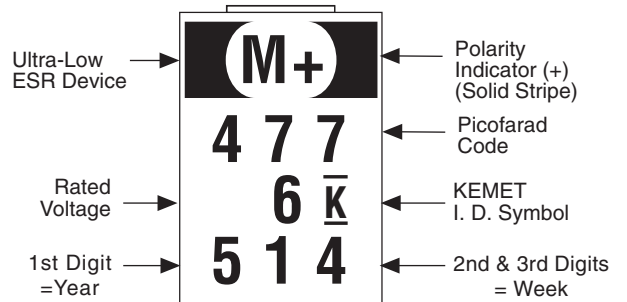

"514" = The 14th week of 2005.

COMPONENT PERFORMANCE CHARACTERISTICS

Introduction

KEMET has developed a new type of tantalum capacitor that replaces the solid manganese dioxide electrode with a solid conductive polymer. This product is named the KO-CAP for **KEMET Organic Capacitor**. The basic families are the T520, T525 and T530 series. A separate detail of performance characteristics is presented here as there are some differences between the polymer tantalums and the standard MnO₂ types. Like all KEMET tantalum chips, these series are 100% screened for all electrical parameters: Capacitance @ 120 Hz, Dissipation Factor (DF) @ 120 Hz, ESR @ 100 kHz and DC Leakage. It is also 100% surge current tested at full rated voltage through a low impedance circuit. The advantages of the polymer include very low ESR and elimination of the potentially catastrophic failure mode that may occur with standard tantalum capacitors in a high current application. Although the natural KO-CAP series failure mechanism is a short circuit, it does not exhibit an explosive failure mode.

ELECTRICAL

1. Operating Temperature Range

- -55°C to +105°C for T520; -55°C to +125°C for T525 and T530

For T525 and T530 Series above 105°C, the voltage rating is reduced linearly from 1.0 x rated voltage to 0.8 x rated voltage at 125°C.

2. Non-Operating Temperature Range

- -55°C to +105°C for T520
- -55°C to +125°C for T525 and T530

3. Capacitance and Tolerance

- 15µF to 1500µF
- ±20% Tolerance

Capacitance is measured at 120 Hz, up to 1.0 volt rms maximum and up to 2.5V DC maximum. DC bias causes only a small reduction in capacitance, up to about 2% when full rated voltage is applied. DC bias is not commonly used for room temperature measurements but is more commonly used when measuring at temperature extremes.

Capacitance does decrease with increasing frequency, but not nearly as much or as quickly as standard tantalums. Figure 1 compares the frequency induced cap roll-off between the KO-CAP and traditional MnO₂ types. Capacitance also increases with increasing temperature. See section 12 for temperature coefficients.

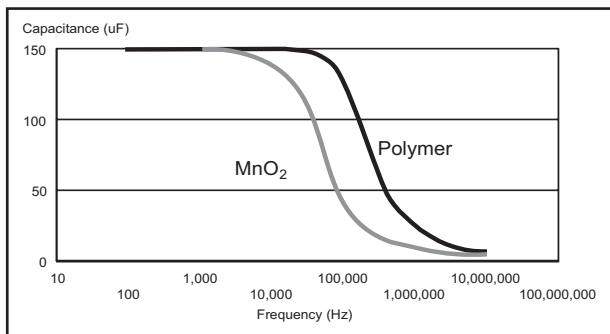
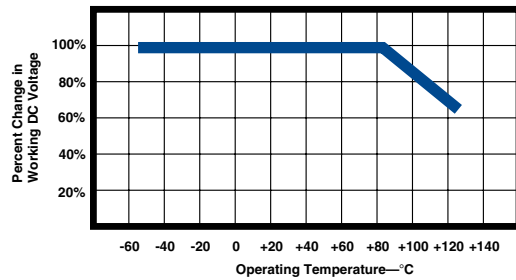

FIGURE 1

4. Voltage Ratings

- 2V-25V DC Rated Voltage

This is the maximum peak DC operating voltage from -55°C to +105°C for continuous duty. Above 105°C, this voltage is derated linearly to 2/3 the rated voltage for operation at 125°C for T525 and T530 Series.



• Surge Voltage Ratings

Surge voltage capability is demonstrated by application of 1000 cycles of the relevant voltage, at 25°C, 85°C or 105°C. The parts are charged through a 33 ohm resistor for 30 seconds and then discharged through a 33 ohm resistor for 30 seconds for each cycle.

• Voltage Ratings • Table 1

Rated Voltage	Surge Voltage	Derated Voltage	Derated Surge Voltage
-55°C to +105°C		+125°C	
2V	2.6V	1.6V	2.1V
2.5V	3.3V	2.0V	2.6V
3V	3.9V	2.4V	3.1V
4V	5.2V	3.2V	4.2V
6.3V	8.2V	5V	6.5V
8V	10.4V	6.4V	8.3V
10V	13V	8V	10.4V
16V	20.8V	12.8V	16.6V
25V	32.5V	20V	26V

5. Reverse Voltage Rating & Polarity

Polymer capacitors are polar devices and may be permanently damaged or destroyed if connected in the wrong polarity. The positive terminal is identified by a laser-marked stripe and may also include a beveled edge. These capacitors will withstand a small degree of transient voltage reversal for short periods as shown in the following table. Please note that these parts may not be operated continuously in reverse, even within these limits.

Table 2

Temperature	Permissible Transient Reverse Voltage
25°C	15% of Rated Voltage
55°C	10% of Rated Voltage
85°C	5% of Rated Voltage
85°C	5% of Rated Voltage
105°C	3% of Rated Voltage
125°C	1% of Rated Voltage

6. DC Leakage Current

Because of the high conductivity of the polymer, the KO-CAP family has higher leakage currents than traditional MnO₂ type Tantalum caps. The DC Leakage limits at 25°C are calculated as 0.1 x C x V, where C is cap in µF and V is rated voltage in Volts. Limits for all part numbers are listed in the ratings tables.

DC Leakage current is the current that flows through the capacitor dielectric after a five minute charging period at rated voltage. Leakage is measured at 25°C with full rated voltage applied to the capacitor through a 1000 ohm resistor in series with the capacitor.

COMPONENT PERFORMANCE CHARACTERISTICS

DC Leakage current does increase with temperature. The limits for 85°C @ Rated Voltage and 105°C @ 0.8 x Rated Voltage are both 10 times the 25°C limit.

7. Surge Current Capability

Certain applications may induce heavy surge currents when circuit impedance is very low (<0.1 ohm per volt). Driving inductance may also cause voltage ringing. Surge currents may appear as transients during turn-on of equipment.

The KO-CAP has a very high tolerance for surge current. And although the failure mechanism is a short circuit, they do not ignite as may occur with standard tantalums in such applications.

The KO-CAP series receives 100% screening for surge current in our production process. Capacitors are surged 4 times at full rated voltage applied through a total circuit resistance of <0.5 ohms. Failures are removed during subsequent electrical testing.

8. Dissipation Factor (DF)

Refer to part number tables for maximum DF limits.

Dissipation factor is measured at 120 Hz, up to 1.0 volt rms maximum, and up to 2.5 volts DC maximum at +25°C. The application of DC bias causes a small reduction in DF, about 0.2% when full rated voltage is applied. DF increases with increasing frequency.

Dissipation factor is the ratio of the equivalent series resistance (ESR) to the capacitive reactance, (X_c) and is usually expressed as a percentage. It is directly proportional to both capacitance and frequency. Dissipation factor loses its importance at higher frequencies, (above about 1 kHz), where impedance (Z) and equivalent series resistance (ESR) are the normal parameters of concern.

$$DF = \frac{R}{X_c} = 2 \pi f CR$$

DF= Dissipation Factor
 R= Equivalent Series Resistance (Ohms)
 X_c = Capacitive Reactance (Ohms)
 f= Frequency (Hertz)
 C= Series Capacitance (Farads)

DF is also referred to as $\tan \delta$ or “loss tangent.” The “Quality Factor,” “Q,” is the reciprocal of DF.

9. Equivalent Series Resistance (ESR) and Impedance (Z)

The Equivalent Series Resistance (ESR) of the KO-CAP is much lower than standard Tantalum caps because the polymer cathode has much higher conductivity. ESR is not a pure resistance, and it decreases with increasing frequency.

Total impedance of the capacitor is the vector sum of capacitive reactance (X_c) and ESR, below resonance; above resonance total impedance is the vector sum of inductive reactance (X_L) and ESR.

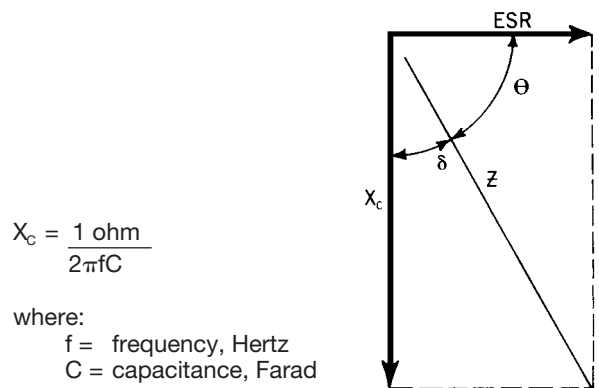

FIGURE 2a Total Impedance of the Capacitor Below Resonance

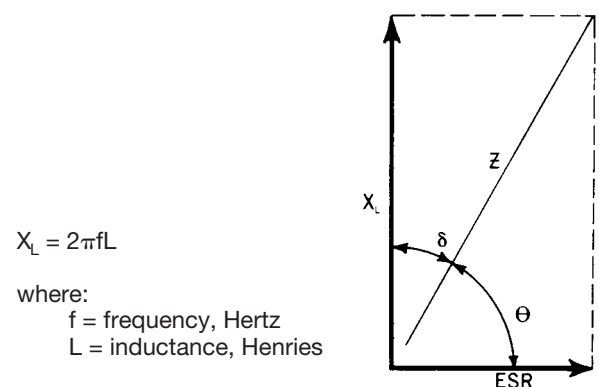

FIGURE 2b Total Impedance of the Capacitor Above Resonance

To understand the many elements of a capacitor, see Figure 3.

COMPONENT PERFORMANCE CHARACTERISTICS

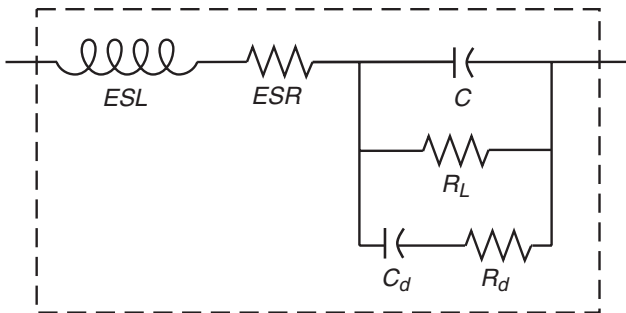

FIGURE 3 The Real Capacitor

A capacitor is a complex impedance consisting of many series and parallel elements, each adding to the complexity of the measurement system.

ESL — Represents lead wire and construction inductance. In most instances (especially in solid tantalum and monolithic ceramic capacitors) it is insignificant at the basic measurement frequencies of 120 and 1000 Hz.

ESR— Represents the actual ohmic series resistance in series with the capacitance. Lead wires and capacitor electrodes are contributing sources.

R_L — Capacitor Leakage Resistance. Typically it can reach 50,000 megohms in a tantalum capacitor. It can exceed 10^{12} ohms in monolithic ceramics and in film capacitors.

R_d — The dielectric loss contributed by dielectric absorption and molecular polarization. It becomes very significant in high frequency measurements and applications. Its value varies with frequency.

C_d — The inherent dielectric absorption of the solid tantalum capacitor which typically equates to 1-2% of the applied voltage.

As frequency increases, X_C continues to decrease according to its equation above. There is unavoidable inductance as well as resistance in all capacitors, and at some point in frequency, the reactance ceases to be capacitive and becomes inductive. This frequency is called the self-resonant point. In solid tantalum capacitors, the resonance is damped by the ESR, and a smooth, rather than abrupt, transition from capacitive to inductive reactance follows.

Figure 4 compares the frequency response of a KO-CAP to a standard Tantalum chip. Maximum limits for 100 kHz ESR are listed in the part number tables for each series.

The T530 Capacitance, Impedance and ESR vs. Frequency Comparisons are located on page 57. Maximum limits for 100 kHz are listed in the part number table on page 56.

ESR and Impedance

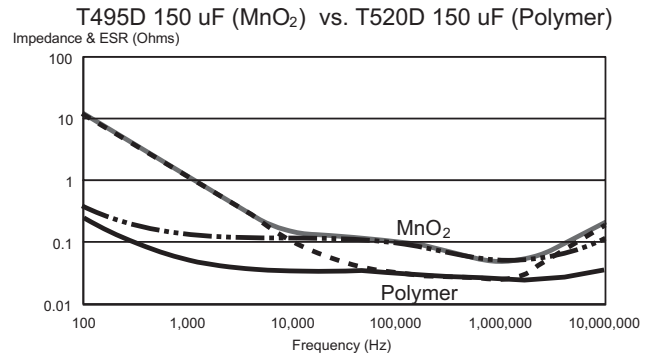

FIGURE 4

10. AC Power Dissipation

Power dissipation is a function of capacitor size and materials. Maximum power ratings have been established for all case sizes to prevent overheating. In actual use, the capacitor's ability to dissipate the heat generated at any given power level may be affected by a variety of circuit factors. These include board density, pad size, heat sinks and air circulation.

**Table 3
Power Dissipation Ratings**

Case Code		Maximum Power Dissipation mWatts @ +25°C w/+20°C Rise
KEMET	EIA	
T520/T	3528-12	70
T520/A	3216-18	75
T52x/B	3528-21	85
T520/U	6032-15	90
T520/C	6032-28	110
T520/W	7343-15	120
T520/V	7343-20	125
T52x/D	7343-31	150
T520/Y	7343-40	161
T520/X	7343-43	165
T530/D	7343-31	255
T530/Y	7343-40	263
T530/X	7343-43	270
T530/E	7260-38	285

11. Ripple Current/ Ripple Voltage

Permissible AC ripple voltage and current are related to equivalent series resistance (ESR) and power dissipation capability.

Permissible AC ripple voltage which may be applied is limited by three criteria:

- The positive peak AC voltage plus the DC bias voltage, if any, must not exceed the DC voltage rating of the capacitor.
- The negative peak AC voltage, in combination with bias voltage, if any, must not exceed the permissible reverse voltage ratings presented in Section 5.
- The power dissipated in the ESR of the capacitor must not exceed the appropriate value specified in Section 10.

COMPONENT PERFORMANCE CHARACTERISTICS

Actual power dissipated may be calculated from the following:

$$P = I^2 R$$

$$\text{Substituting } I = \frac{E}{Z}, \quad P = \frac{E^2 R}{Z^2}$$

where:

I = rms ripple current (amperes)

E = rms ripple voltage (volts)

P = power (watts)

Z = impedance at specified frequency (ohms)

R = equivalent series resistance at specified frequency (ohms)

Using P max from Table 3, maximum allowable rms ripple current or voltage may be determined as follows:

$$I(\text{max}) = \sqrt{P \text{ max}/R} \quad E(\text{max}) = Z \sqrt{P \text{ max}/R}$$

14. High Temperature Life Test - 2000 Hours

- 105°C, T520 - 1.0 x Rated Voltage;
- 125°C, T525, T530 - .67 x Rated Voltage

Post Test Performance:

- Capacitance: within -20%/+10% of initial value
- DF: within initial limit
- DC Leakage: within 1.25 initial limits for T520; 2 x initial limit for T525, T530
- ESR: within 2 x initial limit for T520, T530
ESR: within initial limit for T525

15. Storage Life Test

- 105°C, 0VDC, 2000 Hours for T520; 125°C for T525, T530

Post Test Performance:

- Capacitance: within -20%/+10% of initial value
- DF: within initial limit
- DC Leakage: within 1.25 initial limits for T520; 2 x initial limit for T525, T530
- ESR: within 2 x initial limit for T520, T530
ESR: within initial limit for T525

16. Thermal Shock

- Mil-Std-202, Method 107, Condition B

Minimum temperature is -55°C

Maximum temperature is +105°C for T520; 125°C for T525, T530

500 Cycles

Post Test Performance:

- Capacitance: within +10%/-20% of initial value
- DF: within initial limit
- DC Leakage: within initial limit
- ESR: within 2 x initial limit

17. Moisture Resistance Testing

- J-Std-020

Steps 7a and 7b excluded, 0V, 21 cycles

Post Test Performance:

- Capacitance: within ±30% of initial value
- DF: within initial limit
- DC Leakage: within initial limit
- ESR: within initial limit
- JEDEC J-STD-020C Meets MSL Level 3

18. Load Humidity

- 85°C, 85% RH, Rated Voltage, 500 Hours

Post Test Performance:

- Capacitance: within +35%/-5% of initial value
- DF: within initial limit
- DC Leakage: within 5 x initial limit
- ESR: within 2 x initial limit

19. ESD

- Polymer tantalum capacitors are not sensitive to Electro-Static Discharge (ESD).

20. Failure Mechanism and Reliability

The normal failure mechanism is dielectric breakdown. Dielectric failure can result in high DC Leakage current and may proceed to the level of a short circuit. With sufficient time to charge, healing may occur by one of two potential mechanisms. The polymer adjacent to the dielectric fault site may overheat and vaporize, disconnecting the fault site from the circuit. The polymer may also

ENVIRONMENTAL

12. Temperature Stability

Mounted capacitors withstand extreme temperature testing at a succession of continuous steps at +25°C, -55°C, +25°C, +85°C, +105°C, +25°C in that order*. Capacitors are allowed to stabilize at each temperature before measurement. Cap, DF, and DCL are measured at each temperature except DC Leakage is not measured at -55°C.

*Maximum temperature 125°C for T525 and T530 series.

Table 4

Acceptable limits are as follows:

Step	Temp.	ΔCap	DCL	DF
1	+25°C	Specified Tolerance	Catalog Limit	Catalog Limit
2	-55°C	±20% of initial value	N/A	Catalog Limit
3	+25°C	±10% of initial value	Catalog Limit	Catalog Limit
4	+85°C	±20% of initial value	10x Catalog Limit	1.2x Catalog Limit
5	+105°C (125°C for T525, T530)	±30% of initial value	10x Catalog Limit	1.5x Catalog Limit
6	+25°C	±10% of initial value	Catalog Limit	Catalog Limit

13. Standard Life Test

- 85°C, Rated Voltage, 2000 Hours

Post Test Performance:

- Capacitance: within -20%/+10% of initial value
- DF: within initial limit
- DC Leakage: within initial limit
- ESR: within initial limit

COMPONENT PERFORMANCE CHARACTERISTICS

oxidize into a more resistive material that eliminates the defect site in the dielectric and reduces the flow of current.

Capacitor failure may be induced by exceeding the rated conditions of forward DC voltage, reverse DC voltage, surge current, power dissipation or temperature. Excessive environmental stress, such as prolonged or high temperature reflow processes may also trigger dielectric failure.

Failure rates may be improved in application by derating the voltage applied to the capacitor. KEMET recommends that KO-CAPs be derated to 90% or less of the rated voltage in application for part types ≤ 10V. Parts > 10V should be derated to 80% or less of the rated voltage.

KO-CAPs exhibit a benign failure mode in that they do not fail catastrophically even under typical fault conditions. If a shorted capacitor is allowed to pass unlimited current, it may overheat and the case may discolor. But this is distinctly different from the “ignition” that may occur with standard MnO₂ cathode tantalums. Replacement of the MnO₂ by the polymer removes the oxygen that fuels ignition during a failure event.

MECHANICAL

21. Resistance to Solvents

- *Mil-Std-202, Method 213*

Post Test Performance:

- Capacitance — within ±10% of initial value
- DC Leakage — within initial limit
- Dissipation Factor — within initial limit
- ESR — within initial limit
- Physical — no degradation of case, terminals or marking

22. Fungus

- *Mil-Std-810, Method 508*

23. Flammability

- *UL94 VO Classification*

Encapsulant materials meet this classification

24. Resistance to Soldering Heat

- *Maximum Reflow*

+240 ±5°C, 10 seconds

- *Typical Reflow*

+230 ±5°C, 30 seconds

Post Test Performance:

- Capacitance — within ±10% of initial value
- DC Leakage — within initial limit
- Dissipation Factor — within initial limit
- ESR — within initial limit

25. Solderability

- *Mil-Std-202, Method 208*

- *ANSI/J-STD-002, Test B*

Applies to Solder Coated terminations only.

26. Vibration

- *Mil-Std-202, Method 204, Condition D, 10 Hz to 2,000 Hz, 20G Peak*

Post Test Performance:

- Capacitance — within ±10% of initial value
- DC Leakage — within initial limit
- Dissipation Factor — within initial limit
- ESR — within initial limit

27. Shock

- *Mil-Std-202, Method 213, Condition I, 100 G Peak*

Post Test Performance:

- Capacitance — within ±10% of initial value
- DC Leakage — within initial limit
- Dissipation Factor — within initial limit
- ESR - within initial limit

28. Terminal Strength

- **Pull Force**

- **One Pound (454 grams), 30 Seconds**

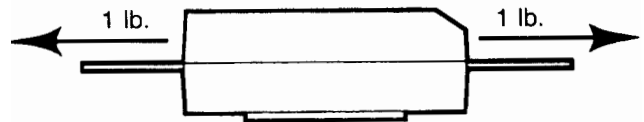

- **Tensile Force**

- **Four Pounds (1.8 kilograms), 60 Seconds**

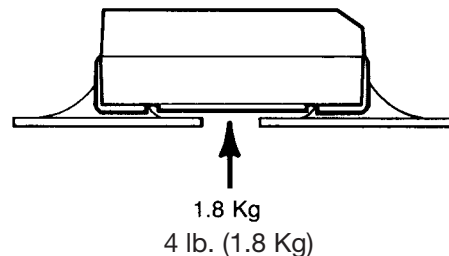

- **Shear Force**

Table 5 Maximum Shear Loads

Case Code		Maximum Shear Loads	
KEMET	EIA	Kilograms	Pounds
A	3216-18	3.2	7.0
T	3528-12	3.6	8.0
B	3528-21	3.6	8.0
C	6032-28	4.5	10.0
V	7343-20	5.0	11.0
W	7343-15	5.0	11.0
D	7343-31	5.0	11.0
Y	7343-40	5.0	11.0
X	7343-43	5.0	11.0

Post Test Performance:

- Capacitance — within ±5% of initial value
- DC Leakage — within initial limit
- Dissipation Factor — within initial limit
- ESR - within initial limit

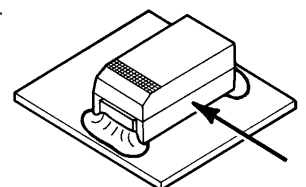

COMPONENT PERFORMANCE CHARACTERISTICS

APPLICATIONS

29. Handling

Automatic handling of encapsulated components is enhanced by the molded case which provides compatibility with all types of high speed pick and place equipment. Manual handling of these devices presents no unique problems. Care should be taken with your fingers, however, to avoid touching the solder-coated terminations as body oils, acids and salts will degrade the solderability of these terminations. Finger cots should be used whenever manually handling all solderable surfaces.

30. Termination Coating

KEMET's standard termination finish is 100% Sn. Standard terminations can be ordered with a "T" suffix in the lead material designator of the KEMET part number. Components ordered with the "T" suffix are Pb-Free/RoHS compliant and are backward and forward compatible with SnPb and Pb-Free soldering processes.

90Sn/10Pb terminations are also available and can be ordered with an "H" suffix.

KEMET's "S" suffix remains an active termination designator for current designs but is not recommended for new designs. Parts ordered with an "S" suffix are not guaranteed to be Pb-Free or RoHS compliant. Refer to www.kemet.com for information on Pb-Free transition.

31. Recommended Mounting Pad Geometries

Proper mounting pad geometries are essential for successful solder connections. These dimensions are highly process sensitive and should be designed

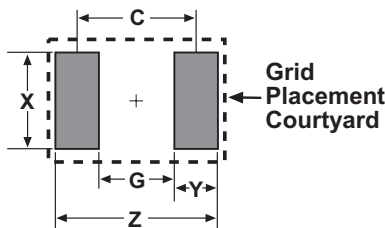

Table 6 - Land Pattern Dimensions for Reflow Solder

KEMET/EIA Size Code	Pad Dimensions				
	Z	G	X	Y (ref)	C (ref)
B/3528-21, T/3528-12	5.00	1.10	2.50	1.95	3.05
C/6032-28	7.60	2.50	2.50	2.55	5.05
D/7343-31, V/7343-20, W/7343-15, X/7343-43, Y/7343-40	8.90	3.80	2.70	2.55	6.35

to maximize the integrity of the solder joint, and to minimize component rework due to unacceptable solder joints.

Figure 5 illustrates pad geometry. The table provides recommended pad dimensions for reflow soldering techniques. These dimensions are intended to be a starting point for circuit board designers, to be fine tuned, if necessary, based upon the peculiarities of the soldering process and/or circuit board design.

Visit KEMET.com for Engineering Bulletin Number F-2100 entitled "Surface Mount Mounting Pad Dimensions and Considerations" for further details on this subject.

32. Soldering

The T52X KO-CAP family has been designed for reflow solder processes. Solder-coated terminations have excellent wetting characteristics for high integrity solder fillets. Preheating of these components is recommended to avoid extreme thermal stress. Pb (lead) Free peak temperature is 260°C (with up to 3x reflow capabilities).

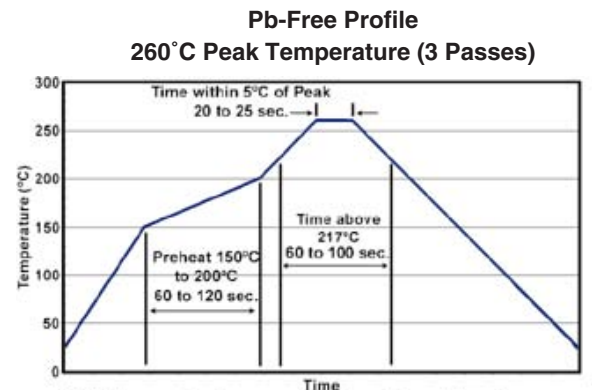
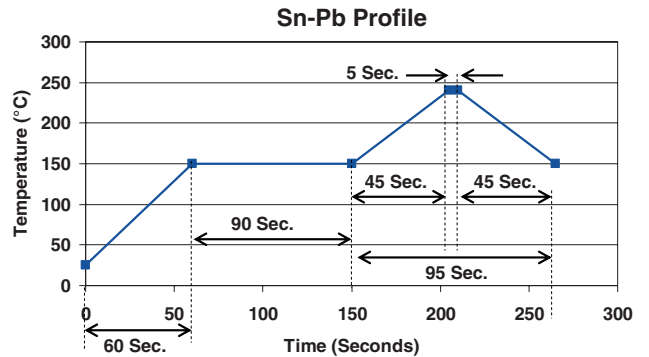

NOTE: Temperature is measured on the surface of the part

Time/Temperature Soldering Profile

Hand-soldering should be avoided. If necessary, it should be performed with care due to the difficulty in process control. Care should be taken to avoid contact of the soldering iron to the molded case.

The iron should be used to heat the solder pad, applying solder between the pad and the termination, until reflow occurs. The iron should be removed. "Wiping" the edges of a chip and heating the top surface is not recommended.

During typical reflow operations a slight darkening of the gold-colored epoxy may be observed. This slight darkening is normal and is not harmful to the product. Marking permanency is not affected by this change.

The EIA standards for conductive polymer capacitors allows an ESR movement to 1.1 times (or 3 milliohms, whichever is greater) the catalog limit past mounting.

33. Washing

Standard washing techniques and solvents are compatible with all KEMET surface mount tantalum capacitors. Solvents such as Freon TMC and TMS, Trichlorethane, methylene chloride, prelete, and isopropyl alcohol are not harmful to these components. Please note that we are not endorsing the use of banned or restricted solvents. We are simply stating that they would not be harmful to the components.

If ultrasonic agitation is utilized in the cleaning process, care should be taken to minimize energy levels and exposure times to avoid damage to the terminations.

KEMET tantalum chips are also compatible with newer aqueous and semi-aqueous processes.

34. Encapsulations

Under normal circumstances, potting or encapsulation of KEMET tantalum chips is not required.

35. Storage Environment

Conductive polymer series (T520, T525, T530) are shipped in moisture barrier bags with a desiccant and moisture indicator card. These series are classified as MSL (Moisture Sensitivity Level 3). Upon opening the moisture barrier bag, parts should be mounted within 7 days to prevent moisture absorption and outgassing. If the 7 day window is exceeded, the parts can be baked per the instructions on the bag (168 hours at 40±5°C).

Polymer chip capacitors should be stored in normal working environments. While the chips themselves are quite robust in other environments, solderability will be degraded by exposure to high temperatures, high humidity, corrosive atmospheres, and long term storage. In addition, packaging materials will be degraded by high temperature - reels may soften or warp, and tape peel force may increase. KEMET recommends that maximum storage temperature not exceed 40 degrees C, and the maximum storage humidity not exceed 60% relative humidity. In addition, temperature fluctuations should be minimized to avoid condensation on the parts, and atmospheres should be free of chlorine and sulfur bearing compounds. For optimized solderability, chip stock should be used promptly, preferably within 1.5 years of receipt.

COMPONENT WEIGHTS

Series	Case Size	Typical Weight (mg)
T52x	A/3216-18	35
T52x	B/3528-21	65
T52x	C/6032-28	130
T52x	D/7343-31	325
T52x	X/7343-43	500
T52x	T/3528-12	38
T52x	W/7343-15	172
T52x	V/7343-20	210
T530	D/7343-31	342
T530	Y/7343-40	480
T530	X/7343-43	515
T530	E/7360-38	650

KEMET CHARGED™ CONDUCTIVE POLYMER CHIP CAPACITORS

T520 Series - KO Cap

FEATURES

- Polymer Cathode Technology
- Low ESR
- High Frequency Cap Retention
- No-Ignition Failure Mode
- Use Up to 90% of Rated Voltage (10% Derating) for part types ≤ 10 Volts
- Halogen Free Epoxy
- 100% Accelerated Steady State Aging
- Volumetrically Efficient
- Use Up to 80% of Rated Voltage (20% Derating) for part types > 10 Volts
- Capacitance 15 to 1000 μ F ($\pm 20\%$)
- Voltage 2V to 25V
- EIA Standard Case Sizes
- 100% Surge Current Tested
- Operating Temperature -55°C to $+105^{\circ}\text{C}$
- Self Healing Mechanism
- RoHS Compliant & Leadfree Terminations (see www.kemet.com for lead transition)

OUTLINE DRAWING

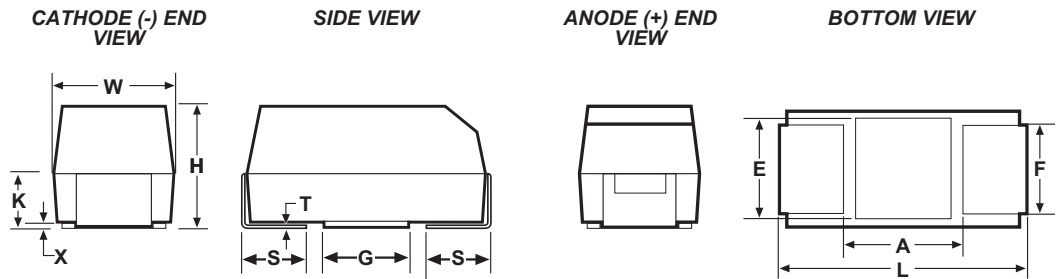

DIMENSIONS - MILLIMETERS

Case Size		L	W	H	K ± 0.20	F ± 0.1	S ± 0.3	X(Ref)	T(Ref)	A(Min)	G(ref)	E(ref)
KEMET	EIA											
A	3216-18	3.2 ± 0.2	1.6 ± 0.2	1.6 ± 0.2	0.9	1.2	0.8	0.10 ± 0.10	0.13	1.4	1.1	1.3
T	3528-12	3.5 ± 0.2	2.8 ± 0.2	1.2 max	0.3	2.2	0.8	0.05	0.13	2.1	1.8	2.2
B	3528-21	3.5 ± 0.2	2.8 ± 0.2	1.9 ± 0.2	0.9	2.2	0.8	0.10 ± 0.10	0.13	2.1	1.8	2.2
C	6032-28	6.0 ± 0.3	3.2 ± 0.3	2.5 ± 0.3	1.4	2.2	1.3	0.10 ± 0.10	0.13	3.1	2.8	2.4
U	6032-15	6.0 ± 0.3	3.2 ± 0.3	1.5 max	0.5	2.2	1.3	0.05	0.13	3.1	2.8	2.4
W	7343-15	7.3 ± 0.3	4.3 ± 0.3	1.5 max	0.6	2.4	1.3	0.05	0.13	3.8	3.5	3.5
V	7343-20	7.3 ± 0.3	4.3 ± 0.3	1.9 max	0.9	2.4	1.3	0.05	0.13	3.8	3.5	3.5
D	7343-31	7.3 ± 0.3	4.3 ± 0.3	2.8 ± 0.3	1.5	2.4	1.3	0.10 ± 0.10	0.13	3.8	3.5	3.5
Y	7343-40	7.3 ± 0.3	4.3 ± 0.3	4.0 max	1.9	2.4	1.3	0.10 ± 0.10	0.13	3.8	3.5	3.5
X	7343-43	7.3 ± 0.3	4.3 ± 0.3	4.0 ± 0.3	2.3	2.4	1.3	0.10 ± 0.10	0.13	3.8	3.5	3.5

T520 ORDERING INFORMATION

T 520 V 157 M 006 A S E015

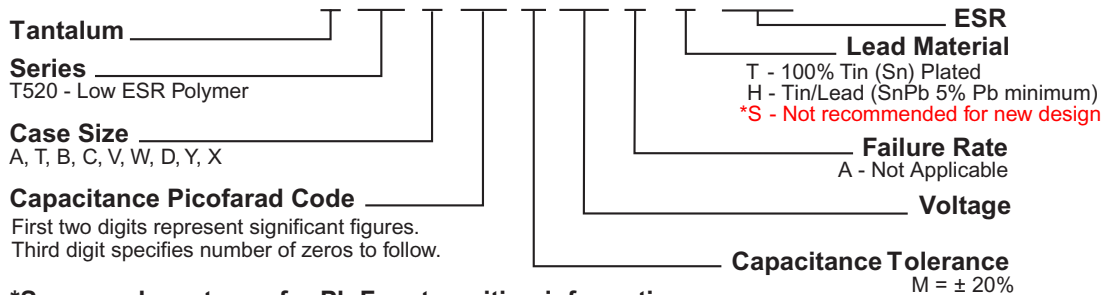

*See www.kemet.com for Pb Free transition information.

*Pb-free supply is not guaranteed with the 'S' termination code.

This termination code not available effective 15 July 2007.

COMPONENT MARKING

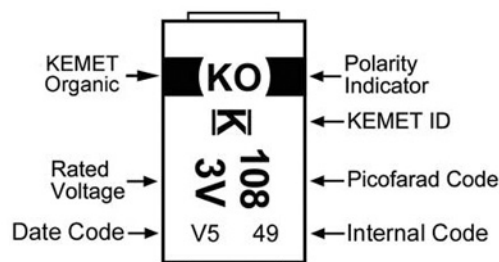
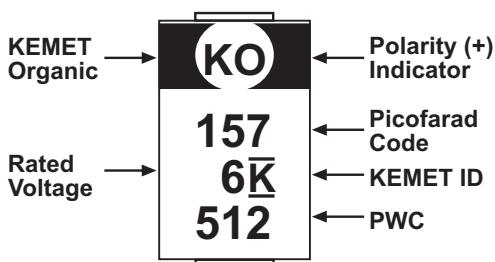

Date Code:		
Year	Month	
S = 2004	1 = January	7 = July
T = 2005	2 = February	8 = August
U = 2006	3 = March	9 = September
V = 2007	4 = April	O = October
W = 2008	5 = May	N = November
X = 2009	6 = June	D = December

512 = 12th week of 2005

FEATURES

- Polymer Cathode Technology
- 125°C Maximum Temperature Capability
- High Frequency Capacitance Retention
- Non-Ignition Failure Mode
- Capacitance: 33 - 680µF
- Voltage: 2.5 to 16 volts
- Use up to 90% of Rated Voltage (10% Derating) for part types ≤ 10 Volts
- Use up to 80% of Rated Voltage (20% Derating) for part types >10 Volts
- Operating Temperature -55°C to +125°C
- 100% Accelerated Steady State Aging
- 100% Surge Current Testing
- Self-Healing Mechanism
- Volumetrically Efficient
- Extremely Stable ESR at 125°C
- EIA Standard Case Size
- RoHS Compliant / Leadfree Termination (See www.kemet.com for lead transition)

OUTLINE DRAWING

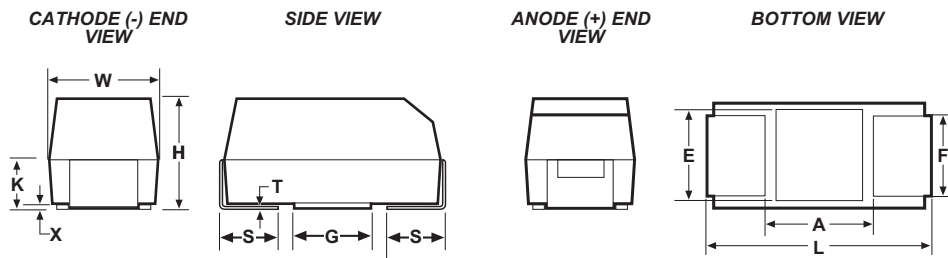

DIMENSIONS - MILLIMETERS

Case Size		L	W	H	K ±0.20	F ±0.1	S ±0.3	X (Ref)	T (Ref)	A (Min)	G (Ref)	E (Ref)
KEMET	EIA											
T	3528-12	3.5 ± 0.2	2.8 ± 0.2	1.2 max.	0.3	2.2	0.8	0.05	0.13	2.1	1.8	2.2
B	3528-21	3.5 ± 0.2	2.8 ± 0.2	1.9 ± 0.1	0.9	2.2	0.8	0.10 ± 0.10	0.13	2.1	1.8	2.2
D	7343-31	7.3 ± 0.3	4.3 ± 0.3	2.8 ± 0.3	1.5	2.4	1.3	0.10 ± 0.10	0.13	3.8	3.5	3.5

RECOMMENDED TEMPERATURE/VOLTAGE DERATING

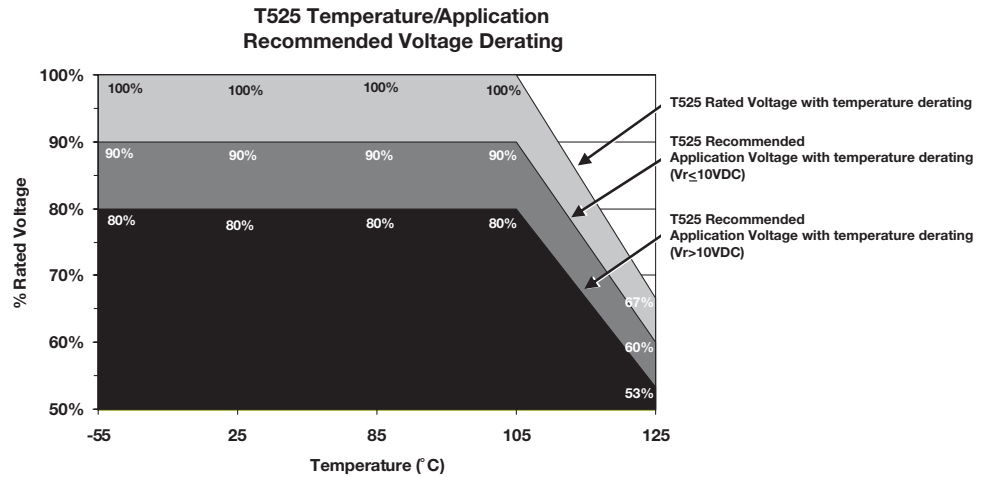

COMPONENT MARKING

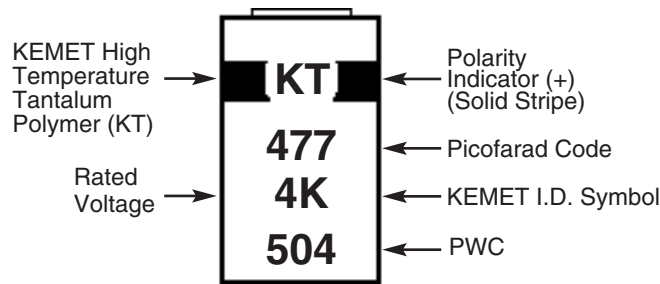

504=4th week of 2005

CONDUCTIVE POLYMER CHIP CAPACITORS

T525 SERIES - High Temperature



T525 RATINGS & PART NUMBER REFERENCE

Capacitance μF	Case Size	KEMET Part Number	DC Leakage μA @ 25°C Max	DF% @ 25°C 120 Hz Max	ESR $\text{m}\Omega$ @ 25°C 100 kHz Max	Ripple Current (Arms) 100 kHz Max	
						w/ ΔT = 20°C @ -55°C to 105°C	w/ ΔT = 2°C @ 125°C
2.5 Volt Rating at 105°C (1.7 Volt Rating at 125°C)							
100.0	T	T525T107M2R5A(1)E080	25	8.0	80	0.9	0.3
330.0	D	T525D337M2R5A(1)E025	83	10.0	25	2.4	0.8
470.0	D	T525D477M2R5A(1)E025	118	10.0	25	2.4	0.8
680.0	D	T525D687M2R5A(1)E025	170	10.0	25	2.4	0.8
3 Volt Rating at 105°C (2 Volt Rating at 125°C)							
100.0	B	T525B107M003A(1)E080	30	8.0	80	1.0	0.3
150.0	B	T525B157M003A(1)E080	45	8.0	80	1.0	0.3
330.0	D	T525D337M003A(1)E025	99	10.0	25	2.4	0.8
470.0	D	T525D477M003A(1)E025	141	10.0	25	2.4	0.8
680.0	D	T525D687M003A(1)E025	204	10.0	25	2.4	0.8
4 Volt Rating at 105°C (2.7 Volt Rating at 125°C)							
68.0	T	T525T686M004A(1)E080	27	8.0	80	0.9	0.3
68.0	B	T525B686M004A(1)E080	28	8.0	80	1.0	0.3
100.0	B	T525B107M004A(1)E080	40	8.0	80	1.0	0.3
220.0	D	T525D227M004A(1)E025	88	10.0	25	2.4	0.8
330.0	D	T525D337M004A(1)E025	132	10.0	25	2.4	0.8
470.0	D	T525D477M004A(1)E025	188	10.0	25	2.4	0.8
470.0	D	T525D477M004A(1)E040	188	10.0	40	1.9	0.6
6.3 Volt Rating at 105°C (4.2 Volt Rating at 125°C)							
33.0	B	T525B336M006A(1)E080	21	8.0	80	1.0	0.3
47.0	T	T525T476M006A(1)E080	30	8.0	80	0.9	0.3
47.0	B	T525B476M006A(1)E080	30	8.0	80	1.0	0.3
68.0	B	T525B686M006A(1)E080	43	8.0	80	1.0	0.3
150.0	D	T525D157M006A(1)E025	95	10.0	25	2.4	0.8
220.0	D	T525D227M006A(1)E025	139	10.0	25	2.4	0.8
330.0	D	T525D337M006A(1)E025	208	10.0	25	2.4	0.8
330.0	D	T525D337M006A(1)E040	208	10.0	40	1.9	0.6
8 Volt Rating at 105°C (5.3 Volt Rating at 125°C)							
33.0	T	T525T336M008A(1)E080	26	8.0	80	0.9	0.3
10 Volt Rating at 105°C (6.6 Volt Rating at 125°C)							
22.0	B	T525B226M010A(1)E080	22	8.0	80	1.0	0.3
33.0	T	T525T336M010A(1)E080	33	8.0	80	0.9	0.3
33.0	B	T525B336M010A(1)E080	33	8.0	80	1.0	0.3
100.0	D	T525D107M010A(1)E025	100	10.0	25	2.4	0.8
100.0	D	T525D107M010A(1)E055	100	10.0	55	1.7	0.5
150.0	D	T525D157M010A(1)E025	150	10.0	25	2.4	0.8
150.0	D	T525D157M010A(1)E055	150	10.0	55	1.7	0.5
220.0	D	T525D227M010A(1)E025	220	10.0	25	2.4	0.8
16 Volt Rating at 105°C (10.6 Volt Rating at 125°C)							
47.0	D	T525D476M016A(1)E035	76	10.0	35	2.1	0.7
47.0	D	T525D476M016A(1)E065	76	10.0	65	1.5	0.5

Conductive Polymer Surface Mount

(1) To complete KEMET Part Number, insert lead material designation for ordering information below. Higher voltage ratings and tighter tolerance product may be substituted within the same size at KEMET'S option. Voltage substitutions will be marked with the higher voltage rating.

T525 ORDERING INFORMATION

T 525 D 337 M 006 A T E040

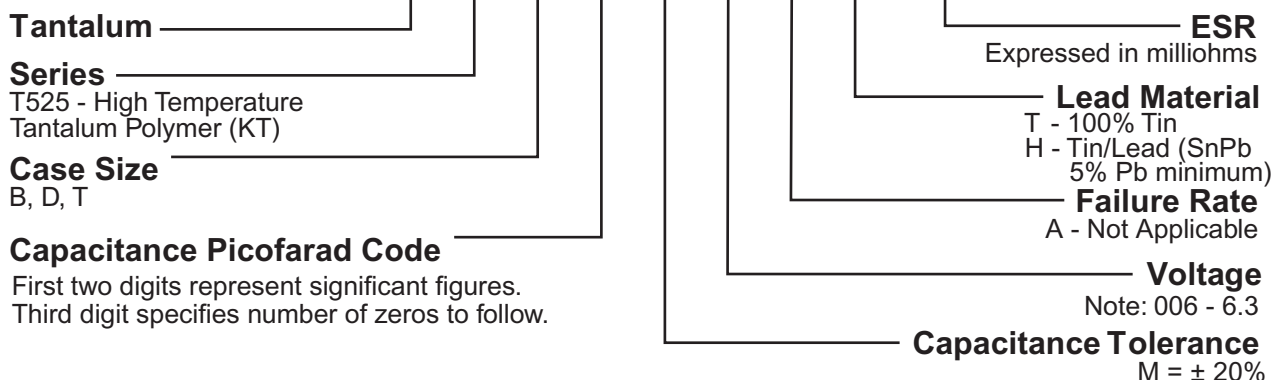

FEATURES

- Highest CV in Standard EIA Size
- Extremely Low ESR
- Operating Temperature: -55°C to 125°C
- Polymer Cathode Technology
- High Frequency Capacitance Retention
- Non-Ignition Failure Mode
- Capacitance: 150 to 1500 μF
- Voltage: 2.5V to 10V
- Molded Case (pick-and-place precision)
- 100% Accelerated Steady State Aging
- 100% Surge Current Testing
- Utilizes Multiple Tantalum Anode Technology
- Volumetric Efficiency
- Use Up to 90% of Rated Voltage (10% Derating)
- Self-Healing Mechanism
- True SMT Capability
- RoHS Compliant/Lead Free

OUTLINE DRAWINGS

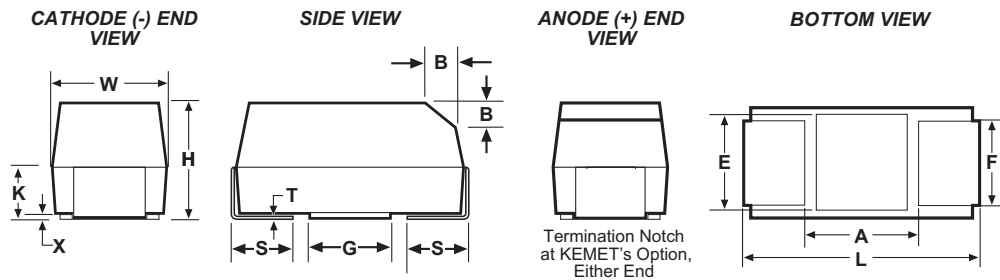

DIMENSIONS - MILLIMETERS (INCHES)

Case Size		L	W	H	K ±0.20	F ±0.1	S ±0.3	X(Ref)	T(Ref)	A(Min)	G(ref)	E(ref)
KEMET	EIA											
D	7343-31	7.3 ± 0.3	4.3 ± 0.3	2.8 ± 0.3	1.5	2.4	1.3	0.10 ± 0.10	0.13	3.8	3.5	3.5
Y	7343-40	7.3 ± 0.3	4.3 ± 0.3	4.0 max	1.9	2.4	1.3	0.10 ± 0.10	0.13	3.8	3.5	3.5
X	7343-43	7.3 ± 0.3	4.3 ± 0.3	4.0 ± 0.3	2.3	2.4	1.3	0.10 ± 0.10	0.13	3.8	3.5	3.5

T530 RATINGS & PART NUMBER REFERENCE

Capacitance μF	Case Size	KEMET Part Number	DCL V _R	DF % 120Hz	ESR mΩ @100 kHz 25°C Max	Ripple Current (Arms) @ 100 kHz	
						w/ΔT= 20°C @ -55°C to 105°C	w/ΔT= 2°C @ 125°C
2.5 Volt Rating at 105°C (1.7 Volt Rating at 125°C)							
470.0	D	T530D477M2R5A(1)E005	118μA	8.0	5.0	7.1	2.3
470.0	D	T530D477M2R5A(1)E006	118μA	8.0	6.0	6.5	2.1
470.0	D	T530D477M2R5A(1)E010	118μA	10.0	10.0	5.0	1.6
560.0	D	T530D567M2R5A(1)E005	140μA	8.0	5.0	7.1	2.3
680.0	Y	T530Y687M2R5A(1)E005	170μA	8.0	5.0	7.2	2.3
680.0	Y	T530Y687M2R5A(1)E006	170μA	8.0	6.0	6.6	2.1
680.0	D	T530D687M2R5A(1)E006	170μA	8.0	6.0	6.5	2.1
680.0	D	T530D687M2R5A(1)E010	170μA	8.0	10.0	5.0	1.6
680.0	X	T530X687M2R5A(1)E006	170μA	8.0	6.0	6.7	2.1
1000.0	Y	T530Y108M2R5A(1)E005	250μA	8.0	5.0	7.2	2.3
1000.0	Y	T530Y108M2R5A(1)E006	250μA	8.0	6.0	6.6	2.1
1000.0	X	T530X108M2R5A(1)E004	250μA	8.0	4.0	8.2	2.6
1000.0	X	T530X108M2R5A(1)E005	250μA	8.0	5.0	7.3	2.3
1000.0	X	T530X108M2R5A(1)E006	250μA	8.0	6.0	6.7	2.1
1500.0	X	T530X158M2R5A(1)E005	375μA	8.0	5.0	7.3	2.3
3 Volt Rating at 105°C (2 Volt Rating at 125°C)							
470.0	D	T530D477M003A(1)E010	141μA	8.0	10.0	5.0	1.6
680.0	D	T530D687M003A(1)E010	204μA	8.0	10.0	5.0	1.6
1000.0	X	T530X108M003A(1)E010	300μA	8.0	10.0	5.2	1.6
1500.0	X	T530X158M003A(1)E008	450μA	8.0	8.0	5.8	1.8
4 Volt Rating at 105°C (2.7 Volt Rating at 125°C)							
330.0	D	T530D337M004A(1)E005	132μA	8.0	5.0	7.1	2.3
330.0	D	T530D337M004A(1)E006	132μA	8.0	6.0	6.5	2.1
470.0	D	T530D477M004A(1)E006	188μA	8.0	6.0	6.5	2.1
470.0	D	T530D477M004A(1)E010	188μA	8.0	10.0	5.0	1.6
470.0	Y	T530Y477M004A(1)E005	188μA	8.0	5.0	7.2	2.3
470.0	Y	T530Y477M004A(1)E006	188μA	8.0	6.0	6.6	2.1
680.0	Y	T530Y687M004A(1)E005	272μA	8.0	5.0	7.2	2.3
680.0	X	T530X687M004A(1)E004	272μA	8.0	4.0	8.2	2.6
680.0	X	T530X687M004A(1)E005	272μA	8.0	5.0	7.3	2.3
680.0	X	T530X687M004A(1)E006	272μA	8.0	6.0	6.7	2.1
680.0	X	T530X687M004A(1)E010	272μA	8.0	10.0	5.2	1.6
1000.0	X	T530X108M004A(1)E006	400μA	8.0	6.0	6.7	2.1
6.3 Volt Rating at 105°C (4.2 Volt Rating at 125°C)							
220.0	D	T530D227M006A(1)E005	139μA	8.0	5.0	7.1	2.3
220.0	D	T530D227M006A(1)E006	139μA	8.0	6.0	6.5	2.1
330.0	D	T530D337M006A(1)E006	208μA	8.0	6.0	6.5	2.1
330.0	D	T530D337M006A(1)E010	208μA	8.0	10.0	5.0	1.6
330.0	Y	T530Y337M006A(1)E005	208μA	8.0	5.0	7.2	2.3
330.0	Y	T530Y337M006A(1)E006	208μA	8.0	6.0	6.6	2.1
330.0	Y	T530Y337M006A(1)E010	208μA	8.0	10.0	5.1	1.6
470.0	Y	T530Y477M006A(1)E005	296μA	8.0	5.0	7.2	2.3
470.0	X	T530X477M006A(1)E004	296μA	8.0	4.0	8.2	2.6
470.0	X	T530X477M006A(1)E005	296μA	8.0	5.0	7.3	2.3
470.0	X	T530X477M006A(1)E006	296μA	8.0	6.0	6.7	2.1
470.0	X	T530X477M006A(1)E010	296μA	8.0	10.0	5.2	1.6
680.0	X	T530X687M006A(1)E010	428μA	8.0	10.0	5.2	1.6
680.0	X	T530X687M006A(1)E018	428μA	8.0	18.0	3.8	1.2
10 Volt Rating at 105°C (6.6 Volt Rating at 125°C)							
150.0	D	T530D157M010A(1)E005	150μA	8.0	5.0	7.1	2.3
150.0	D	T530D157M010A(1)E006	150μA	8.0	6.0	6.5	2.1
150.0	D	T530D157M010A(1)E010	150μA	8.0	10.0	5.0	1.6
220.0	D	T530D227M010A(1)E006	220μA	8.0	6.0	6.5	2.1
220.0	D	T530D227M010A(1)E010	220μA	8.0	10.0	5.0	1.6
220.0	Y	T530Y227M010A(1)E006	220μA	8.0	6.0	6.6	2.1
330.0	X	T530X337M010A(1)E004	330μA	8.0	4.0	8.2	2.6
330.0	X	T530X337M010A(1)E005	330μA	8.0	5.0	7.3	2.3
330.0	X	T530X337M010A(1)E006	330μA	8.0	6.0	6.7	2.1
330.0	X	T530X337M010A(1)E010	330μA	8.0	10.0	5.2	1.6
16 Volt Rating at 105°C (10.6 Volt Rating at 125°C)							
150.0	X	T530X157M016A(1)E015	240μA	8.0	15.0	4.2	1.3
150.0	X	T530X157M016A(1)E025	240μA	8.0	25.0	3.3	1.0
150.0	X	T530X157M016A(1)E040	240μA	8.0	40.0	2.6	0.8

(1) To complete KEMET Part Number, insert lead material designation from ordering information on page 57. Higher voltage ratings and tighter tolerance product may be substituted within the same size at KEMET's option. Voltage substitutions will be marked with the higher voltage rating.

CONDUCTIVE POLYMER CHIP CAPACITORS **KEMET**

T530 SERIES - High Capacitance/Ultra-Low ESR **CHARGED™**

T530 ORDERING INFORMATION

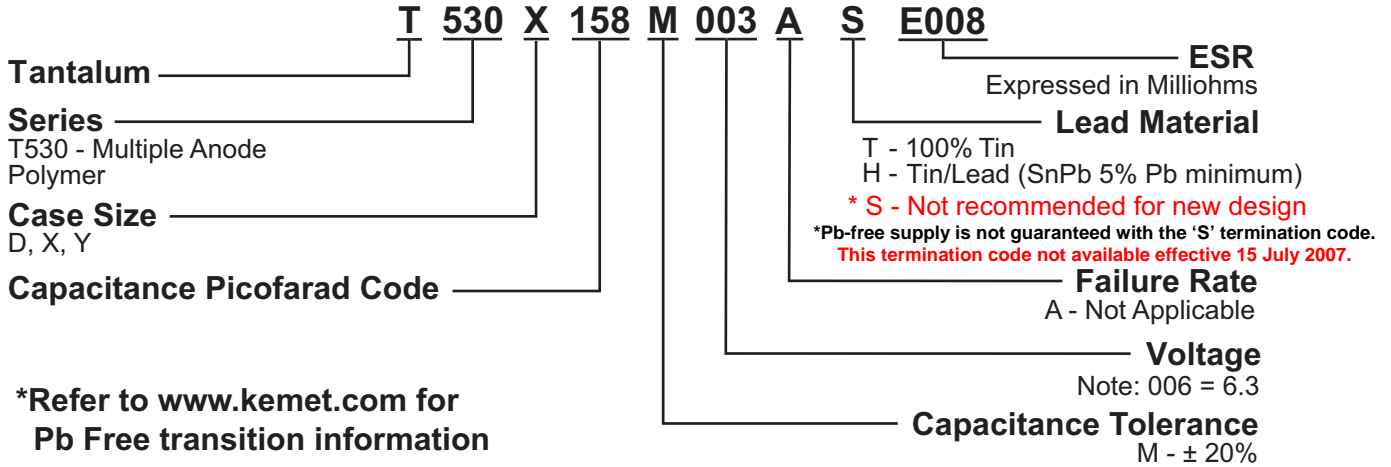

COMPONENT MARKING

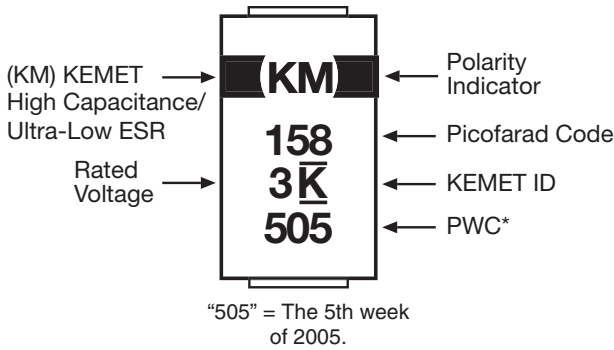

T530 SERIES CONSTRUCTION

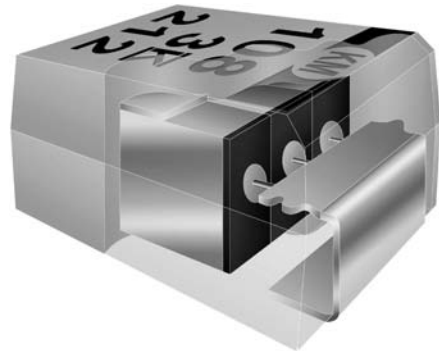

T530X/T510E/T491E 1,000µF Capacitance vs. Frequency

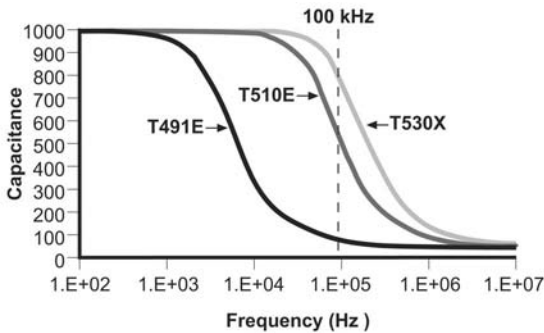

T530X/T510E/T491E 1,000µF Impedance & ESR vs. Frequency

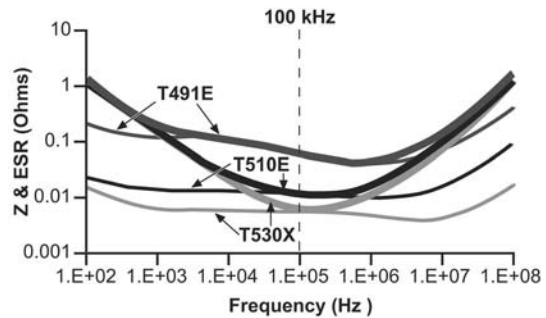

RECOMMENDED TEMPERATURE/VOLTAGE DERATING

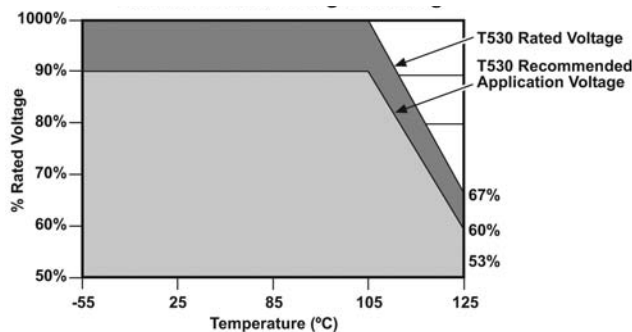

KEMET ALUMINUM ORGANIC CAPACITORS

CHARGED™

Performance Characteristics

Introduction

KEMET entered the world of aluminum capacitors with the introduction of the AO-CAP, designated the A700 Series, which has been targeted for power management applications. The structure of the AO-CAP uses aluminum as the anode material, aluminum oxide as the dielectric, and a conductive organic polymer for its counter-electrode material. The A700 series is 100% screened for all electrical parameters: Capacitance @ 120Hz, Dissipation Factor (DF) @ 120 Hz, ESR @ 100 kHz, and DC Leakage.

The AO-CAP offers many advantages including extremely low ESR, high capacitance retention at high operating frequencies, no dry-out related failure mechanism and no voltage de-rating up to 125°C.

ELECTRICAL

1. Operating Temperature Range

- -55°C to +125°C

No derating with temperature is required.

2. Non-Operating Temperature Range

- -55°C to 125°C

3. Capacitance and Tolerance

- 22µF to 470µF
- ±20% Tolerance

Capacitance is measured at 120 Hz, up to 1.0 volt rms maximum and up to 2.5V DC maximum. DC bias causes only a small reduction in capacitance, up to about 2% when full rated voltage is applied. DC bias is not commonly used for room temperature measurements but is more commonly used when measuring at temperature extremes.

Capacitance does decrease with increasing frequency, but not nearly as much or as quickly as standard tantalums. Figure 1 compares the frequency induced cap roll-off between the AO-CAP and traditional MnO₂ types. Capacitance also increases with increasing temperature. See Section 12 for temperature coefficients.

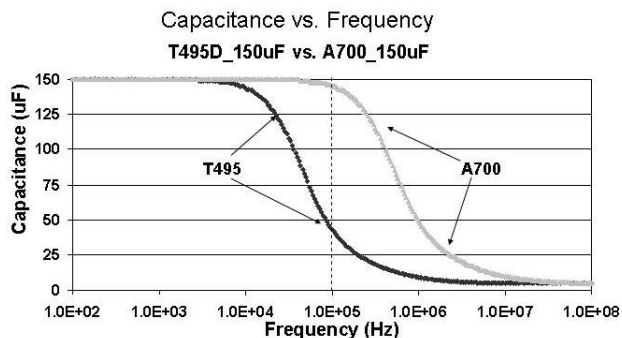

Figure 1.

4. Voltage Ratings

- 2 - 10 VDC Rated Voltage

This is the maximum peak DC operating voltage from -55°C to +125°C for continuous duty.

Surge Voltage Ratings

Surge voltage capability is demonstrated by application of 1000 cycles of the relevant voltage at 25°C, 85°C, or 125 °C. The parts are charged through a 33 ohm resistor for 30 seconds and then discharged through a 33 ohm resistor for 30 seconds for each cycle.

Voltage Ratings • Table 1

Rated Voltage	Surge Voltage
-55°C to 125 °C	
2V	2.6V
2.5V	3.2V
4V	5.2V
6.3V	8V
8V	10.4V
10V	13V

5. Reverse Voltage Rating & Polarity

Aluminum polymer capacitors are polar devices and may be permanently damaged or destroyed if connected in the wrong polarity. The positive terminal is identified by a laser-marked stripe. These capacitors will withstand a certain degree of transient voltage reversal for short periods as shown in the following table. Please note that these parts may not be operated continuously in reverse, even within these limits.

Table 2

Temperature	Permissible Transient Reverse Voltage
25°C	60% of Rated Voltage
55°C	50% of Rated Voltage
85°C	40% of Rated Voltage
125°C	30% of Rated Voltage

6. DC Leakage Current

Because of the high conductivity of the polymer, the AO-CAP family has higher leakage currents than traditional MnO₂ type Tantalum caps. The DC Leakage limits at 25°C are calculated as 0.06 x C x V, (where C is cap in µF and V is rated voltage in Volts) for part types with rated voltage ≤ 4V, and equals 0.04 x C x V, for voltages > 4V. Limits for all part numbers are listed in the ratings tables.

DC Leakage Current is the current that flows through the capacitor dielectric after a five minute charging period at rated voltage. Leakage is measured at 25°C with full rated voltage applied to the capacitor through a 1000 ohm resistor in series with the capacitor.

DC Leakage Current does increase with temperature. The limits for 85°C @ Rated Voltage and 125°C are both 2 times the 25°C limit.

7. Dissipation Factor (DF)

Refer to part number tables for maximum DF limits.

Dissipation factor is measured at 120 Hz, up to 1.0 volt rms maximum. Dissipation factor is the ratio of the equivalent series resistance (ESR) to the capacitive reactance, (X_C) and is usually expressed as a percentage. It is directly proportional to both capacitance and frequency. Dissipation factor loses its importance at higher frequencies, (above about 1 kHz), where impedance (Z) and equivalent series resistance (ESR) are the normal parameters of concern.

$$DF = \frac{R}{X_C} = 2\pi fCR$$

Where:

DF = Dissipation Factor

R = Equivalent Series Resistance (Ohms)

X_C = Capacitive Reactance (Ohms)

f = Frequency (Hertz)

C = Capacitance (Farads)

DF is also referred to as $\tan \delta$ or "loss tangent." The "Quality Factor," "Q", is the reciprocal of DF.

8. Equivalent Series Resistance (ESR) and Impedance (Z)

The Equivalent Series Resistance (ESR) of the AO-CAP is much lower than standard Tantalum caps because the polymer cathode has much higher conductivity. ESR is not a pure resistance, and it decreases with increasing frequency.

Total impedance of the capacitor is the vector sum of capacitive reactance (X_C) and ESR below resonance; above resonance total impedance is the vector sum of inductive reactance (X_L) and ESR.

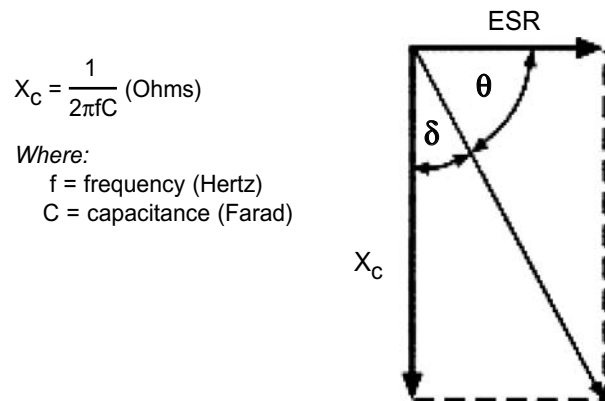

Figure 2a Total Impedance of the Capacitor Below Resonance

$$X_L = 2\pi fL \text{ (Ohms)}$$

Where:

f = frequency (Hertz)

L = inductance (Henries)

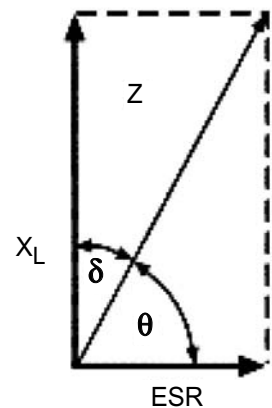

Figure 2b Total Impedance of the Capacitor Above Resonance

To understand the many elements of a capacitor, see Figure 3.

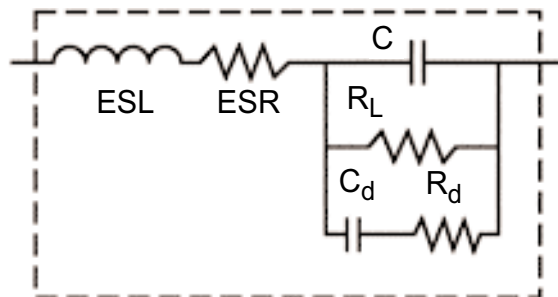

Figure 3 The Real Capacitor

A capacitor has a complex impedance consisting of many series and parallel elements, each adding to the complexity of the measurement system.

ESL - Represents inductance. In most instances it is significant at the basic measurement frequencies of 120 and 1000 Hz.

ESR - Represents the ohmic resistance in series with the capacitance. Lead attachment and capacitor electrodes are contributing sources.

KEMET ALUMINUM ORGANIC CAPACITORS

CHARGED™

Performance Characteristics

R_L - Capacitor Leakage Resistance. Typically it can be 35 K to 2.5 MOhms depending on voltage - capacitance. It can exceed 10¹² ohms in monolithic ceramics and in film capacitors.

R_d - The dielectric loss contributed by dielectric absorption and molecular polarization. It becomes very significant in high frequency measurements and applications. Its value varies with frequency.

C_d - The inherent dielectric absorption of the solid aluminum capacitor.

As frequency increases, X_C continues to decrease according to its equation. There is unavoidable inductance as well as resistance in all capacitors, and at some point in frequency, the reactance ceases to be capacitive and becomes inductive. This frequency is called the self-resonant point.

Figure 4 compares the frequency response of an AO-CAP to a Tantalum chip. Maximum limits for 100 kHz ESR are listed in the part number tables for each series.

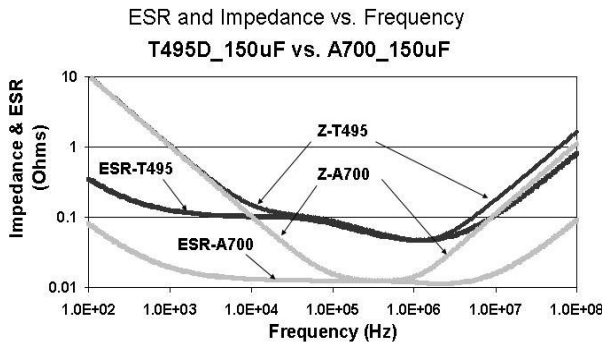

Figure 4.

9. AC Power Dissipation

Power dissipation is a function of capacitor size and materials. Maximum power ratings have been established for all case sizes to prevent overheating. In actual use, the capacitor's ability to dissipate the heat generated at any given power level may be affected by a variety of circuit factors. These include board density, pad size, heat sinks and air circulation.

Power capability is determined based on a 20°C temperature rise. A higher temperature rise and therefore higher power capability is allowable as long as the ambient temperature plus temperature rise due to ripple current does not exceed the rated temperature of the part.

Case Code		Maximum Power Dissipation mWatts @ +25°C with 20° Temperature Rise
KEMET	EIA	
V	7343-20	270
D	7343-31	250
X	7343-43	225

Table 3 - AO Capacitor Power Dissipation Ratings

10. Ripple Current/Voltage

Permissible AC ripple voltage and current are related to equivalent series resistance (ESR) and power dissipation capability.

Permissible ripple current which may be applied is limited by two criteria:

- The resulting voltage across the capacitor with the summation of DC bias and peak voltage of the AC portion must not exceed the rated voltage of the capacitor.
- The negative peak AC voltage, in combination with bias voltage, if any, must not exceed the permissible reverse voltage ratings presented in Section 5.

Actual power dissipated may be calculated from the following:

$$P = I^2R$$

$$\text{Substituting } I = \frac{E}{Z}; \quad P = \frac{E^2R}{Z^2}$$

Where:

- I = rms ripple current (Amperes)
- E = rms ripple voltage (Volts)
- P = power (Watts)
- Z = impedance at specified frequency (ohms)
- R = ESR(Ohms)

Using P_{max} from Table 3, maximum allowable rms ripple current or voltage may be determined as follows:

$$I_{\max} = \sqrt{\frac{P_{\max}}{\text{ESR}}} \quad E_{\max} = Z \sqrt{\frac{P_{\max}}{R}}$$

Where:

- I_{max} = Maximum ripple current (ARMS)
- P_{max} = Maximum Power @ allowable ΔT normally +20°C
- E_{max} = Maximum ripple voltage (VRMS)

Refer to part number listings for permissible Arms limits.

ENVIRONMENTAL

11. Temperature Stability

Mounted capacitors withstand extreme temperature testing at a succession or continuous steps at +25°C, -55°C, +25°C, +85°C, +125°C, +25°C in that order. Capacitors are allowed to stabilize at each temperature before measurement. Cap, DF, and DCL are measured at each temperature; except DC Leakage is not measured at -55°C.

Step	Temp	ΔCap	DCL	DF
1	25°C	Specified Tolerance	Catalog Limit	Catalog Limit
2	-55°C	15% of initial value	N/A	Catalog Limit
3	+25°C	5% of initial value	Catalog Limit	Catalog Limit
4	+85°C	15% of initial value	2X Catalog Limit	Catalog Limit
5	+125°C	20% of initial value	2X Catalog Limit	Catalog Limit
6	+25°C	5% of initial value	Catalog Limit	Catalog Limit

Table 4 - Acceptable limits are as follows:

12. Standard Life Test

- 85°C, Rated Voltage, 2000 Hours

Post Test Performance:

- Capacitance: within ±10% of initial value
- DF: within initial limit
- DC Leakage: within initial limit
- ESR: within initial limit

13. High Temperature Life Test

- 125°C, Rated Voltage, 2000 Hours

Post Test Performance:

- Capacitance: within ±10% of initial value
- DF: within initial limit
- DC Leakage: within 1.25 x initial limit
- ESR: within 2 x initial limit

14. Storage Life Test

- 125°C, 0 VDC, 2000 Hours

Post Test Performance:

- Capacitance: within ±10% of initial value
- DF: within initial limit
- DC Leakage: within 1.25 x initial limit
- ESR: within 2 x initial limit

15. Thermal Shock

- Mil-Std-202, Method 107, Condition B

Minimum temperature is -55°C

Maximum temperature is +125°C

Post Test Performance:

- Capacitance: within ±10% of initial value
- DF: within initial limit
- DC Leakage: within initial limit
- ESR: within 2 x initial limit

16. Moisture Sensitivity Level (MSL)

- J-Std-020

- Capacitance: within ±30% of initial value
- DF: within initial limit
- DC Leakage: within initial limit
- ESR: within 2 x initial limit

Meets MSL 3 requirements for SnPb assembly.

17. Load Humidity

- 85°C, 85% RH, Rated Voltage, 500 Hours

- Capacitance: within +30/-5% of initial value
- DF: within initial limit
- DC Leakage: within 5 x initial limit
- ESR: within 2 x initial limit

18. ESD

- Polymer Aluminum capacitors are not sensitive to Electro-Static Discharge (ESD).

19. Failure Mechanism and Reliability

The normal failure mechanism is dielectric break down. Dielectric failure can result in high DC Leakage current and may proceed to the level of a short circuit. With sufficient time to charge, healing may occur by one of two potential mechanisms. The polymer adjacent to the dielectric fault site may over-heat and vaporize, disconnecting the fault site from the circuit. The polymer may also oxidize into a more resistive material that caps the defect site in the dielectric and reduces the flow of current.

Capacitor failure may be induced by exceeding the rated conditions of forward DC voltage, reverse DC voltage, surge current, power dissipation or temperature. Excessive environmental stress, such as prolonged or high temperature reflow processes may also trigger dielectric failure.

20. Resistance to Solvents

- Mil-Std 202, Method 215

Post Test Performance:

- Capacitance: within ±10% of initial value
- DF: within initial limit
- DC Leakage: within initial limit
- ESR: within initial limit
- Physical: no degradation of case, terminals or marking

21. Fungus

- Mil-Std-810, Method 508

22. Flammability

- UL94 VO Classification

KEMET ALUMINUM ORGANIC CAPACITORS

CHARGED.[®] Performance Characteristics

23. Resistance to Soldering Heat

- **Maximum Reflow**
+245 ±5°C, 10 seconds
- **Typical Reflow**
+230 ±5°C, 30 seconds

Post Test Performance:

- Capacitance: within ±10% of initial value
- DF: within initial limit
- DC Leakage: within initial limit
- ESR: within initial limit

24. Solderability

- **Mil-Std-202, Method 208**
- **ANSI/J-Std-002, Test B**

25. Vibration

- **Mil-Std-202, Method 204, Condition D, 10 Hz to 2,000 Hz, 20G Peak**

Post Test Performance:

- Capacitance: within ±10% of initial value
- DF: within initial limit
- DC Leakage: within initial limit
- ESR: within initial limit

26. Shock

- **Mil-Std-202, Method 213, Condition I, 100 G Peak**

Post Test Performance:

- Capacitance: within ±10% of initial value
- DF: within initial limit
- DC Leakage: within initial limit
- ESR: within initial limit

27. Terminal Strength

- **Pull Force**
- **One Pound (454 grams), 30 Seconds**

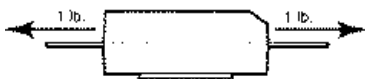

- **Tensile Force**
- **Four Pounds (1.8 kilograms), 60 Seconds**

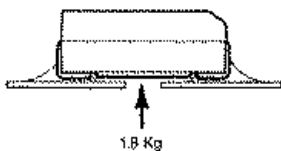

- **Shear Force**

Table 5 Maximum Shear Loads

Case Code		Maximum Shear Loads	
KEMET	EIA	Kilograms	Pounds
V	7343-20	5.0	11.0
D	7343-31	5.0	11.0
X	7343-43	5.0	11.0

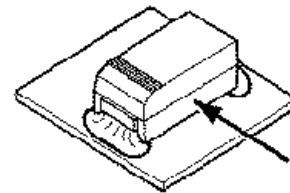

Post Test Performance:

- Capacitance: within ±5% of initial value
- DF: within initial limit
- DC Leakage: within initial limit
- ESR within initial limit

28. Handling

Automatic handling of encapsulated components is enhanced by the molded case which provides compatibility with all types of high speed pick and place equipment. Manual handling of these devices presents no unique problems. Care should be taken with your fingers, however, to avoid touching the solder-coated terminations as body oils, acids and salts will degrade the solderability of these terminations. Finger cots should be used whenever manually handling all solderable surfaces.

29. Termination Coating

The standard finish coating is 100% Sn solder (Tin-solder coated) with nickel (Ni) underplating.

30. Recommended Mounting Pad Geometries

Proper mounting pad geometries are essential for successful solder connections. These dimensions are highly process sensitive and should be designed to maximize the integrity of the solder joint, and to minimize component rework due to unacceptable solder joints.

Figure 5 illustrates pad geometry. The table provides recommended pad dimensions for reflow soldering techniques. These dimensions are intended to be a starting point for circuit board designers, to be fine tuned, if necessary, based upon the peculiarities of the soldering process and/or circuit board design.

Contact KEMET for Engineering Bulletin Number F-2100 entitled "Surface Mount Mounting Pad Dimensions and Considerations" for further details on this subject or visit our website at www.kemet.com.

Figure 5

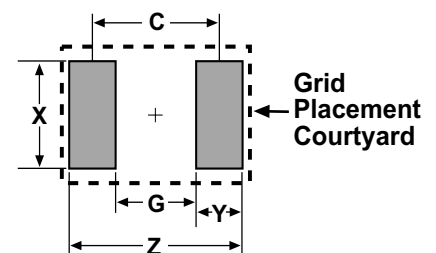

ALUMINUM ORGANIC CAPACITORS

Performance Characteristics



KEMET/EIA Size Code	Pad Dimensions				
	Z	G	X	Y (Ref)	C (Ref)
D/7343-31, V/7343-20 X/7343-43	8.90	3.80	2.70	2.55	6.35

Table 6 - Land Pattern Dimensions for Reflow Solder

31. Soldering

The A700 - AO-CAP family has been designed for reflow solder processes, or for wave soldering. The solder-coated terminations have excellent wetting characteristics for high integrity solder fillets. Preheating of these components is recommended to avoid extreme thermal stress. Figure 6 represents the recommended maximum solder temperature/time combinations for these devices.

Hand-soldering should be avoided. However, if necessary it should be performed with care due to the difficulty in process control. Care should be taken to avoid contact of the soldering iron to the molded case. The iron should be used to heat the solder pad, applying solder between the pad and the termination, until reflow occurs. The iron should be removed. "Wiping" the edges of a chip and heating the top surface is not recommended.

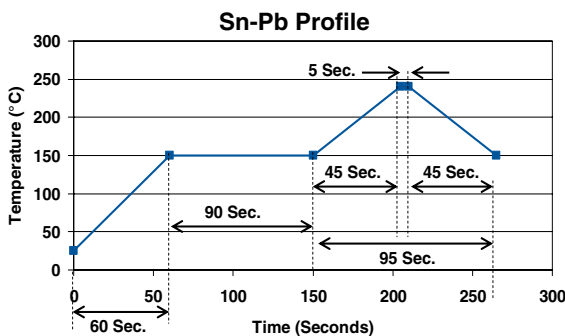

Figure 6 Sn-Pb Profile measured on the surface of the component

* Contact KEMET for the latest A700 Pb-free soldering recommendations.

32. Washing

Standard washing techniques and solvents are compatible with all KEMET surface mount aluminum capacitors. Solvents such as Freon TMC and TMS, Trichlorethane, methylene chloride, prelate, and isopropyl alcohol are not harmful to these components. Please note that we are not endorsing the use of banned or restricted solvents. We are simply stating that they would not be harmful to the components.

If ultrasonic agitation is utilized in the cleaning process, care should be taken to minimize energy levels and exposure times to avoid damage to the terminations.

KEMET AO-CAPS are also compatible with newer aqueous and semi-aqueous processes.

33. Encapsulations

Under normal circumstances, potting or encapsulation of KEMET aluminum chips is not required.

34. Storage Environment

AO capacitors are shipped in moisture barrier bags with a desiccant and moisture indicator card. This series is classified as MSL3 (Moisture Sensitivity Level 3). Upon opening the moisture barrier bag, parts should be mounted within 7 days to prevent moisture absorption and outgassing. If the 7 day window is exceeded, the parts can be dried per the instructions on the bag (168 hours at 40 ± 5°C).

AO capacitors should be stored in normal working environments. While the chips themselves are quite robust in other environments, solderability will be degraded by exposure to high temperatures, high humidity, corrosive atmospheres, and long term storage. In addition, packaging materials will be degraded by high temperature (reels may soften or warp, and tape peel force may increase). KEMET recommends that maximum storage temperature not exceed 40 degrees C, and the maximum storage humidity not to exceed 60% relative humidity. In addition, temperature fluctuations should be minimized to avoid condensation on the parts, and atmospheres should be free of chlorine and sulfur bearing compounds. For optimized solderability, chip stock should be used promptly, preferably within 1.5 years of receipt.

Tape & Reel Packaging

Case Codes		Tape & Reel Dimensions				
KEMET	EIA	Tape Width mm	Pitch mm ± 0.1		Reel Quantity	
			Part	Sprocket	180mm (7" dia.)	330mm (13" dia.)
V	7343-20	12 ± 0.3	8	4	1000	3000
D	7343-31	12 ± 0.3	8	4	500	2500
X	7343-43	12 ± 0.3	8	4	500	2000

Component Marking

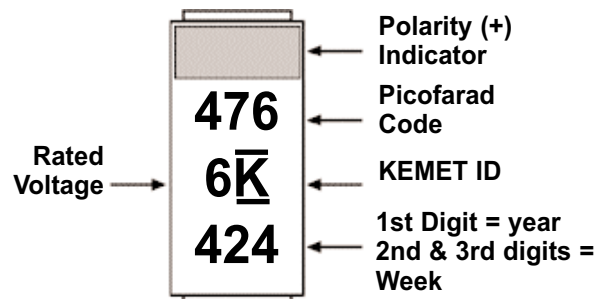

Aluminum Component Weights

Series	Case Size	Typical Weight (mg)
A700	V/7343-20	120
A700	D/7343-31	190
A700	X/7343-43	260

KEMET ALUMINUM ORGANIC CAPACITORS

CHARGED™

A700 Series

APPLICATIONS

- Input/Output Filters for voltage regulators, converters, and SMPS
- Battery Decoupling (portable, handheld electronics)
- Power Decoupling (Processor, Transmitter circuits)
- Bulk Capacitor Requirements

FEATURES

- Polymer Cathode Technology
- Extremely Low ESR
- High Frequency Capacitance Retention
- Non-ignition Failure Mode
- Capacitance: 22 to 470 μF
- Self-healing Mechanism
- -55° to +125°C Capability
- No temperature voltage Derating Up To 125°C
- Robust to Surface Mount Process
- 100% Accelerated Steady State Aging
- Pb Free and RoHS Compliant
- Solid-state Technology
- Molded Case with Wraparound Termination
- Voltage: 2 to 10V
- No Reformation Required
- EIA Standard Case Size
- No Dry-out Related Failure Mechanism

OUTLINE DRAWING

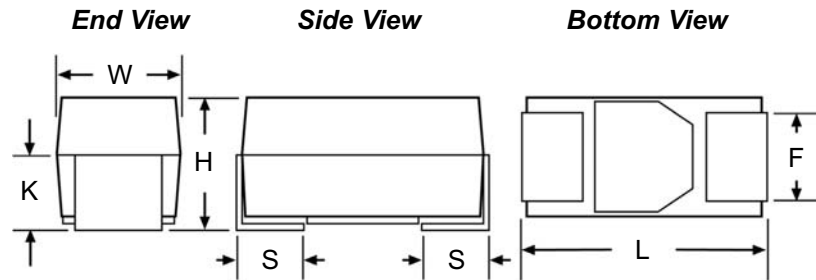

DIMENSIONS - MILLIMETERS

Case Size		L	W	H	K Min.	F ± 0.1	S ± 0.2
KEMET	EIA						
V	7343-20	7.3 \pm 0.3	4.3 \pm 0.3	1.9 \pm 0.1	0.9	2.4	1.3
D	7343-31	7.3 \pm 0.3	4.3 \pm 0.3	2.8 \pm 0.3	1.3	2.4	1.3
X	7343-43	7.3 \pm 0.3	4.3 \pm 0.3	4.0 \pm 0.3	2.1	2.4	1.3

Note that glue pad shape may differ at KEMET's discretion.

A700 ORDERING INFORMATION

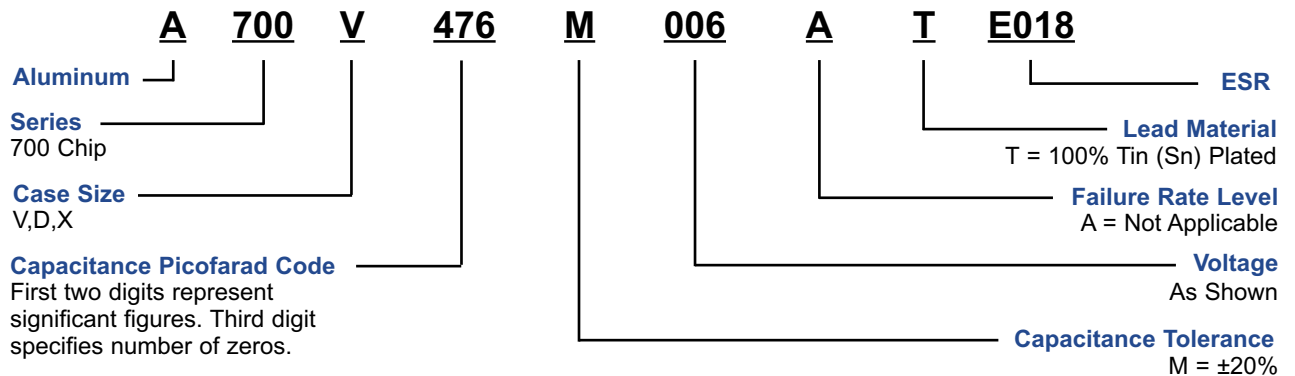

ALUMINUM ORGANIC CAPACITORS

A700 Series



A700 RATINGS & PART NUMBER REFERENCE

KEMET Part Number	Case Size	Cap µF	DCL @V _R	DF @ 120 Hz	ESR 100 kHz (mΩ)	Ripple Current (Arms) @ 100kHz w/ΔT=+20°C @ -55°C to 125°C
2 Volt Rating @ 125°C						
A700V107M002ATE018	V/7343-20	100.0	12.0 µA	6%	18	3.9
A700V107M002ATE025	V/7343-20	100.0	12.0 µA	6%	25	3.3
A700V107M002ATE028	V/7343-20	100.0	12.0 µA	6%	28	3.1
A700V127M002ATE018	V/7343-20	120.0	14.4 µA	6%	18	3.9
A700V127M002ATE025	V/7343-20	120.0	14.4 µA	6%	25	3.3
A700V127M002ATE028	V/7343-20	120.0	14.4 µA	6%	28	3.1
A700V157M002ATE009	V/7343-20	150.0	18.0 µA	6%	9	5.4
A700V157M002ATE018	V/7343-20	150.0	18.0 µA	6%	18	3.9
A700V157M002ATE025	V/7343-20	150.0	18.0 µA	6%	25	3.3
A700V157M002ATE028	V/7343-20	150.0	18.0 µA	6%	28	3.1
A700D187M002ATE015	D/7343-31	180.0	21.6 µA	6%	15	4.1
A700D187M002ATE018	D/7343-31	180.0	21.6 µA	6%	18	3.7
A700V227M002ATE009	V/7343-20	220.0	26.4 µA	6%	9	5.5
A700D227M002ATE015	D/7343-31	220.0	26.4 µA	6%	15	4.1
A700D227M002ATE018	D/7343-31	220.0	26.4 µA	6%	18	3.7
A700X277M002ATE010	X/7343-43	270.0	32.4 µA	6%	10	4.7
A700X277M002ATE012	X/7343-43	270.0	32.4 µA	6%	12	4.3
A700X277M002ATE015	X/7343-43	270.0	32.4 µA	6%	15	3.9
A700D337M002ATE007	D/7343-31	330.0	39.6 µA	6%	7	6.0
A700X337M002ATE010	X/7343-43	330.0	39.6 µA	6%	10	4.7
A700X337M002ATE015	X/7343-43	330.0	39.6 µA	6%	15	3.9
A700X397M002ATE010	X/7343-43	390.0	46.8 µA	6%	10	4.7
A700X397M002ATE015	X/7343-43	390.0	46.8 µA	6%	15	3.9
A700X477M002ATE010	X/7343-43	470.0	56.4 µA	6%	10	4.7
A700X477M002ATE015	X/7343-43	470.0	56.4 µA	6%	15	3.9
2.5 Volt Rating @ 125°C						
A700V826M2R5ATE018	V/7343-20	82.0	12.3 µA	6%	18	3.9
A700V826M2R5ATE025	V/7343-20	82.0	12.3 µA	6%	25	3.3
A700V826M2R5ATE028	V/7343-20	82.0	12.3 µA	6%	28	3.1
A700D157M2R5ATE015	D/7343-31	150.0	22.5 µA	6%	15	4.1
A700D157M2R5ATE018	D/7343-31	150.0	22.5 µA	6%	18	3.7
A700D187M2R5ATE015	D/7343-31	180.0	27.0 µA	6%	15	4.1
A700D187M2R5ATE018	D/7343-31	180.0	27.0 µA	6%	18	3.7
A700X227M2R5ATE010	X/7343-43	220.0	33.0 µA	6%	10	4.7
A700X227M2R5ATE015	X/7343-43	220.0	33.0 µA	6%	15	3.9
A700X337M2R5ATE010	X/7343-43	330.0	49.5 µA	6%	10	4.7
A700X337M2R5ATE015	X/7343-43	330.0	49.5 µA	6%	15	3.9
4 Volt Rating @ 125°C						
A700V826M004ATE018	V/7343-20	82.0	19.7 µA	6%	18	3.9
A700V826M004ATE025	V/7343-20	82.0	19.7 µA	6%	25	3.3
A700V826M004ATE028	V/7343-20	82.0	19.7 µA	6%	28	3.1
A700D127M004ATE015	D/7343-31	120.0	28.8 µA	6%	15	4.1
A700D127M004ATE018	D/7343-31	120.0	28.8 µA	6%	18	3.7
A700D157M004ATE015	D/7343-31	150.0	36.0 µA	6%	15	4.1
A700D157M004ATE018	D/7343-31	150.0	36.0 µA	6%	18	3.7
A700D187M004ATE015	D/7343-31	180.0	43.2 µA	6%	15	4.1
A700D187M004ATE018	D/7343-31	180.0	43.2 µA	6%	18	3.7
A700X187M004ATE010	X/7343-43	180.0	43.2 µA	6%	10	4.7
A700X187M004ATE015	X/7343-43	180.0	43.2 µA	6%	15	3.9
A700D227M004ATE009	X/7343-43	220.0	52.8 µA	6%	9	5.3
A700X227M004ATE009	X/7343-43	220.0	52.8 µA	6%	9	5.3
A700X227M004ATE010	X/7343-43	220.0	52.8 µA	6%	10	4.7
A700X227M004ATE015	X/7343-43	220.0	52.8 µA	6%	15	3.9
A700X277M004ATE010	X/7343-43	270.0	64.8 µA	6%	10	4.7
A700X277M004ATE015	X/7343-43	270.0	64.8 µA	6%	15	3.9
A700X337M004ATE010	X/7343-43	330.0	79.2 µA	6%	10	4.7
A700X337M004ATE015	X/7343-43	330.0	79.2 µA	6%	15	3.9

A700 RATINGS & PART NUMBER REFERENCE

KEMET Part Number	Case Size	Cap µF	DCL @V _R	DF @ 120 Hz	ESR 100 kHz (mΩ)	Ripple Current (Arms) @ 100kHz w/ΔT=+20°C @ -55°C to 125°C
6.3 Volt Rating @ 125°C						
A700V226M006ATE028	V/7343-20	22.0	5.5 µA	6%	28	3.1
A700V226M006ATE045	V/7343-20	22.0	5.5 µA	6%	45	2.4
A700V336M006ATE018	V/7343-20	33.0	8.3 µA	6%	18	3.9
A700V336M006ATE025	V/7343-20	33.0	8.3 µA	6%	25	3.3
A700V336M006ATE028	V/7343-20	33.0	8.3 µA	6%	28	3.1
A700V476M006ATE018	V/7343-20	47.0	11.8 µA	6%	18	3.9
A700V476M006ATE025	V/7343-20	47.0	11.8 µA	6%	25	3.3
A700V476M006ATE028	V/7343-20	47.0	11.8 µA	6%	28	3.1
A700V566M006ATE018	V/7343-20	56.0	14.1 µA	6%	18	3.9
A700V566M006ATE025	V/7343-20	56.0	14.1 µA	6%	25	3.3
A700V566M006ATE028	V/7343-20	56.0	14.1 µA	6%	28	3.1
A700V686M006ATE018	V/7343-20	68.0	17.1 µA	6%	18	3.9
A700V686M006ATE025	V/7343-20	68.0	17.1 µA	6%	25	3.3
A700V686M006ATE028	V/7343-20	68.0	17.1 µA	6%	28	3.1
A700V826M006ATE018	V/7343-20	82.0	20.7 µA	6%	18	3.9
A700V826M006ATE025	V/7343-20	82.0	20.7 µA	6%	25	3.3
A700V826M006ATE028	V/7343-20	82.0	20.7 µA	6%	28	3.1
A700D107M006ATE015	D/7343-31	100.0	25.2 µA	6%	15	4.1
A700D107M006ATE018	D/7343-31	100.0	25.2 µA	6%	18	3.7
A700D127M006ATE012	D/7343-31	120.0	30.2 µA	6%	12	4.6
A700D127M006ATE015	D/7343-31	120.0	30.2 µA	6%	15	4.1
A700D127M006ATE018	D/7343-31	120.0	30.2 µA	6%	18	3.7
A700X157M006ATE010	X/7343-43	150.0	37.8 µA	6%	10	4.7
A700X157M006ATE012	X/7343-43	150.0	37.8 µA	6%	12	4.3
A700X157M006ATE015	X/7343-43	150.0	37.8 µA	6%	15	3.9
A700X187M006ATE010	X/7343-43	180.0	45.4 µA	6%	10	4.7
A700X187M006ATE015	X/7343-43	180.0	45.4 µA	6%	15	3.9
A700X227M006ATE015	X/7343-43	220.0	55.4 µA	6%	15	3.9
8 Volt Rating @ 125°C						
A700V226M008ATE028	V/7343-20	22.0	7.0 µA	6%	28	3.1
A700V226M008ATE045	V/7343-20	22.0	7.0 µA	6%	45	2.4
A700V336M008ATE018	V/7343-20	33.0	10.6 µA	6%	18	3.9
A700V336M008ATE025	V/7343-20	33.0	10.6 µA	6%	25	3.3
A700V336M008ATE028	V/7343-20	33.0	10.6 µA	6%	28	3.1
A700D566M008ATE015	D/7343-31	56.0	17.9 µA	6%	15	4.1
A700D566M008ATE018	D/7343-31	56.0	17.9 µA	6%	18	3.7
A700D686M008ATE015	D/7343-31	68.0	21.8 µA	6%	15	4.1
A700D686M008ATE018	D/7343-31	68.0	21.8 µA	6%	18	3.7
A700X107M008ATE010	X/7343-43	100.0	32.0 µA	6%	10	4.7
A700X107M008ATE012	X/7343-43	100.0	32.0 µA	6%	12	4.3
A700X107M008ATE015	X/7343-43	100.0	32.0 µA	6%	15	3.9
10 Volt Rating @ 125°C						
A700V226M010ATE028	V/7343-20	22.0	8.8 µA	6%	28	3.1
A700V336M010ATE018	V/7343-20	33.0	13.2 µA	6%	18	3.9
A700V336M010ATE025	V/7343-20	33.0	13.2 µA	6%	25	3.3
A700V336M010ATE028	V/7343-20	33.0	13.2 µA	6%	28	3.1
A700D566M010ATE015	D/7343-31	56.0	22.4 µA	6%	15	4.1
A700D566M010ATE018	D/7343-31	56.0	22.4 µA	6%	18	3.7
A700D686M010ATE015	D/7343-31	68.0	27.2 µA	6%	15	4.1
A700D686M010ATE018	D/7343-31	68.0	27.2 µA	6%	18	3.7
A700X107M010ATE010	X/7343-43	100.0	40.0 µA	6%	10	4.7
A700X107M010ATE015	X/7343-43	100.0	40.0 µA	6%	15	3.9
A700X127M010ATE010	X/7343-43	120.0	48.0 µA	6%	10	4.7
A700X127M010ATE015	X/7343-43	120.0	48.0 µA	6%	15	3.9
A700X157M010ATE010	X/7343-43	150.0	60.0 µA	6%	10	4.7
A700X157M010ATE015	X/7343-43	150.0	60.0 µA	6%	15	3.9
12.5 Volt Rating @ 125°C						
A700V106M12RATE060	V/7343-20	10.0	5.0 µA	6%	60	2.1
A700V156M12RATE040	V/7343-20	15.0	7.5 µA	6%	40	2.6
A700V226M12RATE030	V/7343-20	22.0	11.0 µA	6%	30	3.0
16 Volt Rating @ 125°C						
A700V685M016ATE070	V/7343-20	6.8	4.3 µA	6%	70	1.9
A700V825M016ATE070	V/7343-20	8.2	5.2 µA	6%	70	2.4

INTRODUCTION

Ceramic chips consist of formulated ceramic dielectric materials which have been fabricated into thin layers, interspersed with metal electrodes alternately exposed on opposite edges of the laminated structure. The entire structure is then fired at high temperature to produce a monolithic block which provides high capacitance values in a small physical volume. After firing, conductive terminations are applied to opposite ends of the chip to make contact with the exposed electrodes. Standard end terminations use a nickel barrier layer and a tin overplate to provide excellent solderability for the customer.

KEMET multilayer ceramic chip capacitors are produced in plants designed specifically for chip capacitor manufacture. The process features a high degree of mechanization as well as precise controls over raw materials and process conditions. Manufacturing is supplemented by extensive Technology, Engineering and Quality Assurance programs.

KEMET ceramic chip capacitors are offered in the five most popular temperature characteristics. These are designated by the Electronics Industries Association (EIA) as the ultra-stable C0G (also known as NP0, military version BP), the stable X7R (military BX or BR), the stable X5R, and the general purpose Z5U and Y5V. A wide range of sizes are available. KEMET multilayer ceramic chip capacitors are available in KEMET's tape and reel packaging, compatible with automatic placement equipment. Bulk cassette packaging is also available (0805,0603 and 0402 only) for those pick and place machines requiring its use.

ELECTRICAL CHARACTERISTICS

1. Working Voltage:

Refers to the maximum continuous DC working voltage permissible across the entire operating temperature range. The reliability of multilayer ceramic capacitors is not extremely sensitive to voltage, and brief applications of voltage above rated will not result in immediate failure. However, reliability will be degraded by sustained exposure to voltages above rated.

2. Temperature Characteristics:

Within the EIA classifications, various temperature characteristics are identified by a three-symbol code; for example: C0G, X7R, X5R, Z5U and Y5V.

For Class I temperature compensating dielectrics (includes C0G), the first symbol designates the significant figures of the temperature coefficient in PPM per degree Celsius, the second designates the multiplier to be applied, and the third designates the tolerance in PPM per degrees Celsius. EIA temperature characteristic codes for Class I dielectrics are shown in Table 1.

Table 1 – EIA Temperature Characteristic Codes for Class I Dielectrics

Significant Figure of Temperature Coefficient		Multiplier Applied to Temperature Coefficient		Tolerance of Temperature Coefficient	
PPM per Degree C	Letter Symbol	Multiplier	Number Symbol	PPM per Degree C	Letter Symbol
0.0	C	-1	0	± 30	G
0.3	B	-10	1	± 60	H
0.9	A	-100	2	± 120	J
1.0	M	-1000	3	± 250	K
1.5	P	-10000	4	± 500	L

KEMET supplies the C0G characteristic.

For Class II and III dielectrics (including X7R, X5R, Z5U & Y5V), the first symbol indicates the lower limit of the operating temperature range, the second indicates the upper limit of the operating temperature range, and the third indicates the maximum capacitance change allowed over the operating temperature range. EIA type designation codes for Class II and III dielectrics are shown in Table 2.

Table 2 – EIA Temperature Characteristic Codes for Class II & III Dielectrics

Low Temperature Rating		High Temperature Rating		Maximum Capacitance Shift		
Degree Celsius	Letter Symbol	Degree Celsius	Number Symbol	Percent	Letter Symbol	EIA Class
+10C	Z	+45C	2	± 1.0%	A	II
-30C	Y	+65C	4	± 1.5%	B	II
-55C	X	+85C	5	± 2.2%	C	II
		+105C	6	± 3.3%	D	II
		+125C	7	± 4.7%	E	II
		+150C	8	± 7.5%	F	II
		+200C	9	± 10.0%	P	II
				± 15.0%	R	II
				± 22.0%	S	III
				+ 22/-33%	T	III
				+22/-56%	U	III
				+22/-82%	V	III

KEMET supplies the X7R, X5R, Z5U and Y5V characteristics.

3. Capacitance Tolerance:

See tables on pages 73-76.

4. Capacitance:

Within specified tolerance when measured per Table 3.

The standard unit of capacitance is the farad. For practical capacitors, capacitance is usually expressed in microfarads (10^{-6} farad), nanofarads (10^{-9} farad), or picofarads (10^{-12} farad). Standard measurement conditions are listed in Table 3 - Specified Electrical Limits.

Like all other practical capacitors, multilayer ceramic capacitors also have resistance and inductance. A simplified schematic for the single frequency equivalent circuit is shown in Figure 1. At high frequency more complex models apply - see KEMET SPICE models at www.kemet.com for details.

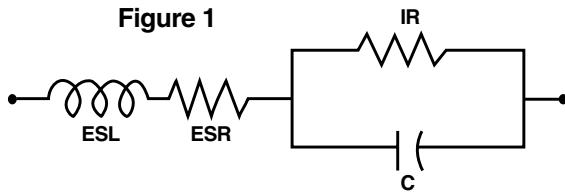

C = Capacitance
ESL = Equivalent Series Inductance
ESR = Equivalent Series Resistance
IR = Insulation Resistance

5. Dissipation Factor:
Measured under same conditions as capacitance. (See Table 3)

Dissipation factor (DF) is a measure of the losses in a capacitor under AC application. It is the ratio of the equivalent series resistance to the capacitive reactance, and is usually expressed in percent. It is normally measured simultaneously with capacitance, and under the same conditions. The vector diagram below illustrates the relationship between DF, ESR and impedance. The reciprocal of the dissipation factor is called the “Q” or quality factor. For convenience, the “Q” factor is often used for very low values of dissipation factor especially when measured at high frequencies. DF is sometimes called the “loss tangent” or “tangent δ”, as shown in Figure 2.

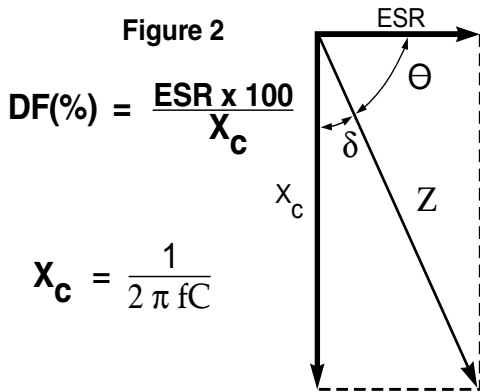

6. Impedance:

Since the parallel resistance (IR) is normally very high, the total impedance of the capacitor can be approximated by:

Figure 3

$$Z = \sqrt{ESR^2 + (X_L - X_C)^2}$$

Where: Z = Total Impedance

ESR = Equivalent Series Resistance

X_C = Capacitive Reactance = 1/(2 πfC)

X_L = Inductive Reactance = (2 πf) (ESL)

The variation of a capacitor's impedance with frequency determines its effectiveness in many applications. At high frequency more detailed models apply - see KEMET SPICE models for such instances.

7. Insulation Resistance:

Measured after 2 minutes electrification at 25°C and rated voltage: Limits per Table 3.

Insulation Resistance is the measure of a capacitor to resist the flow of DC leakage current. It is sometimes referred to as “leakage resistance”. Insulation resistance (IR) is the DC resistance measured across the terminals of a capacitor, represented by the parallel resistance (IR) shown in Figure 1. For a given dielectric type, electrode area increases with capacitance, resulting in a decrease in the insulation resistance. Consequently, insulation resistance limits are usually specified as the “RC” (IR x C) product, in terms of ohm-farads or megohm-micro-farads. The insulation resistance for a specific capacitance value is determined by dividing this product by the capacitance. However, as the nominal capacitance values become small, the insulation resistance calculated from the RC product reaches values which are impractical. Consequently, IR specifications usually include both a minimum RC product and a maximum limit based on the IR calculated

Table 3 – Specified Electrical Limits

Parameter	Temperature Characteristics			
	C0G	X7R/X5R	Z5U	Y5V
Capacitance & Dissipation Factor: Measured at following conditions: C0G – 1kHz and 1 vrms if capacitance >1000 pF 1MHz and 1 vrms if capacitance ≤1000 pF X7R/X5R/Y5V – 1kHz and 1 vrms* if capacitance ≤ 10 μF X7R/X5R/Y5V – 120Hz and 0.5 vrms if capacitance > 10 μF Z5U – 1kHz and 0.5 vrms				
DF Limits: **X5R Cap DF 50 - 200 volts – <25V <564 5.0% 25 volts – <25V ≥564 10.0% 16 volts – 6.3/10 volts –	0.10% 0.10% ----- -----	2.5% 2.5% 3.5% 5.0% 3.5% ** 5.0%	4.0% 4.0% -----	5.0% 7.0% 7.0% 10.0%
Dielectric Strength: At 2.5 times rated DC voltage	Pass Subsequent IR Test			
Insulation Resistance (IR): At rated DC voltage, whichever of the two is smaller. To get IR limit, divide MΩ-μF value by the capacitance and compare to GΩ limit. Select the lower of the two limits.	1,000 MΩ – μF or 100 GΩ (100,000 MΩ)	1,000 MΩ – μF or 100 GΩ (100,000 MΩ)	100 MΩ – μF or 10 GΩ (10,000 MΩ)	100 MΩ – μF or 10 G (≥16 volt) 50 MΩ – μF or 10G (≤10v) (10,000 MΩ)
Temperature: Range, °C Capacitance Change (without DC voltage)	-55 to +125 0 ± 30 ppm/°C	X7R: -55 to +125 ±15% X5R: -55 to +85 ±15%	+10 to +85 +22% -56%	-30 to +85 +22% -82%

*Note: Some values measured at ½ volt, see X7R Table for specific details on pages 74 and 75.

from that value. For example, a typical IR specification might read “1,000 megohm-microfarads or 100 gigohms, whichever is less”. The DC leakage current may be calculated by dividing the applied voltage by the insulation resistance (Ohm's Law).

8. Dielectric Withstanding Voltage:
250% of rated voltage for 5 seconds with current limited to 50mA at 25°C. Limits per Table 3.

Dielectric withstanding voltage (DWW) is the peak DC voltage which a capacitor is designed to withstand without damage for short periods of time. All KEMET multilayer ceramic surface mount capacitors will withstand a DC test voltage of 2.5 x the rated voltage for 60 seconds.

KEMET specification limits for all electrical characteristics at standard measurement conditions are shown in Table 3. Variations in these properties caused by changing conditions (temperature, voltage, frequency, and time) are covered in the following sections.

9. Aging Rate:
Maximum % Capacitance Loss/Decade Hour

- C0G - 0%**
- X7R - 2.0%**
- X5R - 5.0%**
- Z5U - 7.0%**
- Y5V - 7.0%**

Actual rates may be lower. Consult factory for details.

The capacitance of Class II and III dielectric changes with time as well as with temperature, voltage and frequency. The change with time is known as “aging”. It is caused by gradual realignment of the crystalline structure of the ceramic dielectric material as it is cooled below its Curie temperature, which produces a loss of capacitance with time. The aging process is predictable and follows a logarithmic decay.

The aging process is reversible. If the capacitor is heated to a temperature above its Curie point for some period of time, de-aging will occur and the capacitor will regain the capacitance lost during the aging process. The amount of de-aging depends on both the elevated temperature and the length of time at that temperature. Exposure to 150°C for one-half hour is sufficient to return the capacitor to its initial value.

Because the capacitance changes rapidly immediately after de-aging, capacitance measurements are indexed to a referee time of 1,000 hours. All Kemet capacitors are shipped to be within tolerance at the referee time of 1,000 hours after the deaging process (this time is often referred to as "last heat"). The selection of this referee time has proven practical, as the actual decline of capacitance after 1,000 hours is very low.

10. Effect of Temperature:

Both capacitance and dissipation factor are affected by variations in temperature. The maximum capacitance change with temperature is defined by the temperature characteristic.

However, this only defines an “envelope” bounded by the upper and lower operating temperatures and the minimum and maximum capacitance values. Within this “envelope”, the variation with temperature depends upon the specific dielectric formulation.

Insulation resistance decreases with increasing temperature. Typically, the insulation resistance limit at maximum rated temperature is 10% of the 25°C value.

11. Effect of Voltage:

Certain high dielectric constant ceramic capacitors may show variation in values of capacitance and dissipation factor with various levels of applied AC and DC voltages. Such variation is a natural characteristic of ceramic capacitors, and should be considered by the circuit designer.

In general, ceramic capacitors with the lowest dielectric constant (C0G or NP0) are extremely stable, and show little or no variation in capacitance and/or dissipation factor. On the other hand, ceramic capacitors with the highest dielectric constant (Z5U & Y5V) may show significant variation, particularly in capacitance. Other dielectric formulations such as X7R and X5R will show less variation than Y5V, but more than C0G.

The application of AC voltages in the range of 10 to 20 VAC tends to increase the values of both the capacitance and dissipation factor, while higher AC voltages tend to produce decreases in both.

However, the variation of capacitance with applied DC is the parameter of most interest to design engineers. Figure 8 shows typical variation of capacitance with applied DC voltage for some standard dielectrics. As can be seen, the decrease in capacitance is greatest for the Y5V dielectric (the C0G is not plotted, since it would not have a perceptible capacitance nor dissipation factor change.)

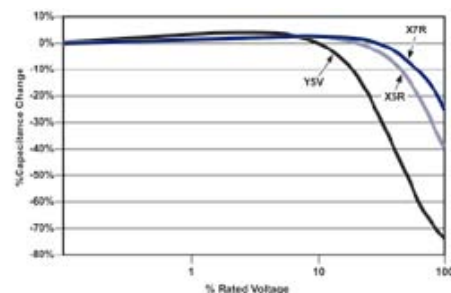

Figure 8 - Typical Variation of Capacitance with Applied DC Voltage (dissipation factor change.)

More detailed modelling information on the effect of various voltages on specific capacitor ratings can be obtained by use of the KEMET SPICE models, available for free downloading at our website (www.kemet.com).

12. Effect of Frequency:

Frequency affects both capacitance and dissipation factor. Typical curves for KEMET multilayer ceramic capacitors are shown in Figures 4, 5, 6 and 7.

The variation of impedance with frequency is an important consideration in the application of multilayer ceramic capacitors. Total impedance of the capacitor is

the vector summation of the capacitive reactance, the inductive reactance, and the ESR, as illustrated in Figure 2. As frequency increases, the capacitive reactance decreases. However, the series inductance (L) shown in Figure 1 produces some inductive reactance, which increases with frequency. At some frequency, the impedance ceases to be capacitive and becomes inductive. This point, at the bottom of the V-shaped impedance versus frequency curves, is the self-resonant frequency. At the self-resonant frequency, the reactance is zero, and the impedance consists of the ESR only. At high frequency more detailed models apply - See KEMET SPICE models for such instances.

Typical impedance versus frequency curves for KEMET multilayer ceramic capacitors are shown in Figures 4, 5, 6 and 7.

ENVIRONMENTAL AND PHYSICAL

13. **Thermal Shock:**
EIA-198, Method 202, Condition B (5 cycles -55° to + 125°C).
14. **Life Test:**
EIA-198, Method 201, 1000 hours at 200%* of rated voltage at 125°C. (Except 85°C for Z5U, Y5V & X5R).
See Table 4 on page 71 for limits.
*Note: 150% of rated voltage for selected high capacitance X5R values. Please contact factory.
15. **Humidity Test:**
EIA-198, Method 206, (Except 1000 hours, 85°C, 85% RH, Rated Voltage).
See Table 4 on page 71 for limits.
16. **Moisture Resistance:**
EIA-198, Method 204, Condition B (20 cycles with 50 volts applied).
See Table 4 on page 71 for limits.
17. **Solderability:**
EIA-198, Method 301 (245°, 5 secs, Sn62 solder) 95% smooth solder on terminations. See page 14 for recommended profiles.
18. **Resistance to Soldering Heat:**
EIA-198, Method 302, Condition B (260°C, 10 seconds) no leaching of nickel barrier.
19. **Terminal Strength:**
EIA-198, Method 303, Condition D .

RELIABILITY

20. A well constructed multilayer ceramic capacitor chip is extremely reliable and, for all practical purposes, has no wearout mechanism when used within the maximum voltage and temperature ratings. Most failures occur as a result of mechanical or thermal damage during mounting on the board, or during subsequent testing. Capacitor failure may also be induced by sustained operation at voltages that exceed the rated DC voltage, voltage spikes or transients that exceed the dielectric's voltage capability, sustained operation at temperatures above the maximum rated temperature, internal defects, or excessive temperature rise due to power

dissipation. As with any practical device, multilayer ceramic capacitors also possess an inherent, although low, failure rate when operated within rated conditions. The primary failure mode is by short-circuit or low insulation resistance, resulting from cracks or from dielectric breakdown at a defect site. KEMET monitors reliability with a periodic sampling program for selected values. Results are available in our FIT (Failure in Time) report for commercial chips.

21. Storage and Handling:

Ceramic chip capacitors should be stored in normal working environments. While the chips themselves are quite robust in other environments, solderability will be degraded by exposure to high temperatures, high humidity, corrosive atmospheres, and long term storage. In addition, packaging materials will be degraded by high temperature – reels may soften or warp, and tape peel force may increase. KEMET recommends that maximum storage temperature not exceed 40 degrees C, and maximum storage humidity not exceed 70% relative humidity. In addition, temperature fluctuations should be minimized to avoid condensation on the parts, and atmospheres should be free of chlorine and sulfur bearing compounds. For optimized solderability, chip stock should be used promptly, preferably within 1.5 years of receipt.

MISAPPLICATION

22. Ceramic capacitors, like any other capacitors, may fail if they are misapplied. Some misapplications include mechanical damage, such as impact or excessive flexing of the circuit board. Others include severe mounting or rework cycles that may also introduce thermal shock. Still others include exposure to excessive voltage, current or temperature. If the dielectric layer of the capacitor is damaged by misapplication, the circuit may fail. The electrical energy of the circuit can be released as heat, which may damage the circuit board and other components as well.

ADDITIONAL INFORMATION

23. Detailed application information can be found in KEMET Engineering Bulletins.
 - F-2100 Surface Mount-Mounting Pad Dimensions and Considerations
 - F-2102 Reflow Soldering Process
 - F-2105 Wave Solder Process
 - F-2103 Surface Mount Repair
 - F-2110 Capacitance Monitoring while Flex Testing
 - F-2111 Ceramic Chip Capacitors "Flex Cracks" - Understanding and Solutions

For analysis of high frequency applications, KEMET has SPICE models of most chip capacitors. Models may be downloaded from KEMET's website www.kemet.com.

Additional information is also available - See your KEMET representative for details or post your questions to KEMET's homepage on the web <http://www.kemet.com>.

TABLE 4 – ENVIRONMENTAL LIMITS

Body	Rated DC Voltage	Initial DF (%)	IR (GΩ or ΩF) whichever is less	DF (%) Post Life/ Hum/Moisture Resistance	Cap Shift (% or pf, whichever is greater) Post Life/ Hum/Moisture Resistance	IR (GΩ or ΩF) whichever is less Post Life/ Hum/Moisture Resistance
C0G	200*	0.1	100/1000	0.5	0.3% or ± 0.25 pf	10/100
	100	0.1	100/1000	0.5	0.3% or ± 0.25 pf	10/100
	50	0.1	100/1000	0.5	0.3% or ± 0.25 pf	10/100
	25	0.1	100/1000	0.5	0.3% or ± 0.25 pf	10/100
	16	0.1	100/1000	0.5	0.3% or ± 0.25 pf	10/100
X7R	200*	2.5	100/1000	3.0	± 20%	10/100
	100	2.5	100/1000	3.0	± 20%	10/100
	50	2.5	100/1000	3.0	± 20%	10/100
	25	3.5	100/1000	5.0	± 20%	10/100
	16	3.5	100/1000	5.0	± 20%	10/100
	6.3/10	5.0	100/1000	7.5	± 20%	10/100
X5R	50V all cap values	2.5	100/1000	3.0	± 20%	10/100
	25V all cap values	5.0	100/1000	7.5	± 20%	10/100
	<25≤564 cap value	5.0	100/1000	7.5	± 20%	10/100
	>564 cap value	10.0	100/1000	12.0	± 20%	10/100
Z5U	100	4.0	10/100	5.0	± 30%	1/10
	50	4.0	10/100	5.0	± 30%	1/10
	25	4.0	10/100	7.5	± 30%	1/10
Y5V	100	5.0	10/100	7.5	± 30%	1/10
	50	5.0	10/100	7.5	± 30%	1/10
	25	7.0	10/100	10.0	± 30%	1/10
	16	7.0	10/100	10.0	± 30%	1/10
	6.3/10	10.0	10/50	15.0	± 30%	1/5

*200 Volt limits not currently included in EIA-198.

PERFORMANCE CURVES EFFECT OF FREQUENCY (See SPICE models for specific ratings.)

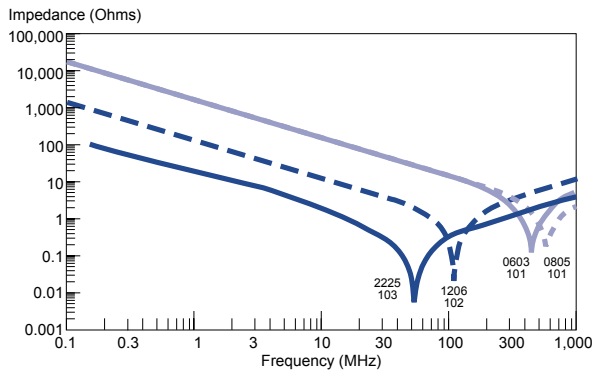

FIGURE 4. Impedance versus Frequency C0G Dielectric

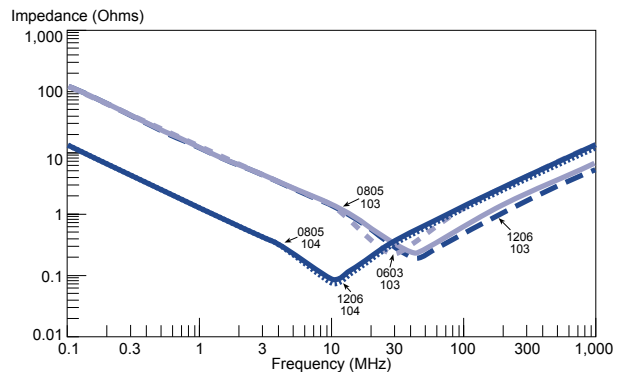

FIGURE 5. Impedance versus Frequency X7R Dielectric

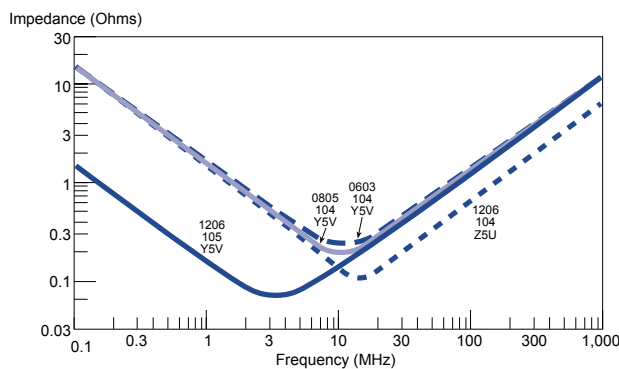

FIGURE 6. Impedance versus Frequency Z5U/Y5V Dielectric

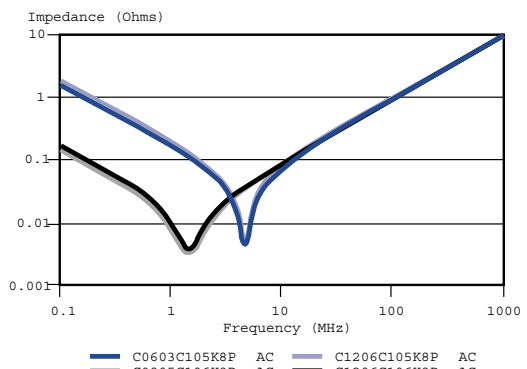

FIGURE 7. Impedance versus Frequency X5R Dielectric

Ceramic Surface Mount

FEATURES

- C0G (NP0), X7R, X5R, Z5U and Y5V Dielectrics
- 10, 16, 25, 50, 100 and 200 Volts
- Standard End Metallization: Tin-plate over nickel barrier
- Available Capacitance Tolerances: ± 0.10 pF; ± 0.25 pF; ± 0.5 pF; $\pm 1\%$; $\pm 2\%$; $\pm 5\%$; $\pm 10\%$; $\pm 20\%$; and $+80\%$ - 20%
- Tape and reel packaging per EIA481-1. (See page 92 for specific tape and reel information.) Bulk Cassette packaging (0402, 0603, 0805 only) per IEC60286-6 and EIAJ 7201.
- RoHS Compliant

CAPACITOR OUTLINE DRAWINGS

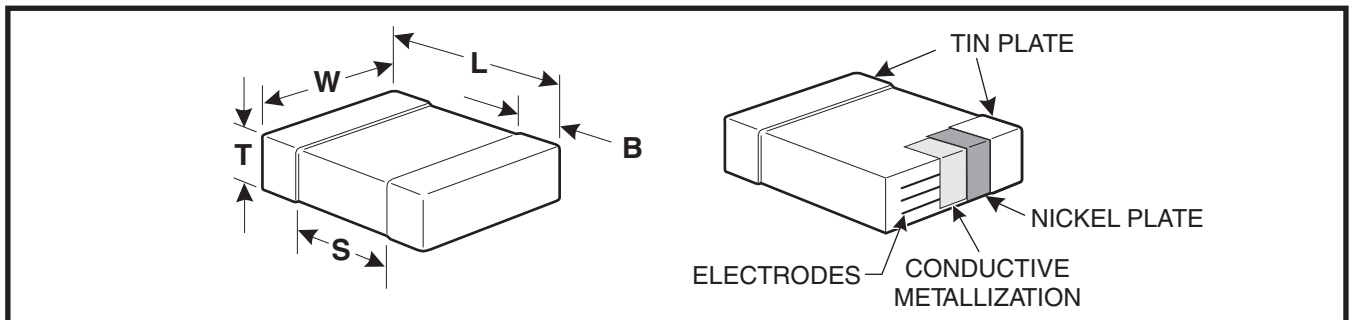

DIMENSIONS—MILLIMETERS AND (INCHES)

EIA SIZE CODE	METRIC SIZE CODE	L - LENGTH	W - WIDTH	T THICKNESS	B - BANDWIDTH	S SEPARATION minimum	MOUNTING TECHNIQUE
0201*	0603	0.6 (.024) \pm .03 (.001)	0.3 \pm (.012) \pm .03 (.001)	See page 78 for thickness dimensions.	0.15 (.006) \pm .05 (.002)	N/A	Solder Reflow
0402*	1005	1.0 (.04) \pm .05 (.002)	0.5 (.02) \pm .05 (.002)		0.20 (.008) \pm .40 (.016)	0.3 (.012)	
0603	1608	1.6 (.063) \pm .15 (.006)	0.8 (.032) \pm .15 (.006)		0.35 (.014) \pm .15 (.006)	0.7 (.028)	
0805*	2012	2.0 (.079) \pm .20 (.008)	1.25 (.049) \pm .20 (.008)		0.50 (.02) \pm .25 (.010)	0.75 (.030)	Solder Wave + or Solder Reflow
1206*	3216	3.2 (.126) \pm .20 (.008)	1.6 (.063) \pm .20 (.008)		0.50 (.02) \pm .25 (.010)	N/A	
1210*	3225	3.2 (.126) \pm .20 (.008)	2.5 (.098) \pm .20 (.008)		0.50 (.02) \pm .25 (.010)	N/A	
1812	4532	4.5 (.177) \pm .30 (.012)	3.2 (.126) \pm .30 (.012)		0.60 (.024) \pm .35 (.014)	N/A	Solder Reflow
1825*	4564	4.5 (.177) \pm .30 (.012)	6.4 (.252) \pm .40 (.016)		0.60 (.024) \pm .35 (.014)	N/A	
2220	5650	5.6 (.220) \pm .40 (.016)	5.0 (.197) \pm .40 (.016)		0.60 (.024) \pm .35 (.014)	N/A	
2225	5664	5.6 (.220) \pm .40 (.016)	6.3 (.248) \pm .40 (.016)		0.60 (.024) \pm .35 (.014)	N/A	

* Note: Indicates EIA Preferred Case Sizes (Tightened tolerances apply for 0402, 0603, and 0805 packaged in bulk cassette, see page 96.)

+ For extended value 1210 case size - solder reflow only.

CAPACITOR ORDERING INFORMATION (Standard Chips - For Military see page 87)

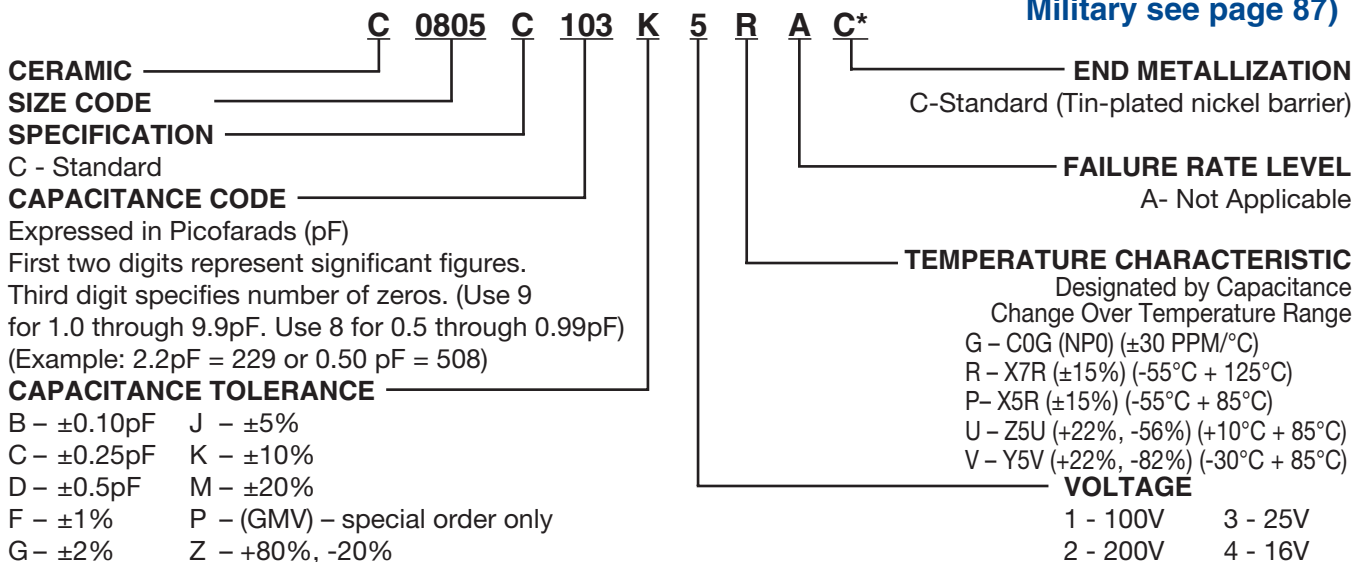

* Part Number Example: C0805C103K5RAC (14 digits - no spaces)

CERAMIC CHIP/CAPACITORS

Tin Lead L Termination



FEATURES

KEMET's line of Tin/Lead termination commercial MLCC surface mount capacitors are designed to meet the needs of the commercial, high reliability, and military customer applications where Tin/Lead plating is required. KEMET's Tin/Lead electroplating process is designed to meet a 5% minimum lead content in the termination of the component. As the bulk of the electronics industry marches to RoHS compliance it is important that KEMET provide the Tin/Lead terminated products for our valued high reliability and military customers.

KEMET Tin/Lead MLCC surface mount capacitors are available in standard EIA case sizes from 0402 to 2225 and standard capacitance values in X7R and C0G dielectrics. Voltage ratings range from 6.3V to 200V. To order the Tin/Lead terminations indicate an "L" in the 14th digit of the part number. To request the L Series termination for other surface mount product lines (Open Mode, High Voltage, Arrays, etc.) or for additional dielectrics and higher voltage ratings, please contact the factory or local Sales representative.

CAPACITOR OUTLINE DRAWINGS

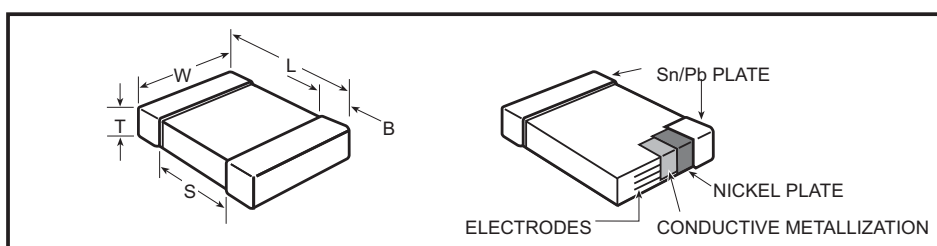

DIMENSIONS—MILLIMETERS AND (INCHES)

EIA SIZE CODE	METRIC SIZE CODE (Ref only)	L # LENGTH	W # WIDTH	See page 78 for thickness dimensions.	B BANDWIDTH	S MIN. SEPARATION	MOUNTING TECHNIQUE
0402*	1005	1.0 (.04) ± .05(.002)	0.5 (.02) ± .05 (.002)		0.20 (0.008)-0.40 (0.016)	0.3 (.012)	Solder Reflow
0603*	1608	1.6 (.063) ± 0.15 (.006)	0.8 (.032) ± 0.15 (.006)		0.35 (.014) ± 0.15 (.006)	0.7 (.028)	Solder Wave † or Solder Reflow
0805*	2012	2.0 (.079) ± 0.2 (.008)	1.25 (.049) ± 0.2 (.008)		0.5 (.02) ± .25 (.010)	0.75 (.030)	
1206*	3216	3.2 (.126) ± 0.2 (.008)	1.6 (.063) ± 0.2 (.008)		0.5 (.02) ± .25 (.010)	N/A	
1210*	3225	3.2 (.126) ± 0.2 (.008)	2.5 (.098) ± 0.2 (.008)		0.5 (.02) ± .25 (.010)	N/A	Solder Reflow
1812	4532	4.5 (.177) ± 0.3 (.012)	3.2 (.126) ± 0.3 (.012)		0.6 (.024) ± .35 (.014)	N/A	
1825*	4564	4.5 (.177) ± 0.3 (.012)	6.4 (.252) ± 0.4 (.016)		0.6 (.024) ± .35 (.014)	N/A	
2220	5650	5.6 (.220) ± 0.4 (.016)	5.0 (.197) ± 0.4 (.016)		0.6 (.024) ± .35 (.014)	N/A	
2225	5664	5.6 (.220) ± 0.4 (.016)	6.3 (.248) ± 0.4 (.016)		0.6 (.024) ± .35 (.014)	N/A	

* Note: Indicates EIA Preferred Case Sizes (Tightened tolerances apply for 0402, 0603, and 0805 packaged in bulk cassette, see page 96.)

† For extended value 1210 case size - solder reflow only.

CAPACITOR ORDERING INFORMATION (Standard Chips - For Military see page 87)

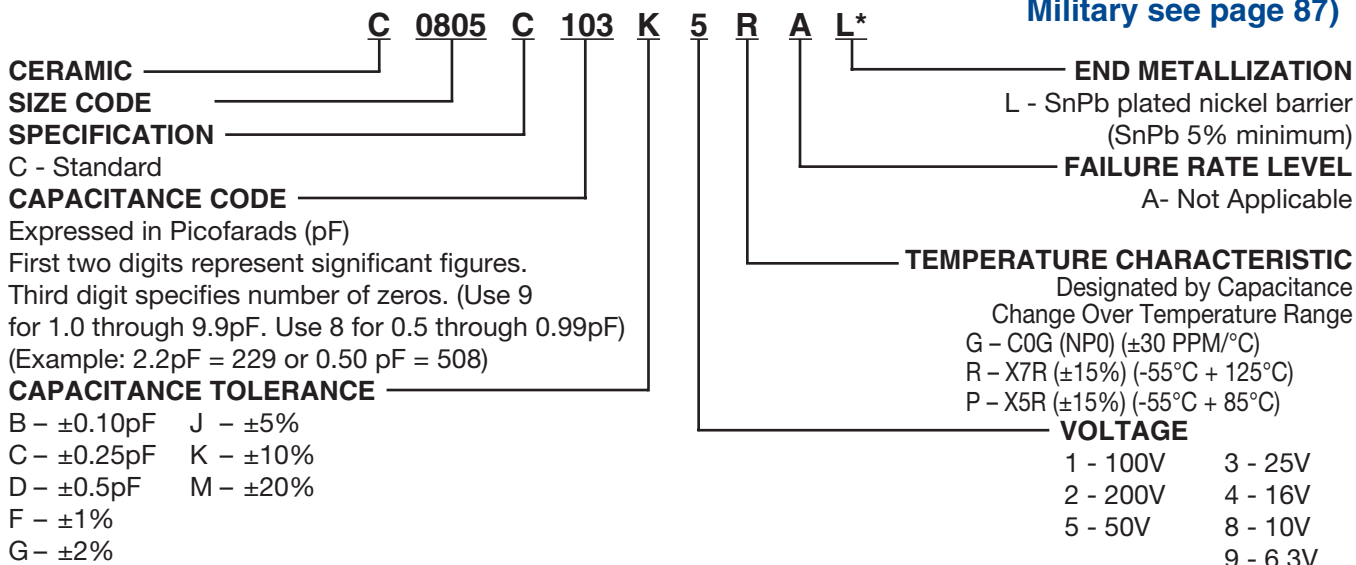

* Part Number Example: C0805C103K5RAL (14 digits - no spaces)

Refer to pages 73-76 for NP0/C0G, X7R and X5R dielectric capacitance ranges available.

©KEMET Electronics Corporation, P.O. Box 5928, Greenville, S.C. 29606, (864) 963-6300

CERAMIC CHIP CAPACITORS

Thickness Code Reference Chart
Packaging Quantity Based on Finished Chip Thickness Specifications

Thickness Code	Chip Size	Chip Thickness Range (mm)	Qty per Reel 7" Plastic	Qty per Reel 13" Plastic	Qty per Reel 7" Paper	Qty per Reel 13" Paper	Qty per Bulk Cassette
AA	0201	.30 ± .03	N/A	N/A	15,000	N/A	N/A
BB	0402	.50 ± .05	N/A	N/A	10,000	50,000	50,000
CB	0603	.80 ± .07	N/A	N/A	4,000	10,000	15,000
CC	0603	.80 ± .10	N/A	N/A	4,000	10,000	N/A
CD	0603	.80 ± .15	N/A	N/A	4,000	10,000	N/A
DB	0805	.60 ± .10	N/A	N/A	N/A	N/A	10,000
DC	0805	.78 ± .10	4,000	10,000	4,000	10,000	N/A
DD	0805	.90 ± .10	4,000	10,000	N/A	N/A	N/A
DE	0805	1.00 ± .10	2,500	10,000	N/A	N/A	N/A
DF	0805	1.10 ± .10	2,500	10,000	N/A	N/A	N/A
DG	0805	1.25 ± .15	2,500	10,000	N/A	N/A	N/A
DH	0805	1.25 ± .20	2,500	10,000	N/A	N/A	N/A
DJ	0805	1.25 ± .20	3,000	10,000	N/A	N/A	N/A
DK	0805	1.25 ± .15	3,000	10,000	N/A	N/A	N/A
EB	1206	.78 ± .10	4,000	10,000	4,000	10,000	N/A
EC	1206	.90 ± .10	4,000	10,000	N/A	N/A	N/A
ED	1206	1.00 ± .10	2,500	10,000	N/A	N/A	N/A
EE	1206	1.10 ± .10	2,500	10,000	N/A	N/A	N/A
EF	1206	1.20 ± .15	2,500	10,000	N/A	N/A	N/A
EG	1206	1.60 ± .15	2,000	8,000	N/A	N/A	N/A
EH	1206	1.60 ± .20	2,000	8,000	N/A	N/A	N/A
EJ	1206	1.70 ± .20	2,000	8,000	N/A	N/A	N/A
EK	1206	.80 ± .10	2,000	8,000	N/A	N/A	N/A
EL	1206	1.15 ± .15	2,000	8,000	N/A	N/A	N/A
EM	1206	1.25 ± .15	2,500	10,000	N/A	N/A	N/A
EN	1206	0.95 ± .10	4,000	10,000	N/A	N/A	N/A
FB	1210	.78 ± .10	4,000	10,000	N/A	N/A	N/A
FC	1210	.90 ± .10	4,000	10,000	N/A	N/A	N/A
FD	1210	.95 ± .10	4,000	10,000	N/A	N/A	N/A
FE	1210	1.00 ± .10	2,500	10,000	N/A	N/A	N/A
FF	1210	1.10 ± .10	2,500	10,000	N/A	N/A	N/A
FG	1210	1.25 ± .15	2,500	10,000	N/A	N/A	N/A
FH	1210	1.55 ± .15	2,000	8,000	N/A	N/A	N/A
FJ	1210	1.85 ± .20	2,000	8,000	N/A	N/A	N/A
FK	1210	2.10 ± .20	2,000	8,000	N/A	N/A	N/A
FL	1210	1.40 ± .15	2,000	8,000	N/A	N/A	N/A
FM	1210	1.70 ± .20	2,000	8,000	N/A	N/A	N/A
FN	1210	1.85 ± .20	2,000	8,000	N/A	N/A	N/A
FO	1210	1.50 ± .20	2,000	8,000	N/A	N/A	N/A
FP	1210	1.60 ± .20	2,000	8,000	N/A	N/A	N/A
FQ	1210	2.5 ± .20	1,500	8,000	N/A	N/A	N/A
FR	1210	2.25 ± .20	2,000	8,000	N/A	N/A	N/A
FS	1210	2.50 ± .20	1,000	4,000	N/A	N/A	N/A
GB	1812	1.00 ± .10	1,000	4,000	N/A	N/A	N/A
GC	1812	1.10 ± .10	1,000	4,000	N/A	N/A	N/A
GD	1812	1.25 ± .15	1,000	4,000	N/A	N/A	N/A
GE	1812	1.30 ± .10	1,000	4,000	N/A	N/A	N/A
GF	1812	1.50 ± .10	1,000	4,000	N/A	N/A	N/A
GG	1812	1.55 ± .10	1,000	4,000	N/A	N/A	N/A
GH	1812	1.40 ± .15	1,000	4,000	N/A	N/A	N/A
GJ	1812	1.70 ± .15	1,000	4,000	N/A	N/A	N/A
GK	1812	1.60 ± .20	1,000	4,000	N/A	N/A	N/A
GL	1812	1.90 ± .20	1,000	4,000	N/A	N/A	N/A
GM	1812	2.00 ± .20	1,000	4,000	N/A	N/A	N/A
GN	1812	1.70 ± .20	1,000	4,000	N/A	N/A	N/A
HB	1825	1.10 ± .15	1,000	4,000	N/A	N/A	N/A
HC	1825	1.15 ± .15	1,000	4,000	N/A	N/A	N/A
HD	1825	1.30 ± .15	1,000	4,000	N/A	N/A	N/A
HE	1825	1.40 ± .15	1,000	4,000	N/A	N/A	N/A
HF	1825	1.50 ± .15	1,000	4,000	N/A	N/A	N/A
JB	2220	1.00 ± .15	1,000	4,000	N/A	N/A	N/A
JC	2220	1.10 ± .15	1,000	4,000	N/A	N/A	N/A
JD	2220	1.30 ± .15	1,000	4,000	N/A	N/A	N/A
JE	2220	1.40 ± .15	1,000	4,000	N/A	N/A	N/A
JF	2220	1.50 ± .15	1,000	4,000	N/A	N/A	N/A
KB	2225	1.00 ± .15	1,000	4,000	N/A	N/A	N/A
KC	2225	1.10 ± .15	1,000	4,000	N/A	N/A	N/A
KD	2225	1.30 ± .15	1,000	4,000	N/A	N/A	N/A
KE	2225	1.40 ± .15	1,000	4,000	N/A	N/A	N/A

This chart refers to ceramic chip thickness codes on pages 73-76.

FEATURES

KEMET's Open Mode Ceramic Surface Mount Capacitor is designed to significantly minimize the probability of a low IR or Short Circuit Condition when forced to failure in a board flex situation. This reduces the potential for causing catastrophic failures. This product is RoHS Compliant.

Applications:

- Input side filtering (power plane/bus)
- High current applications (battery line)
- Circuits that cannot be fused to open when short circuits occur due to flex cracks

Markets:

- *Automotive*
 - All applications connected directly to the battery
 - Conversion to 42V power system
- *Power Conversion*
 - Raw power input side filtering

OUTLINE DRAWING

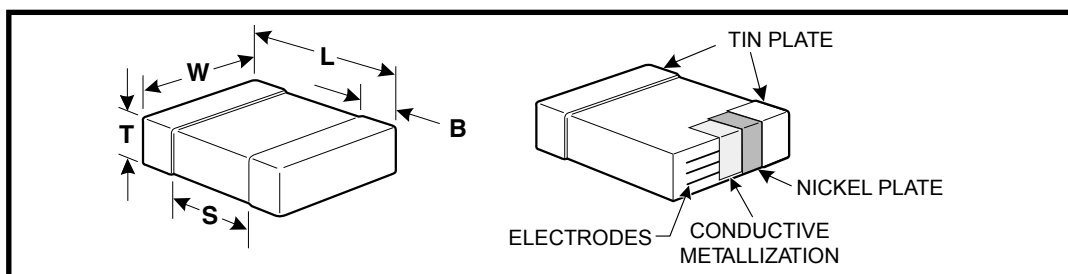
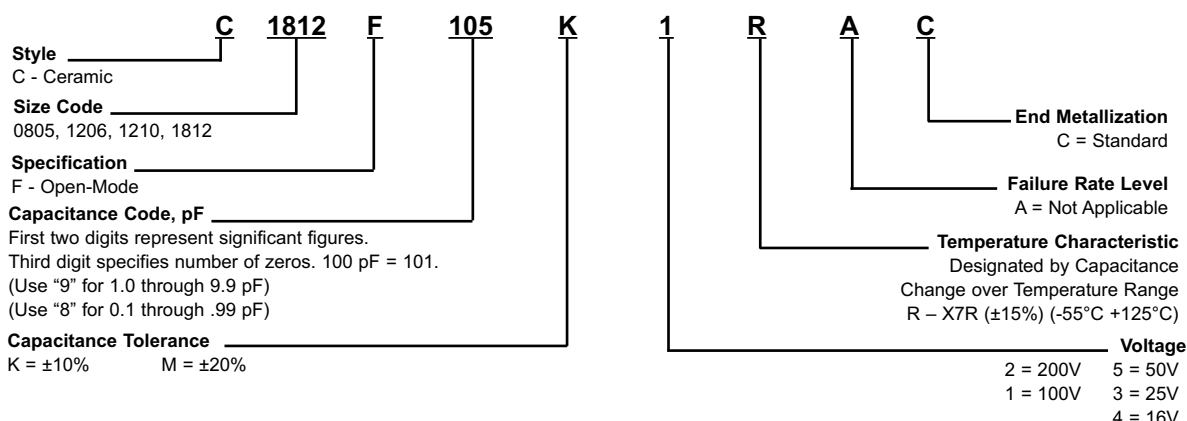

TABLE 1 - DIMENSIONS - MILLIMETERS (INCHES)

Metric Size Code	EIA Size Code	L - Length	W - Width	B - Bandwidth	Separation
2012	0805	2.0 (.079) ± .20 (.008)	1.25 (.049) ± 0.2 (.008)	0.50 (.02) ± .25 (.010)	0.75 (.030)
3216	1206	3.2 (.126) ± .20 (.008)	1.6 (.063) ± 0.2 (.008)	0.50 (.02) ± .25 (.010)	N/A
3225	1210	3.2 (.126) ± .20 (.008)	2.5 (.098) ± 0.2 (.008)	0.50 (.02) ± .25 (.010)	N/A
4532	1812	4.5 (.177) ± 0.3 (.012)	3.2 (.126) ± 0.3 (.012)	0.60 (.024) ± .35 (.014)	N/A

Note: For thickness dimensions, see Table 2.

CAPACITOR ORDERING INFORMATION



OPEN-MODE INTERNAL DESIGN

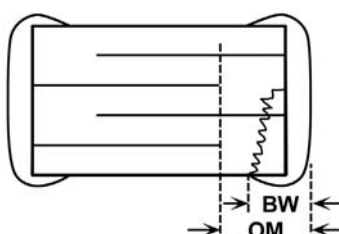

The open-mode dimension (OM) exceeds the termination bandwidth dimensions: OM > BW

Ceramic Surface Mount

TABLE 2
X7R DIELECTRIC CAPACITANCE RANGE AND THICKNESS TARGETS (mm)

Cap Code	0805					1206					1210					1812			
	16V	25V	50V	100V	200V	16V	25V	50V	100V	200V	16V	25V	50V	100V	200V	25V	50V	100V	200V
102	DD	DD	DD	DD	DD														
122	DD	DD	DD	DD	DD														
152	DD	DD	DD	DD	DD														
182	DD	DD	DD	DD	DD														
222	DD	DD	DD	DD	DD														
272	DD	DD	DD	DD	DD														
332	DD	DD	DD	DD	DD														
392	DD	DD	DD	DD	DD														
472	DD	DD	DD	DD	DD														
562	DD	DD	DD	DD	DD														
682	DD	DD	DD	DD	DD														
822	DD	DD	DD	DD	DD														
103	DD	DD	DD	DD	DD														
123	DD	DD	DD	DD	DG														
153	DD	DD	DD	DD	DG														
183	DD	DD	DD	DD						EC									
223	DD	DD	DD	DG						EC									
273	DD	DD	DD	DG						EC									
333	DD	DD	DD	DG						EC									
393	DD	DD	DD	DG						EC									
473	DD	DD	DD	DE		EC	EC	EC	EC	EG									GB
563	DD	DD	DD			EC	EC	EC	EC	EG									GB
683	DD	DD	DG	DG		EC	EC	EC	EC	EG				FD					GB
823	DD	DD	DG			EC	EC	EC	EC	EG				FD					GB
104	DG	DG	DG			EC	EC	EC	EC	EG	FD	FD	FD	FD	FG	GB	GB	GB	GB
124	DG	DG				EC	EC	EC	EC		FD	FD	FD	FD	FG	GB	GB	GB	GB
154	DG	DG				EC	EC	EC	EG		FD	FD	FD	FD	FH	GB	GB	GB	GB
184	DG	DG				EC	EC	EC	EG		FD	FD	FD	FD	FH	GB	GB	GB	GB
224	DG	DD	DG			EC	EC	EC	ED		FD	FD	FD	FG	FJ	GB	GB	GB	GC
274						EC	EC	EC			FD	FD	FD	FG		GB	GB	GB	GF
334						EG	EG	EG	EG		FD	FD	FD	FH		GB	GB	GB	GK
394						EG	EG				FD	FD	FG	FH		GB	GB	GB	GL
474	DE	DG				EG	EG	EC			FD	FD	FG	FJ		GB	GB	GC	
564						EG					FD	FD	FG	FR		GB	GB	GD	
684	DG					EG					FD	FG	FH	FR		GD	GD	GF	
824						EG					FD	FG	FJ			GD	GD	GK	
105						EG	EC	EH			FD	FH	FJ	FQ		GN	GN	GM	
125											FG								
155											FH								
185											FH								
225						EC	EH				FJ		FM						
475						EH					FG	FM							
685												FQ							

THICKNESS AND PACKAGING INFORMATION

Thickness Code	Series	Dimension	7" Reel Qty.	13" Reel Qty.
DD	0805	.90 ± .10	4000	10000
DE	0805	1.00 ± .10	2500	10000
DG	0805	1.25 ± .15	2500	10000
EC	1206	.90 ± .10	4000	10000
EG	1206	1.60 ± .15	2000	8000
EH	1206	1.60 ± .20	2000	8000
FD	1210	.95 ± .10	4000	10000
FG	1210	1.25 ± .15	2500	10000
FH	1210	1.55 ± .15	2000	8000
FJ	1210	1.85 ± .20	2000	8000
FM	1210	1.70 ± .20	2000	8000
FR	1210	2.25 ± .20	2000	8000
FQ	1210	2.5 ± .20	1500	8000
GB	1812	1.0 ± .10	1000	4000
GC	1812	1.1 ± .10	1000	4000
GD	1812	1.25 ± .15	1000	4000
GF	1812	1.50 ± .15	1000	4000
GK	1812	1.60 ± .20	1000	4000
GL	1812	1.90 ± .20	1000	4000
GM	1812	2.00 ± .20	1000	4000
GN	1812	1.70 ± .20	1000	4000

KEMET's High Voltage Surface Mount Capacitors are designed to withstand high voltage applications. They offer high capacitance with low leakage current and low ESR at high frequency. The capacitors have pure tin (Sn) plated external electrodes for good solderability. X7R dielectrics are not designed for AC line filtering applications. An insulating coating may be required to prevent surface arcing. These components are RoHS compliant.

APPLICATIONS

- Switch Mode Power Supply
 - Input Filter
 - Resonators
 - Tank Circuit
 - Snubber Circuit
 - Output Filter
- High Voltage Coupling
- High Voltage DC Blocking
- Lighting Ballast
- Voltage Multiplier Circuits
- Coupling Capacitor/CUK

MARKETS

- Power Supply
- High Voltage Power Supply
- DC-DC Converter
- LCD Fluorescent Backlight Ballast
- HID Lighting
- Telecommunications Equipment
- Industrial Equipment/Control
- Medical Equipment/Control
- Computer (LAN/WAN Interface)
- Analog and Digital Modems
- Automotive

OUTLINE DRAWING

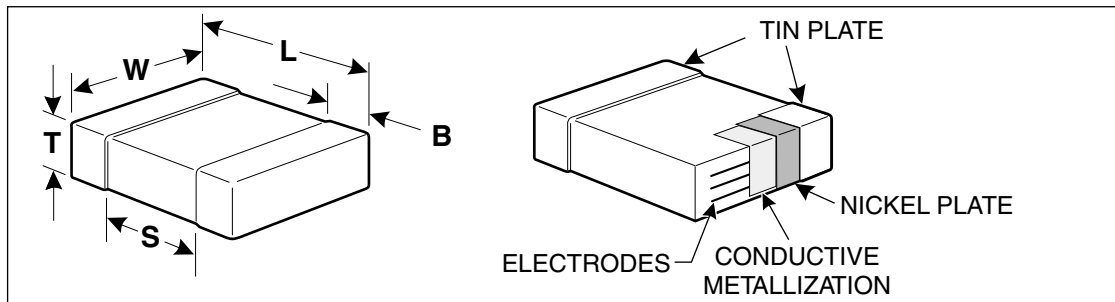
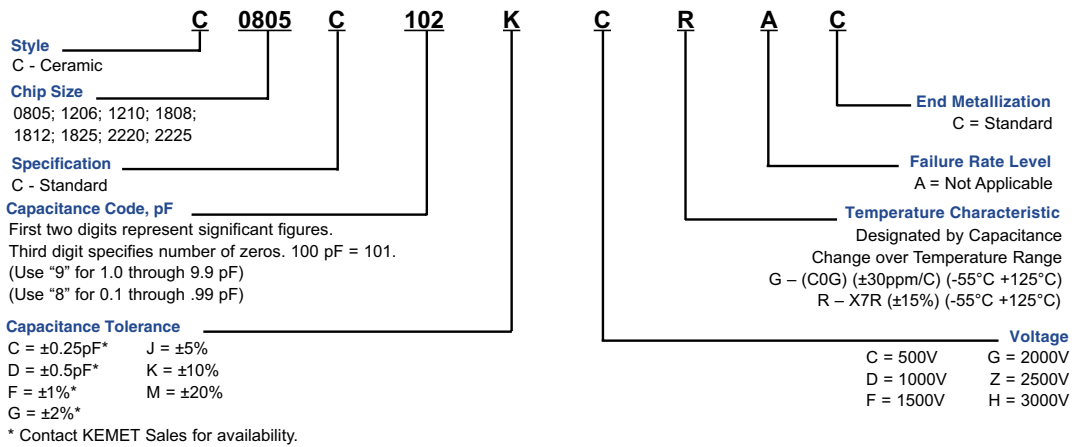

TABLE 1 - DIMENSIONS - MILLIMETERS (in.)

Metric Code	EIA Size Code	L - Length	W - Width	B - Bandwidth	Band Separation
2012	0805	2.0 (0.079) ± 0.2 (0.008)	1.2 (0.049) ± 0.2 (0.008)	0.5 (0.02) ±0.25 (0.010)	0.75 (0.030)
3216	1206	3.2 (0.126) ± 0.2 (0.008)	1.6 (0.063) ± 0.2 (0.008)	0.5 (0.02) ± 0.25 (0.010)	N/A
3225	1210	3.2 (0.126) ± 0.2 (0.008)	2.5 (0.098) ± 0.2 (0.008)	0.5 (0.02) ± 0.25 (0.010)	N/A
4520	1808	4.5 (0.177) ± 0.3 (0.012)	2.0 (0.079) ± 0.2 (0.008)	0.6 (0.024) ± 0.35 (0.014)	N/A
4532	1812	4.5 (0.177) ± 0.3 (0.012)	3.2 (0.126) ± 0.3 (0.012)	0.6 (0.024) ± 0.35 (0.014)	N/A
4564	1825	4.5 (0.177) ± 0.3 (0.012)	6.4 (0.250) ± 0.4 (0.016)	0.6 (0.024) ± 0.35 (0.014)	N/A
5650	2220	5.6 (0.224) ± 0.4 (0.016)	5.0 (0.197) ± 0.4 (0.016)	0.6 (0.024) ± 0.35 (0.014)	N/A
5664	2225	5.6 (0.224) ± 0.4 (0.016)	6.4 (0.250) ± 0.4 (0.016)	0.6 (0.024) ± 0.35 (0.014)	N/A

Ceramic Surface Mount

CAPACITOR ORDERING INFORMATION



ELECTRICAL PARAMETERS

Property	Specification
Capacitance	C0G: 1 pF to 0.010 μF X7R: 10pF to 0.22 μF 25°C, 1.0 ± 0.2 Vrms, 1 kHz (1 MHz for ≤ 1000 pF (C0G only))
Cap Tolerance	C0G: C*, D*, F*, G*, J, K, M * Contact KEMET Sales for availability. X7R: J, K, M
DF	C0G: 0.1% Max X7R: 2.5% Max
Voltage Ratings	500 V, 1000 V, 1500 V, 2000 V, 2500 V, 3000 V
Operating Temperature Range	From -55°C to +125°C
25°C IR @ 500V	100 GΩ or 1000 MΩ-μF, whichever is less
125°C IR @ 500V	10 GΩ or 100 MΩ-μF, whichever is less
-55°C TCC +125°C TCC	X7R: ± 15% C0G: ± 30 ppm / °C
Dielectric Strength	150% of Rated Voltage for Rated Voltage <1000 V 120% of Rated Voltage for Rated Voltage ≥1000V
Ripple Current	Consult KEMET Sales Representative

MARKING

These chips are supplied unmarked. If required, they can be supplied LASER-marked at an extra cost. Details on the marking format is located on page 97.

PACKAGING

KEMET High Voltage Surface Mount MLCC are available packaged in tape and reel configuration, or bulk bag as outlined on page 83. Please consult factory for waffle packaging options.

SOLDERING PROCESS

The 0805 and 1206 case sizes are suitable for either reflow or wave soldering processes. Sizes 1210 and larger should be limited to reflow soldering only. All sizes incorporate the standard KEMET barrier layer of pure nickel with an overplating of pure tin (Sn) for excellent solderability and resistance to solder leaching of the termination.

RECOMMENDED SOLDER PAD DIMENSIONS

Chip Size	T (Total Length)		S (Separation)		W (Pad Width)		L (Pad Length)	
	mm	in.	mm	in.	mm	in.	mm	in.
0805	3.30	0.130	0.70	0.028	1.60	0.063	1.30	0.051
1206	4.50	0.177	1.50	0.059	2.00	0.079	1.50	0.059
1210	4.50	0.177	1.50	0.059	2.90	0.114	1.50	0.059
1808	5.90	0.232	2.30	0.091	2.40	0.094	1.80	0.071
1812	5.90	0.232	2.30	0.091	3.70	0.146	1.80	0.071
1825	5.90	0.232	2.30	0.091	6.90	0.272	1.80	0.071
2220	7.00	0.276	3.30	0.130	5.50	0.217	1.85	0.073
2225	7.00	0.276	3.30	0.130	6.80	0.268	1.85	0.073

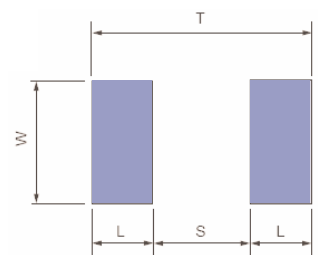

FEATURES

- Four individual capacitors inside one 1206 monolithic structure
- Saves board and inventory space
- One placement instead of four - less costly
- Easier to handle and solder than 4 smaller chips
- Tape and reel per EIA 481-1
- RoHS Compliant

CAPACITOR OUTLINE DRAWING

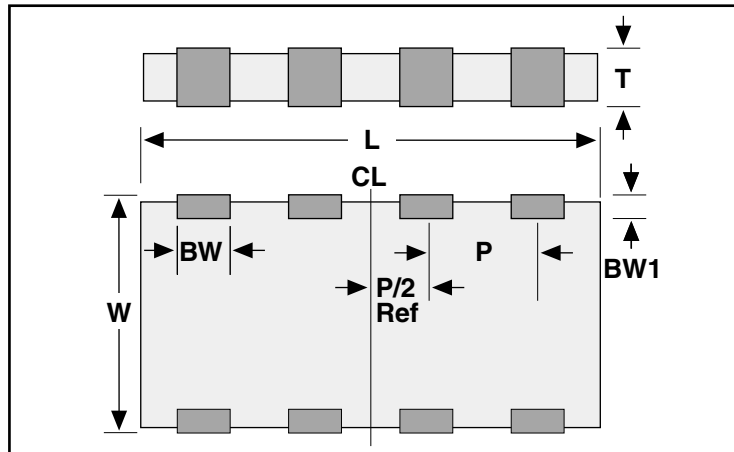

**TABLE 1
EIA DIMENSIONS – MILLIMETERS (INCHES)**

Size Code	Length L	Width W	Thickness T (max.)	Bandwidth BW	Bandwidth BW1	Pitch P
1632	3.2 (0.126) ± 0.2 (0.008)	1.6 (.063) ± 0.2 (.008)	0.7 - 1.35 (0.027 - 0.053)	0.40 (0.016) ± 0.2 (0.008)	0.1 - 0.5 (0.004 - 0.020)	0.8 (0.031) ± 0.1 (0.004)

Notes:

1. Metric is controlling - English for reference only.
2. Pitch (P) tolerances are non-cumulative along the package.
3. Thickness (T) depends on capacitance.

CERAMIC ARRAY ORDERING INFORMATION

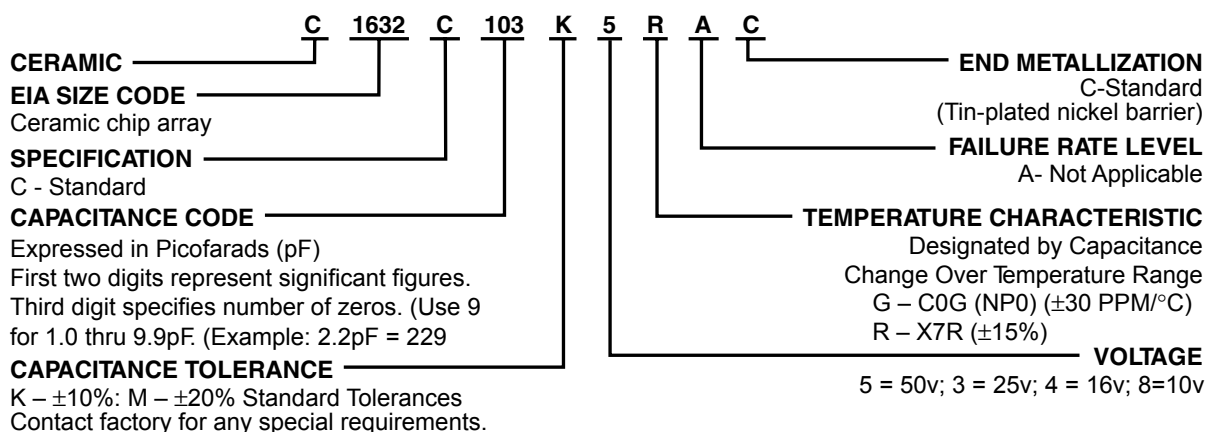

Ceramic Surface Mount

**TABLE 2A
C0G DIELECTRIC – CAPACITANCE RANGE**

Capacitance Values (pF)	KEMET Part Number	Capacitance Tolerance	10V 16V	25V	50V	100V	200V
10	C1632C100(1)(2)GAC	K,M	100	100	100	100	100
12	C1632C120(1)(2)GAC	K,M	120	120	120	120	120
15	C1632C150(1)(2)GAC	K,M	150	150	150	150	150
18	C1632C180(1)(2)GAC	K,M	180	180	180	180	180
22	C1632C220(1)(2)GAC	K,M	220	220	220	220	220
27	C1632C270(1)(2)GAC	K,M	270	270	270	270	270
33	C1632C330(1)(2)GAC	K,M	330	330	330	330	330
39	C1632C390(1)(2)GAC	K,M	390	390	390	390	390
47	C1632C470(1)(2)GAC	K,M	470	470	470	470	470
56	C1632C560(1)(2)GAC	K,M	560	560	560	560	560
68	C1632C680(1)(2)GAC	K,M	680	680	680	680	680
82	C1632C820(1)(2)GAC	K,M	820	820	820	820	820
100	C1632C101(1)(2)GAC	K,M	101	101	101	101	101
120	C1632C121(1)(2)GAC	K,M	121	121	121	121	121
150	C1632C151(1)(2)GAC	K,M	151	151	151	151	151
180	C1632C181(1)(2)GAC	K,M	181	181	181	181	181
220	C1632C221(1)(2)GAC	K,M	221	221	221	221	221
270	C1632C271(1)(2)GAC	K,M	271	271	271	271	271
330	C1632C331(1)(2)GAC	K,M	331	331	331	331	331
390	C1632C391(1)(2)GAC	K,M	391	391	391	391	391
470	C1632C471(1)(2)GAC	K,M	471	471	471	471	471

- (1) To complete the KEMET part number, insert the alpha code for the tolerance desired.
K = ±10% and M = ±20% – standard tolerance. Contact factory for any special requirements.
(2) To complete the KEMET part number, insert appropriate number for voltage desired:
"5" = 50 volts, "3" = 25 volts, "4" = 16 volts, and "8" = 10 volts.

**1632 CERAMIC ARRAY
LAND PATTERN LAYOUT**

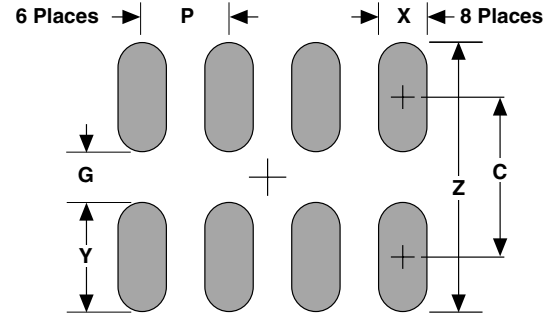

Additional pad dimension information is available in KEMET Technical Bulletin F-2100.

LAND PATTERN DIMENSIONS - CERAMIC CHIP CAPACITOR ARRAYS - MM

Dimension	Reflow Solder					
	Z	G	X	Y(ref)	C(ref)	P(ref)
3216	2.80	0.40	0.52	1.20	1.60	0.80

Calculation Formula
 $Z = Lmin + 2Jt + Tt$
 $G = Smax - 2Jh - Th$
 $X = Wmin + 2Js + Ts$
 Tt, Th, Ts = Combined tolerances

**TABLE 2B
X7R DIELECTRIC – CAPACITANCE RANGE**

Capacitance Values (pF)	KEMET Part Number	Capacitance Tolerance	10V 16V	25V	50V	100V	200V
330	C1632C331(1)(2)RAC	K,M	331	331	331	331	331
390	C1632C391(1)(2)RAC	K,M	391	391	391	391	391
470	C1632C471(1)(2)RAC	K,M	471	471	471	471	471
560	C1632C561(1)(2)RAC	K,M	561	561	561	561	561
680	C1632C681(1)(2)RAC	K,M	681	681	681	681	681
820	C1632C821(1)(2)RAC	K,M	821	821	821	821	821
1000	C1632C102(1)(2)RAC	K,M	102	102	102	102	102
1200	C1632C122(1)(2)RAC	K,M	122	122	122	122	122
1500	C1632C152(1)(2)RAC	K,M	152	152	152	152	152
1800	C1632C182(1)(2)RAC	K,M	182	182	182	182	182
2200	C1632C222(1)(2)RAC	K,M	222	222	222	222	222
2700	C1632C272(1)(2)RAC	K,M	272	272	272	272	272
3300	C1632C332(1)(2)RAC	K,M	332	332	332	332	332
3900	C1632C392(1)(2)RAC	K,M	392	392	392	392	392
4700	C1632C472(1)(2)RAC	K,M	472	472	472	472	472
5600	C1632C562(1)(2)RAC	K,M	562	562	562	562	562
6800	C1632C682(1)(2)RAC	K,M	682	682	682	682	682
8200	C1632C822(1)(2)RAC	K,M	822	822	822	822	822
10,000	C1632C103(1)(2)RAC	K,M	103	103	103	103	103
12,000	C1632C123(1)(2)RAC	K,M	123	123	123	123	123
15,000	C1632C153(1)(2)RAC	K,M	153	153	153	153	153
18,000	C1632C183(1)(2)RAC	K,M	183	183	183	183	183
22,000	C1632C223(1)(2)RAC	K,M	223	223	223	223	223
27,000	C1632C273(1)(2)RAC	K,M	273	273	273	273	273
33,000	C1632C333(1)(2)RAC	K,M	333	333	333	333	333
39,000	C1632C393(1)(2)RAC	K,M	393	393	393	393	393
47,000	C1632C473(1)(2)RAC	K,M	473	473	473	473	473
56,000	C1632C563(1)(2)RAC	K,M	563	563	563	563	563
68,000	C1632C683(1)(2)RAC	K,M	683	683	683	683	683
82,000	C1632C823(1)(2)RAC	K,M	823	823	823	823	823
100,000	C1632C104(1)(2)RAC	K,M	104	104	104	104	104

- (1) To complete the KEMET part number, insert the alpha code for the tolerance desired:
K = ±10% and M = ±20% – standard tolerances. Contact factory for any special requirements.
(2) To complete the KEMET part number, insert appropriate number for voltage desired:
"5" = 50 volts, "3" = 25 volts, "4" = 16 volts, and "8" = 10 volts.

CAPACITOR OUTLINE DRAWINGS

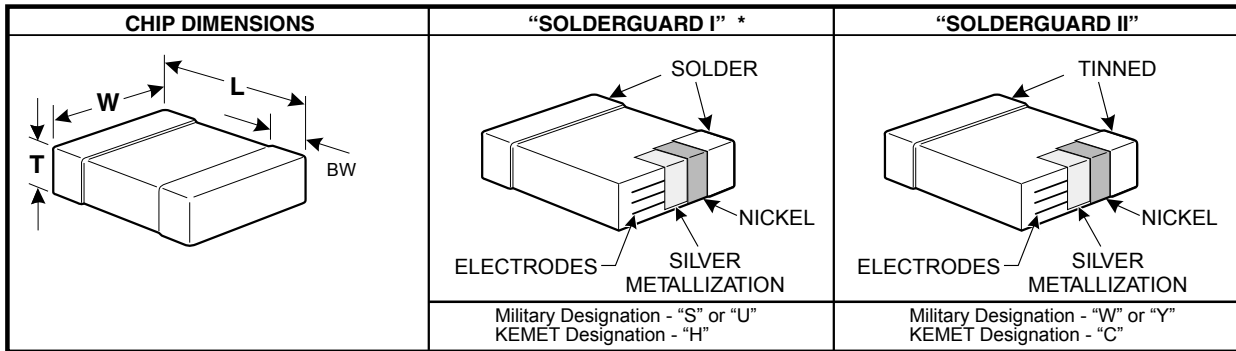

DIMENSIONS—MILLIMETERS AND (INCHES)

STYLE	KEMET SIZE CODE	L	W	T		BW
				MIN.	MAX.	
CDR01	C0805	2.03 ±.38 (.080 ±.015)	1.27 ±.38 (.050 ±.015)	.56 (.022)	1.40 (.055)	.51 ± 0.25 (.020 ±.010)
CDR02	C1805	4.57 ±.38 (.180 ±.015)	1.27 ±.38 (.050 ±.015)	.56 (.022)	1.40 (.055)	.51 ± 0.25 (.020 ±.010)
CDR03	C1808	4.57 ±.38 (.180 ±.015)	2.03 ±.38 (.080 ±.015)	.56 (.022)	2.03 (.080)	.51 ± 0.25 (.020 ±.010)
CDR04	C1812	4.57 ±.38 (.180 ±.015)	3.18 ±.38 (.125 ±.015)	.56 (.022)	2.03 (.080)	.51 ± 0.25 (.020 ±.010)
CDR05	C1825	$4.57 \begin{pmatrix} +.51 \\ +.020 \\ .180 \\ -.38 \end{pmatrix}$	$6.35 \begin{pmatrix} +.51 \\ +.020 \\ .250 \\ -.38 \end{pmatrix}$.51 (.020)	2.03 (.080)	.51 ± 0.25 (.020 ±.010)
CDR06	C2225	5.72 ±.51 (.225 ±.020)	6.35 ±.51 (.250 ±.020)	.51 (.020)	2.03 (.080)	.51 ± 0.25 (.020 ±.010)
CDR31	C0805	2.00 ±.20 (.078 ±.008)	1.25 ±.20 (.049 ±.008)		1.30 (.051)	.50 ± 0.20 (.020 ±.008)
CDR32	C1206	3.20 ±.20 (.125 ±.008)	1.60 ±.20 (.062 ±.008)		1.30 (.051)	.50 ± 0.20 (.020 ±.008)
CDR33	C1210	3.20 ±.25 (.125 ±.010)	2.50 ±.25 (.098 ±.010)		1.50 (.059)	.50 ± 0.25 (.020 ±.010)
CDR34	C1812	4.50 ±.25 (.176 ±.010)	3.20 ±.25 (.125 ±.010)		1.50 (.059)	.50 ± 0.25 (.020 ±.010)
CDR35	C1825	4.50 ±.30 (.176 ±.012)	6.40 ±.30 (.250 ±.012)		1.50 (.059)	.50 ± 0.30 (.020 ±.012)

Note: For SolderGuard I (MIL-C55681 "S" or "U" Endmets), the length, width and thickness positive tolerances (including bandwidth) cited above are allowed to increase by the following amounts:

	Length	Width/Thickness
CDR01	0.51MM (.020)	0.38MM (.015)
CDR02-06	0.64MM (.025)	0.38MM (.015)
CDR31-35	0.60MM (.023)	0.30MM (.012)

MIL-PRF-55681 PART NUMBER ORDERING INFORMATION

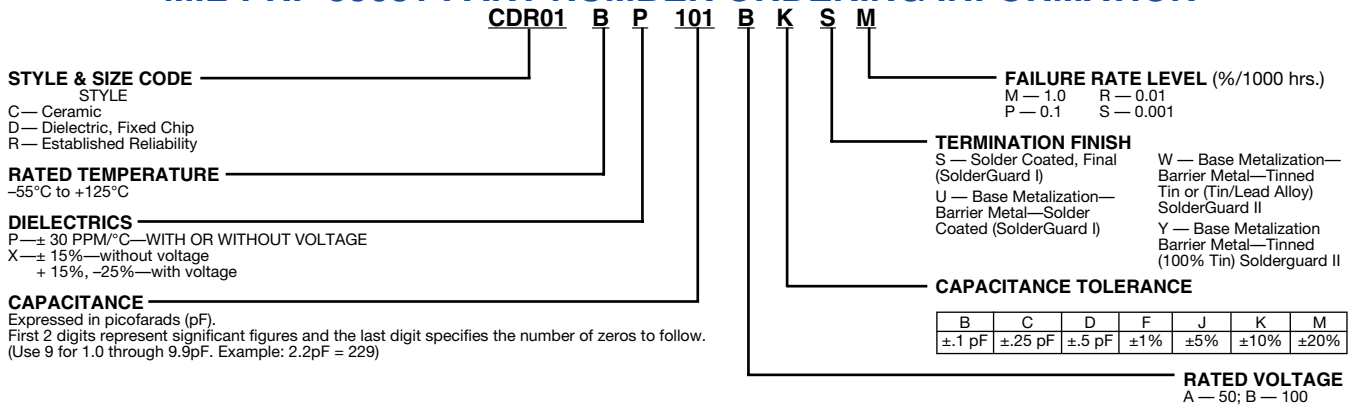

KEMET/MIL-PRF-55681 PART NUMBER EQUIVALENTS

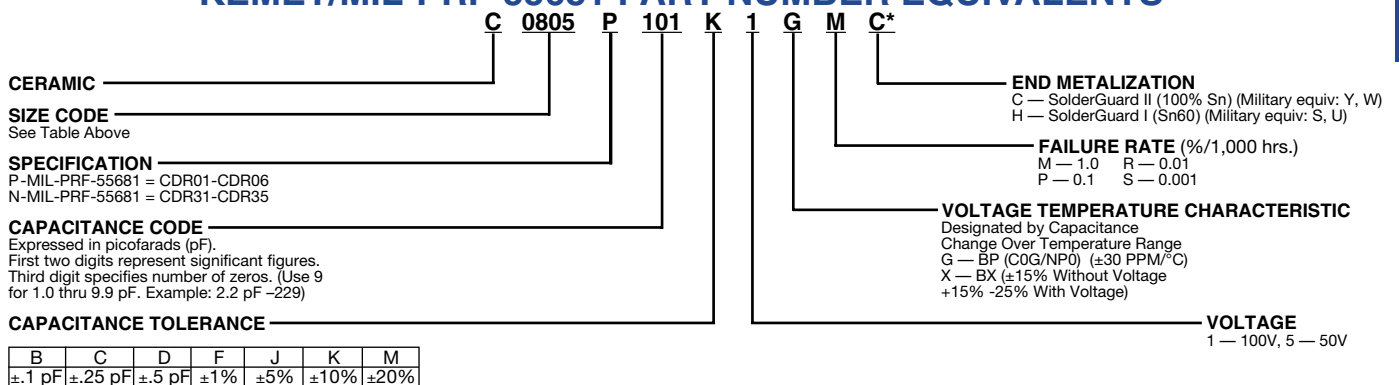

* Part Number Example: C0805P101K1GMC (14 digits - no spaces)

CERAMIC CHIP/MIL-PRF-55681

Established Reliability



RATINGS & PART NUMBER REFERENCE

CAP. pF	AVAIL. TOL.	KEMET CAPACITORS	MIL-PRF-55681 PART NUMBER
100 Volt — BP — C0805 SIZE (MILITARY CDR31)			
1.0	B,C	C0805N109(3)1G(4)C	CDR31BP1R0B(3)W(4)
1.1	B,C	C0805N119(3)1G(4)C	CDR31BP1R1B(3)W(4)
1.2	B,C	C0805N129(3)1G(4)C	CDR31BP1R2B(3)W(4)
1.3	B,C	C0805N139(3)1G(4)C	CDR31BP1R3B(3)W(4)
1.5	B,C	C0805N159(3)1G(4)C	CDR31BP1R5B(3)W(4)
1.6	B,C	C0805N169(3)1G(4)C	CDR31BP1R6B(3)W(4)
1.8	B,C	C0805N189(3)1G(4)C	CDR31BP1R8B(3)W(4)
2.0	B,C	C0805N209(3)1G(4)C	CDR31BP2R0B(3)W(4)
2.2	B,C	C0805N229(3)1G(4)C	CDR31BP2R2B(3)W(4)
2.4	B,C	C0805N249(3)1G(4)C	CDR31BP2R4B(3)W(4)
2.7	B,C,D	C0805N279(3)1G(4)C	CDR31BP2R7B(3)W(4)
3.0	B,C,D	C0805N309(3)1G(4)C	CDR31BP3R0B(3)W(4)
3.3	B,C,D	C0805N339(3)1G(4)C	CDR31BP3R3B(3)W(4)
3.6	B,C,D	C0805N369(3)1G(4)C	CDR31BP3R6B(3)W(4)
3.9	B,C,D	C0805N399(3)1G(4)C	CDR31BP3R9B(3)W(4)
4.3	B,C,D	C0805N439(3)1G(4)C	CDR31BP4R3B(3)W(4)
4.7	B,C,D	C0805N479(3)1G(4)C	CDR31BP4R7B(3)W(4)
5.1	B,C,D	C0805N519(3)1G(4)C	CDR31BP5R1B(3)W(4)
5.6	B,C,D	C0805N569(3)1G(4)C	CDR31BP5R6B(3)W(4)
6.2	B,C,D	C0805N629(3)1G(4)C	CDR31BP6R2B(3)W(4)
6.8	B,C,D	C0805N689(3)1G(4)C	CDR31BP6R8B(3)W(4)
7.5	B,C,D	C0805N759(3)1G(4)C	CDR31BP7R5B(3)W(4)
8.2	B,C,D	C0805N829(3)1G(4)C	CDR31BP8R2B(3)W(4)
9.1	B,C,D	C0805N919(3)1G(4)C	CDR31BP9R1B(3)W(4)
10	F,J,K	C0805N100(3)1G(4)C	CDR31BP100B(3)W(4)
11	F,J,K	C0805N110(3)1G(4)C	CDR31BP110B(3)W(4)
12	F,J,K	C0805N120(3)1G(4)C	CDR31BP120B(3)W(4)
13	F,J,K	C0805N130(3)1G(4)C	CDR31BP130B(3)W(4)
15	F,J,K	C0805N150(3)1G(4)C	CDR31BP150B(3)W(4)
16	F,J,K	C0805N160(3)1G(4)C	CDR31BP160B(3)W(4)
18	F,J,K	C0805N180(3)1G(4)C	CDR31BP180B(3)W(4)
20	F,J,K	C0805N200(3)1G(4)C	CDR31BP200B(3)W(4)
22	F,J,K	C0805N220(3)1G(4)C	CDR31BP220B(3)W(4)
24	F,J,K	C0805N240(3)1G(4)C	CDR31BP240B(3)W(4)
27	F,J,K	C0805N270(3)1G(4)C	CDR31BP270B(3)W(4)
30	F,J,K	C0805N300(3)1G(4)C	CDR31BP300B(3)W(4)
33	F,J,K	C0805N330(3)1G(4)C	CDR31BP330B(3)W(4)
36	F,J,K	C0805N360(3)1G(4)C	CDR31BP360B(3)W(4)
39	F,J,K	C0805N390(3)1G(4)C	CDR31BP390B(3)W(4)
43	F,J,K	C0805N430(3)1G(4)C	CDR31BP430B(3)W(4)
47	F,J,K	C0805N470(3)1G(4)C	CDR31BP470B(3)W(4)
51	F,J,K	C0805N510(3)1G(4)C	CDR31BP510B(3)W(4)
56	F,J,K	C0805N560(3)1G(4)C	CDR31BP560B(3)W(4)
62	F,J,K	C0805N620(3)1G(4)C	CDR31BP620B(3)W(4)
68	F,J,K	C0805N680(3)1G(4)C	CDR31BP680B(3)W(4)
75	F,J,K	C0805N750(3)1G(4)C	CDR31BP750B(3)W(4)
82	F,J,K	C0805N820(3)1G(4)C	CDR31BP820B(3)W(4)

CAP. pF	AVAIL. TOL.	KEMET CAPACITORS	MIL-PRF-55681 PART NUMBER
100 Volt — BP — C0805 SIZE (MILITARY CDR31)			
91	F,J,K	C0805N910(3)1G(4)C	CDR31BP910B(3)W(4)
100	F,J,K	C0805N101(3)1G(4)C	CDR31BP101B(3)W(4)
110	F,J,K	C0805N111(3)1G(4)C	CDR31BP111B(3)W(4)
120	F,J,K	C0805N121(3)1G(4)C	CDR31BP121B(3)W(4)
130	F,J,K	C0805N131(3)1G(4)C	CDR31BP131B(3)W(4)
150	F,J,K	C0805N151(3)1G(4)C	CDR31BP151B(3)W(4)
160	F,J,K	C0805N161(3)1G(4)C	CDR31BP161B(3)W(4)
180	F,J,K	C0805N181(3)1G(4)C	CDR31BP181B(3)W(4)
200	F,J,K	C0805N201(3)1G(4)C	CDR31BP201B(3)W(4)
220	F,J,K	C0805N221(3)1G(4)C	CDR31BP221B(3)W(4)
240	F,J,K	C0805N241(3)1G(4)C	CDR31BP241B(3)W(4)
270	F,J,K	C0805N271(3)1G(4)C	CDR31BP271B(3)W(4)
300	F,J,K	C0805N301(3)1G(4)C	CDR31BP301B(3)W(4)
330	F,J,K	C0805N331(3)1G(4)C	CDR31BP331B(3)W(4)
360	F,J,K	C0805N361(3)1G(4)C	CDR31BP361B(3)W(4)
390	F,J,K	C0805N391(3)1G(4)C	CDR31BP391B(3)W(4)
430	F,J,K	C0805N431(3)1G(4)C	CDR31BP431B(3)W(4)
470	F,J,K	C0805N471(3)1G(4)C	CDR31BP471B(3)W(4)
50 Volt — BP — C0805 SIZE (MILITARY CDR31)			
510	F,J,K	C0805N511(3)5G(4)C	CDR31BP511A(3)W(4)
560	F,J,K	C0805N561(3)5G(4)C	CDR31BP561A(3)W(4)
620	F,J,K	C0805N621(3)5G(4)C	CDR31BP621A(3)W(4)
680	F,J,K	C0805N681(3)5G(4)C	CDR31BP681A(3)W(4)
100 Volt — BX — C0805 SIZE (MILITARY CDR31)			
470	K,M	C0805N471(3)1X(4)C	CDR31BX471B(3)W(4)
560	K,M	C0805N561(3)1X(4)C	CDR31BX561B(3)W(4)
680	K,M	C0805N681(3)1X(4)C	CDR31BX681B(3)W(4)
820	K,M	C0805N821(3)1X(4)C	CDR31BX821B(3)W(4)
1,000	K,M	C0805N102(3)1X(4)C	CDR31BX102B(3)W(4)
1,200	K,M	C0805N122(3)1X(4)C	CDR31BX122B(3)W(4)
1,500	K,M	C0805N152(3)1X(4)C	CDR31BX152B(3)W(4)
1,800	K,M	C0805N182(3)1X(4)C	CDR31BX182B(3)W(4)
2,200	K,M	C0805N222(3)1X(4)C	CDR31BX222B(3)W(4)
2,700	K,M	C0805N272(3)1X(4)C	CDR31BX272B(3)W(4)
3,300	K,M	C0805N332(3)1X(4)C	CDR31BX332B(3)W(4)
3,900	K,M	C0805N392(3)1X(4)C	CDR31BX392B(3)W(4)
4,700	K,M	C0805N472(3)1X(4)C	CDR31BX472B(3)W(4)
50 Volt — BX — C0805 SIZE (MILITARY CDR31)			
5,600	K,M	C0805N562(3)5X(4)C	CDR31BX562A(3)W(4)
6,800	K,M	C0805N682(3)5X(4)C	CDR31BX682A(3)W(4)
8,200	K,M	C0805N822(3)5X(4)C	CDR31BX822A(3)W(4)
10,000	K,M	C0805N103(3)5X(4)C	CDR31BX103A(3)W(4)
12,000	K,M	C0805N123(3)5X(4)C	CDR31BX123A(3)W(4)
15,000	K,M	C0805N153(3)5X(4)C	CDR31BX153A(3)W(4)
18,000	K,M	C0805N183(3)5X(4)C	CDR31BX183A(3)W(4)

Ceramic Surface Mount

- (1) To complete Part Number for Dielectric, insert P or X symbol – as defined by Military specification.
- (2) To complete Part Number for Dielectric, insert G or X symbol. (“G” for Military “BP,” or “X” for Military “BX.”)
- (3) To complete Part Number, insert Capacitance Tolerance Symbol (when applicable) as available in MIL-PRF-55681: B – ± 0.1 pF, C – ± 0.25 pF, D – ± 0.5 pF, F – $\pm 1\%$, J – $\pm 5\%$, K – $\pm 10\%$, M – $\pm 20\%$. **NOTE: Available tolerances are listed in columns above.**
- (4) To complete Part Number, insert Failure Rate Symbol: M – 1.0%; P – 0.1%; R – 0.01%; S – .001%.

Note: All MIL-PRF-55681 and KEMET Part Numbers tabulated above assume use of Solderguard II (MIL-PRF-55681 “W”; KEMET “C”) end metal-ization. If MIL-PRF-55681 “U” or “S” (KEMET “H”) or MIL-PRF-55681 “Y” (KEMET “C”) is required, please change designators accordingly.

MARKING

See page 97 for MIL-PRF-55681 Marking



CERAMIC CHIP/MIL-PRF-55681

Established Reliability

RATINGS & PART NUMBER REFERENCE

CAP. pF	AVAIL. TOL.	KEMET CAPACITORS	MIL-PRF-55681 PART NUMBER
100 Volt — BP — C1206 SIZE (MILITARY CDR32)			
1.0	B,C	C1206N109(3)1G(4)C	CDR32BP1R0B(3)W(4)
1.1	B,C	C1206N119(3)1G(4)C	CDR32BP1R1B(3)W(4)
1.2	B,C	C1206N129(3)1G(4)C	CDR32BP1R2B(3)W(4)
1.3	B,C	C1206N139(3)1G(4)C	CDR32BP1R3B(3)W(4)
1.5	B,C	C1206N159(3)1G(4)C	CDR32BP1R5B(3)W(4)
1.6	B,C	C1206N169(3)1G(4)C	CDR32BP1R6B(3)W(4)
1.8	B,C	C1206N189(3)1G(4)C	CDR32BP1R8B(3)W(4)
2.0	B,C	C1206N209(3)1G(4)C	CDR32BP2R0B(3)W(4)
2.2	B,C	C1206N229(3)1G(4)C	CDR32BP2R2B(3)W(4)
2.4	B,C	C1206N249(3)1G(4)C	CDR32BP2R4B(3)W(4)
2.7	B,C,D	C1206N279(3)1G(4)C	CDR32BP2R7B(3)W(4)
3.0	B,C,D	C1206N309(3)1G(4)C	CDR32BP3R0B(3)W(4)
3.3	B,C,D	C1206N339(3)1G(4)C	CDR32BP3R3B(3)W(4)
3.6	B,C,D	C1206N369(3)1G(4)C	CDR32BP3R6B(3)W(4)
3.9	B,C,D	C1206N399(3)1G(4)C	CDR32BP3R9B(3)W(4)
4.3	B,C,D	C1206N439(3)1G(4)C	CDR32BP4R3B(3)W(4)
4.7	B,C,D	C1206N479(3)1G(4)C	CDR32BP4R7B(3)W(4)
5.1	B,C,D	C1206N519(3)1G(4)C	CDR32BP5R1B(3)W(4)
5.6	B,C,D	C1206N569(3)1G(4)C	CDR32BP5R6B(3)W(4)
6.2	B,C,D	C1206N629(3)1G(4)C	CDR32BP6R2B(3)W(4)
6.8	B,C,D	C1206N689(3)1G(4)C	CDR32BP6R8B(3)W(4)
7.5	B,C,D	C1206N759(3)1G(4)C	CDR32BP7R5B(3)W(4)
8.2	B,C,D	C1206N829(3)1G(4)C	CDR32BP8R2B(3)W(4)
9.1	B,C,D	C1206N919(3)1G(4)C	CDR32BP9R1B(3)W(4)
10	F,J,K	C1206N100(3)1G(4)C	CDR32BP100B(3)W(4)
11	F,J,K	C1206N110(3)1G(4)C	CDR32BP110B(3)W(4)
12	F,J,K	C1206N120(3)1G(4)C	CDR32BP120B(3)W(4)
13	F,J,K	C1206N130(3)1G(4)C	CDR32BP130B(3)W(4)
15	F,J,K	C1206N150(3)1G(4)C	CDR32BP150B(3)W(4)
16	F,J,K	C1206N160(3)1G(4)C	CDR32BP160B(3)W(4)
18	F,J,K	C1206N180(3)1G(4)C	CDR32BP180B(3)W(4)
20	F,J,K	C1206N200(3)1G(4)C	CDR32BP200B(3)W(4)
22	F,J,K	C1206N220(3)1G(4)C	CDR32BP220B(3)W(4)
24	F,J,K	C1206N240(3)1G(4)C	CDR32BP240B(3)W(4)
27	F,J,K	C1206N270(3)1G(4)C	CDR32BP270B(3)W(4)
30	F,J,K	C1206N300(3)1G(4)C	CDR32BP300B(3)W(4)
33	F,J,K	C1206N330(3)1G(4)C	CDR32BP330B(3)W(4)
36	F,J,K	C1206N360(3)1G(4)C	CDR32BP360B(3)W(4)
39	F,J,K	C1206N390(3)1G(4)C	CDR32BP390B(3)W(4)
43	F,J,K	C1206N430(3)1G(4)C	CDR32BP430B(3)W(4)
47	F,J,K	C1206N470(3)1G(4)C	CDR32BP470B(3)W(4)
51	F,J,K	C1206N510(3)1G(4)C	CDR32BP510B(3)W(4)
56	F,J,K	C1206N560(3)1G(4)C	CDR32BP560B(3)W(4)
62	F,J,K	C1206N620(3)1G(4)C	CDR32BP620B(3)W(4)
68	F,J,K	C1206N680(3)1G(4)C	CDR32BP680B(3)W(4)
75	F,J,K	C1206N750(3)1G(4)C	CDR32BP750B(3)W(4)
82	F,J,K	C1206N820(3)1G(4)C	CDR32BP820B(3)W(4)
91	F,J,K	C1206N910(3)1G(4)C	CDR32BP910B(3)W(4)
100	F,J,K	C1206N101(3)1G(4)C	CDR32BP101B(3)W(4)

CAP. pF	AVAIL. TOL.	KEMET CAPACITORS	MIL-PRF-55681 PART NUMBER
100 Volt — BP — C1206 SIZE (MILITARY CDR32)			
110	F,J,K	C1206N111(3)1G(4)C	CDR32BP111B(3)W(4)
120	F,J,K	C1206N121(3)1G(4)C	CDR32BP121B(3)W(4)
130	F,J,K	C1206N131(3)1G(4)C	CDR32BP131B(3)W(4)
150	F,J,K	C1206N151(3)1G(4)C	CDR32BP151B(3)W(4)
160	F,J,K	C1206N161(3)1G(4)C	CDR32BP161B(3)W(4)
180	F,J,K	C1206N181(3)1G(4)C	CDR32BP181B(3)W(4)
200	F,J,K	C1206N201(3)1G(4)C	CDR32BP201B(3)W(4)
220	F,J,K	C1206N221(3)1G(4)C	CDR32BP221B(3)W(4)
240	F,J,K	C1206N241(3)1G(4)C	CDR32BP241B(3)W(4)
270	F,J,K	C1206N271(3)1G(4)C	CDR32BP271B(3)W(4)
300	F,J,K	C1206N301(3)1G(4)C	CDR32BP301B(3)W(4)
330	F,J,K	C1206N331(3)1G(4)C	CDR32BP331B(3)W(4)
360	F,J,K	C1206N361(3)1G(4)C	CDR32BP361B(3)W(4)
390	F,J,K	C1206N391(3)1G(4)C	CDR32BP391B(3)W(4)
430	F,J,K	C1206N431(3)1G(4)C	CDR32BP431B(3)W(4)
470	F,J,K	C1206N471(3)1G(4)C	CDR32BP471B(3)W(4)
510	F,J,K	C1206N511(3)1G(4)C	CDR32BP511B(3)W(4)
560	F,J,K	C1206N561(3)1G(4)C	CDR32BP561B(3)W(4)
620	F,J,K	C1206N621(3)1G(4)C	CDR32BP621B(3)W(4)
680	F,J,K	C1206N681(3)1G(4)C	CDR32BP681B(3)W(4)
750	F,J,K	C1206N751(3)1G(4)C	CDR32BP751B(3)W(4)
820	F,J,K	C1206N821(3)1G(4)C	CDR32BP821B(3)W(4)
910	F,J,K	C1206N911(3)1G(4)C	CDR32BP911B(3)W(4)
1,000	F,J,K	C1206N102(3)1G(4)C	CDR32BP102B(3)W(4)
50 Volt — BP — C1206 SIZE (MILITARY CDR32)			
1,100	F,J,K	C1206N112(3)5G(4)C	CDR32BP112A(3)W(4)
1,200	F,J,K	C1206N122(3)5G(4)C	CDR32BP122A(3)W(4)
1,300	F,J,K	C1206N132(3)5G(4)C	CDR32BP132A(3)W(4)
1,500	F,J,K	C1206N152(3)5G(4)C	CDR32BP152A(3)W(4)
1,600	F,J,K	C1206N162(3)5G(4)C	CDR32BP162A(3)W(4)
1,800	F,J,K	C1206N182(3)5G(4)C	CDR32BP182A(3)W(4)
2,000	F,J,K	C1206N202(3)5G(4)C	CDR32BP202A(3)W(4)
2,200	F,J,K	C1206N222(3)5G(4)C	CDR32BP222A(3)W(4)
100 Volt — BX — C1206 SIZE (MILITARY CDR32)			
4,700	K,M	C1206N472(3)1X(4)C	CDR32BX472B(3)W(4)
5,600	K,M	C1206N562(3)1X(4)C	CDR32BX562B(3)W(4)
6,800	K,M	C1206N682(3)1X(4)C	CDR32BX682B(3)W(4)
8,200	K,M	C1206N822(3)1X(4)C	CDR32BX822B(3)W(4)
10,000	K,M	C1206N103(3)1X(4)C	CDR32BX103B(3)W(4)
12,000	K,M	C1206N123(3)1X(4)C	CDR32BX123B(3)W(4)
15,000	K,M	C1206N153(3)1X(4)C	CDR32BX153B(3)W(4)
50 Volt — BX — C1206 SIZE (MILITARY CDR32)			
18,000	K,M	C1206N183(3)5X(4)C	CDR32BX183A(3)W(4)
22,000	K,M	C1206N223(3)5X(4)C	CDR32BX223A(3)W(4)
27,000	K,M	C1206N273(3)5X(4)C	CDR32BX273A(3)W(4)
33,000	K,M	C1206N333(3)5X(4)C	CDR32BX333A(3)W(4)
39,000	K,M	C1206N393(3)5X(4)C	CDR32BX393A(3)W(4)

- (1) To complete Part Number for Dielectric, insert P or X symbol – as defined by Military specification.
- (2) To complete Part Number for Dielectric, insert G or X symbol. (“G” for Military “BP,” or “X” for Military “BX.”)
- (3) To complete Part Number, insert Capacitance Tolerance Symbol (when applicable) as available in MIL-PRF-55681: B – ±0.1 pF, C – ±0.25 pF, D – ±0.5pF, F – ±1%, J – ±5%, K – ±10%, M – ±20%. **NOTE: Available tolerances are listed in columns above.**
- (4) To complete Part Number, insert Failure Rate Symbol: M –1.0%; P –0.1%; R –0.01%; S –.001%.

Note: All MIL-PRF-55681 and KEMET Part Numbers tabulated above assume use of Solderguard II (MIL-PRF-55681 “W”; KEMET “C”) end metalization. If MIL-PRF-55681 “U” or “S” (KEMET “H”) or MIL-PRF-55681 “Y” (KEMET “C”) is required, please change designators accordingly.

KEMET TANTALUM AND ALUMINUM CHIP CAPACITORS

CHARGED™

Packaging Information

Tape & Reel Packaging

KEMET's Molded Tantalum and Aluminum Chip Capacitor families are packaged in 8 mm and 12 mm plastic tape on 7" and 13" reels, in accordance with EIA Standard 481-1: Taping of Surface Mount Components for Automatic Handling. This packaging system is compatible with all tape fed automatic pick and place systems.

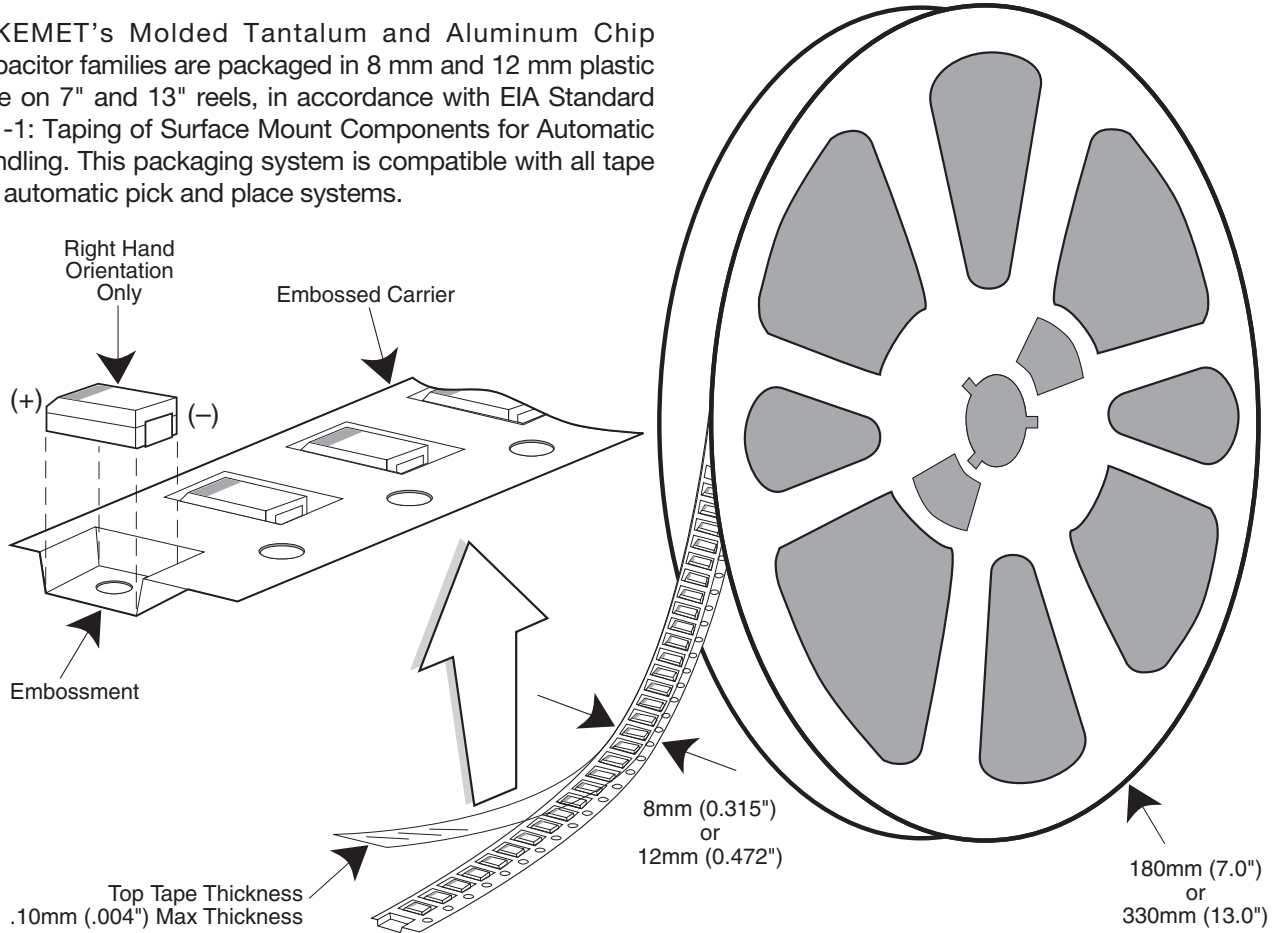

Labeling: Bar code labeling (standard or custom) shall be on the side of the reel opposite the sprocket holes. Refer to EIA-556.

QUANTITIES PACKAGED PER REEL

Case Code		Tape Width-mm	7" Reel*	13" Reel*
KEMET	EIA			
R	2012-12	8	2,500	10,000
S	3216-12	8	2,500	10,000
T	3528-12	8	2,500	10,000
U	6032-15	12	1,000	5,000
W	7343-15	12	1,000	3,000
V	7343-20	12	1,000	3,000
A	3216-18	8	2,000	9,000
B	3528-21	8	2,000	8,000
C	6032-28	12	500	3,000
D	7343-31	12	500	2,500
Y	7343-40	12	500	2,000
X	7343-43	12	500	2,000
E	7260-38	12	500	2,000

* No c-spec required for 7" reel packaging. C-7280 required for 13" reel packaging.

CERAMIC CHIP CAPACITORS

Packaging Information



Tape & Reel Packaging

KEMET offers Multilayer Ceramic Chip Capacitors packaged in 8mm and 12mm plastic tape on 7" and 13" reels in accordance with EIA standard 481-1: Taping of surface mount components for automatic handling. This packaging system is compatible with all tape fed automatic pick and place systems. See page 78 for details on reeling quantities for commercial chips and page 87 for MIL-PRF-55681 chips.

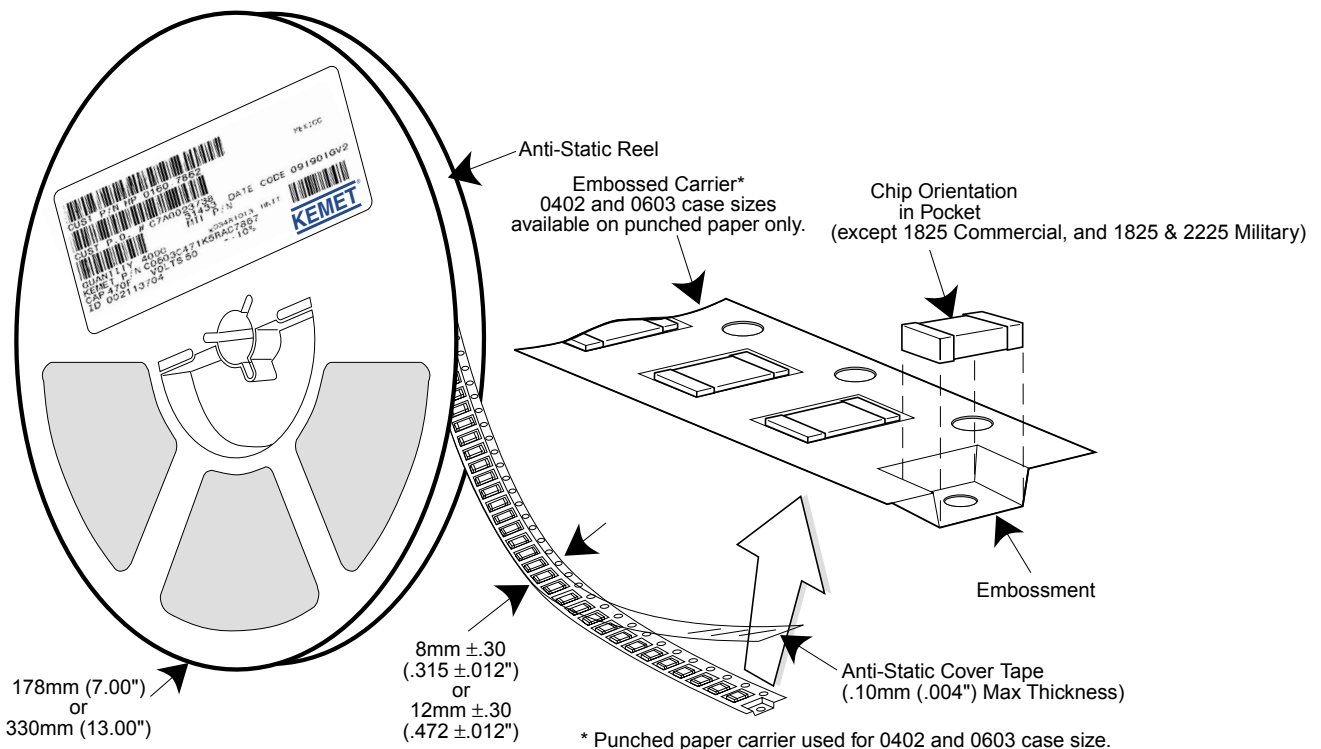

SURFACE MOUNT LAND DIMENSIONS - CERAMIC CHIP CAPACITORS - MM

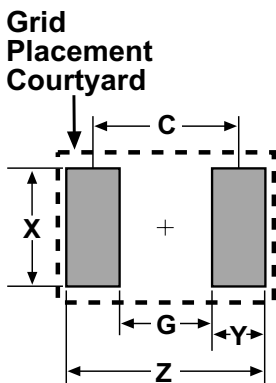

Dimension	Reflow Solder					Wave Solder				
	Z	G	X	Y(ref)	C(ref)	Z	G	X	Y(ref)	Smin
0402	2.14	0.28	0.74	0.93	1.21	Not Recommended				
0603	2.78	0.68	1.08	1.05	1.73	3.18	0.68	0.80	1.25	1.93
0805	3.30	0.70	1.60	1.30	2.00	3.70	0.70	1.10	1.50	2.20
1206	4.50	1.50	2.00	1.50	3.00	4.90	1.50	1.40	1.70	3.20
1210	4.50	1.50	2.90	1.50	3.00	4.90	1.50	2.00	1.70	3.20
1812	5.90	2.30	3.70	1.80	4.10	Not Recommended				
1825	5.90	2.30	6.90	1.80	4.10					
2220	7.00	3.30	5.50	1.85	5.15					
2225	7.00	3.30	6.80	1.85	5.15					

Calculation Formula
 $Z = Lmin + 2Jt + Tt$
 $G = Smax - 2Jh - Th$
 $X = Wmin + 2Js + Ts$
 Tt, Th, Ts = Combined tolerances

TANTALUM, CERAMIC AND ALUMINUM CHIP CAPACITORS

Packaging Information

Performance Notes

- Cover Tape Break Force:** 1.0 Kg Minimum.
- Cover Tape Peel Strength:** The total peel strength of the cover tape from the carrier tape shall be:

Tape Width	Peel Strength
8 mm	0.1 Newton to 1.0 Newton (10g to 100g)
12 mm	0.1 Newton to 1.3 Newton (10g to 130g)

The direction of the pull shall be opposite the direction of the carrier tape travel. The pull angle of the carrier tape shall be 165° to 180° from the plane of the carrier tape. During peeling, the carrier and/or cover tape shall be pulled at a velocity of 300 ±10 mm/minute.

- Reel Sizes:** Molded tantalum capacitors are available on either 180 mm (7") reels (standard) or 330 mm (13") reels (with C-7280). Note that 13" reels are preferred.
- Labeling:** Bar code labeling (standard or custom) shall be on the side of the reel opposite the sprocket holes. Refer to EIA-556.

Embossed Carrier Tape Configuration: Figure 1

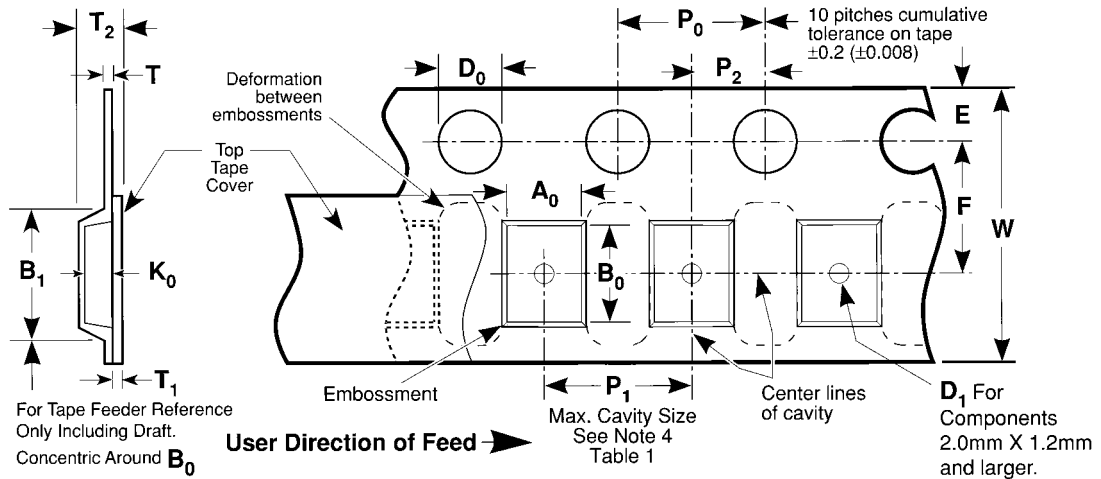

Table 1 — EMBOSSED TAPE DIMENSIONS (Metric will govern)

Constant Dimensions — Millimeters (Inches)									
Tape Size	D ₀	E	P ₀	P ₂	T Max	T ₁ Max			
8 mm and 12 mm	1.5 +0.10 -0.0 (0.059 +0.004, -0.0)	1.75 ±0.10 (0.069 ±0.004)	4.0 ±0.10 (0.157 ±0.004)	2.0 ±0.05 (0.079 ±0.002)	0.600 (0.024)	0.100 (0.004)			
Variable Dimensions — Millimeters (Inches)									
Tape Size	Pitch	B ₁ Max. Note 1	D ₁ Min. Note 2	F	P ₁	R Min. Note 3	T ₂ Max	W	A ₀ B ₀ K ₀ Note 4
8 mm	Single (4 mm)	4.4 (0.173)	1.0 (0.039)	3.5 ±0.05 (0.138 ±0.002)	4.0 ±0.10 (0.157 ±0.004)	25.0 (0.984)	2.5 (0.098)	8.0 ±0.30 (.315 ±0.012)	
12 mm	Double (8 mm)	8.2 (0.323)	1.5 (0.059)	5.5 ±0.05 (0.217 ±0.002)	8.0 ±0.10 (0.315 ±0.004)	30.0 (1.181)	4.6 (0.181)	12.0 ±0.30 (0.472 ±0.012)	

NOTES

- B₁ dimension is a reference dimension for tape feeder clearance only.
- The embossment hole location shall be measured from the sprocket hole controlling the location of the embossment. Dimensions of embossment location and hole location shall be applied independent of each other.
- Tape with components shall pass around radius "R" without damage (see sketch A). The minimum trailer length (Fig. 2) may require additional length to provide R min. for 12 mm embossed tape for reels with hub diameters approaching N min. (Table 2)
- The cavity defined by A₀, B₀, and K₀ shall be configured to surround the part with sufficient clearance such that the chip does not protrude beyond the sealing plane of the cover tape, the chip can be removed from the cavity in a vertical direction without mechanical restriction, rotation of the chip is limited to 20 degrees maximum in all 3 planes, and lateral movement of the chip is restricted to 0.5 mm maximum in the pocket (not applicable to vertical clearance.)

TANTALUM, CERAMIC AND ALUMINUM CHIP CAPACITORS

Packaging Information



Embossed Carrier Tape Configuration (cont.)

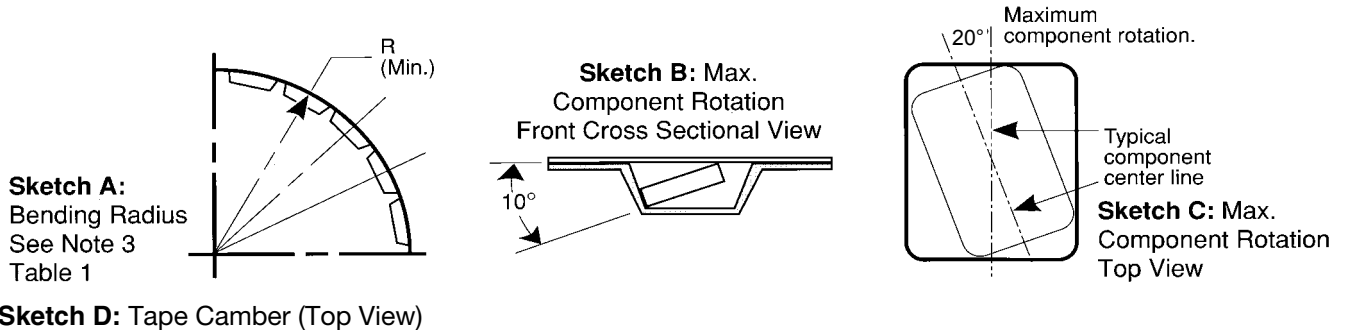

Sketch D: Tape Camber (Top View)

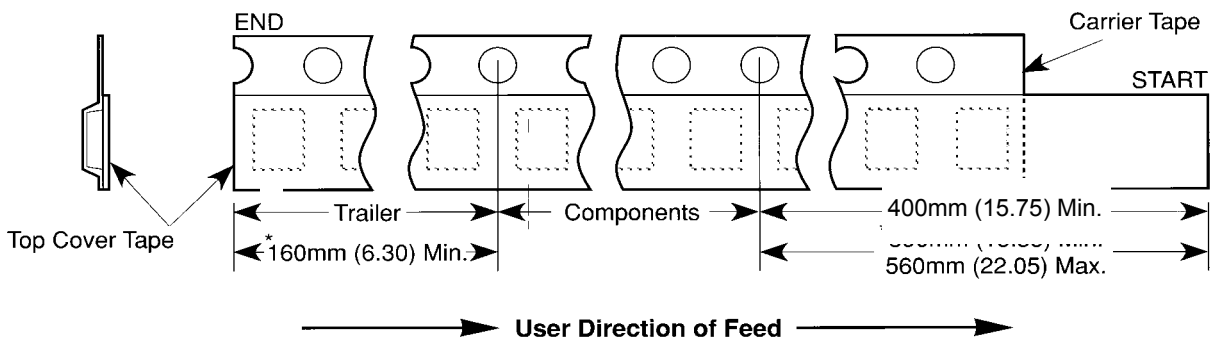
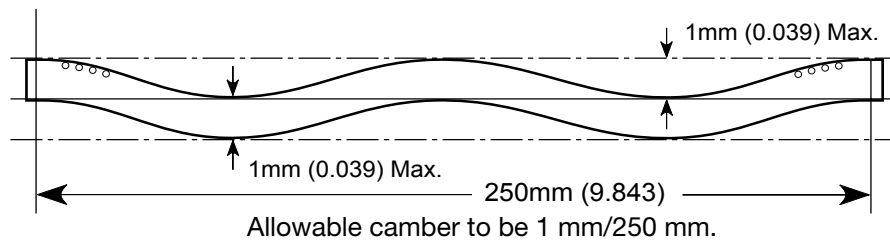

Figure 2: Tape Leader & Trailer Dimensions (Metric Dimensions Will Govern)

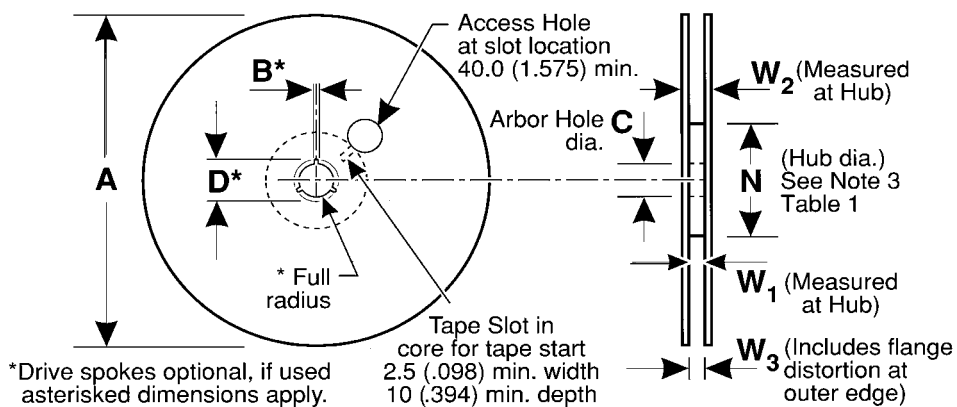

Figure 3: Reel Dimensions (Metric Dimensions will govern)

Table 2 – REEL DIMENSIONS (Metric will govern)

Tape Size	A Max	B* Min	C	D* Min	N Min	W ₁	W ₂ Max	W ₃
8 mm	330.0 (12.992)	1.5 (0.059)	13.0 ± 0.20 (0.512 ± 0.008)	20.2 (0.795)	50.0 (1.969) See Note 3	8.4 +1.5, -0.0 (0.331) +0.059, -0.0	14.4 (0.567)	7.9 Min (0.311) 10.9 Max (0.429)
12 mm	330.0 (12.992)	1.5 (0.059)	13.0 ± 0.20 (0.512 ± 0.008)	20.2 (0.795)	Table 1	12.4 +2.0, -0.0 (0.488) +0.078, -0.0	18.4 (0.724)	11.9 Min (0.469) 15.4 Max (0.606)

Punched Carrier (Paper Tape) Configuration (Ceramic Chips Only):

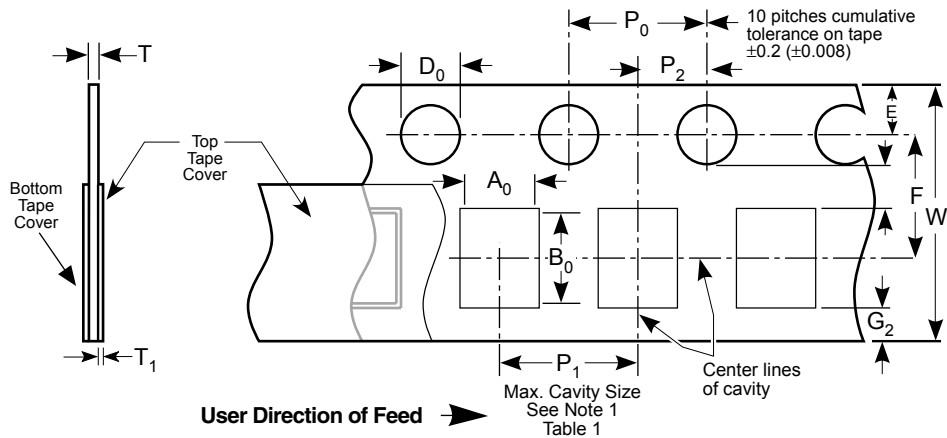

Table 1: 8 & 12mm Punched Tape
(Metric Dimensions Will Govern)

Constant Dimensions - Millimeters (Inches)

Tape Size	D ₀	E	P ₀	P ₂	T ₁	G ₁	G ₂	R Min.
8mm and 12mm	1.5 +0.10, -0.0 (.059 +0.004, -0.0)	1.75 ± 0.10 (.069 ± 0.004)	4.0 ± 0.10 (.157 ± 0.004)	2.0 ± 0.05 (.079 ± 0.002)	0.10 (.004) Max.	0.75 (.030) Min.	0.75 (.030) Min.	25 (.984) See Note 2 Table 1

Table 1: 8 & 12mm Punched Tape
(Metric Dimensions Will Govern)

Variable Dimensions - Millimeters (Inches)

Tape Size	P ₁	F	W	A ₀ B ₀	T
8mm 1/2 Pitch	2.0 ± 0.10 (.079 ± .004) See Requirements Section 3.3 (d)	3.5 ± 0.05 (.138 ± .002)	8.0 ± 0.3 (.315 ± 0.012)	See Note 1 Table 1	1.1mm (.043) Max. for Paper Base Tape and 1.6mm (.063) Max. for Non- Paper Base Compositions. See Note 3.
8mm	4.0 ± 0.10 (0.157 ± .004)				
12mm	4.0 ± 0.10 (0.157 ± .004)	5.5 ± 0.05	12.0 ± 0.3		
12mm Double Pitch	8.0 ± 0.10 (0.315 ± .004)	(.217 ± .002)	(.472 ± .012)		

Note:

1. A₀, B₀ and T determined by the maximum dimensions to the ends of the terminals extending from the body and/or the body dimensions of the component. The clearance between the ends of the terminals or body of the component to the sides and depth of the cavity (A₀, B₀ and T) must be within 0.05mm (.002) minimum and 0.50mm (.020) maximum. The clearance allowed must also prevent rotation of the component within the cavity of not more than 20 degrees (see sketches A and B).
2. Tape with components shall pass around radius "R" without damage.
3. KEMET nominal thicknesses are: 0402 = 0.6mm and all others 0.95mm minimum.

Sketch A:
Bending Radius
See Note 2
Table 1

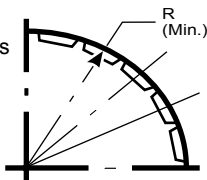

Sketch B:
Max. Component
Rotation - Front
Cross Sectional View

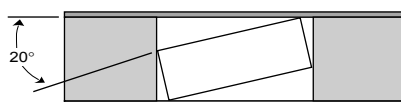

Sketch C:
Component Rotation - Top View

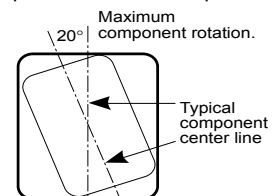

CERAMIC CHIP CAPACITORS

Packaging Information



Bulk Cassette Packaging (Ceramic Chips only) (Meets Dimensional Requirements IEC-286-6 and EIAJ 7201)

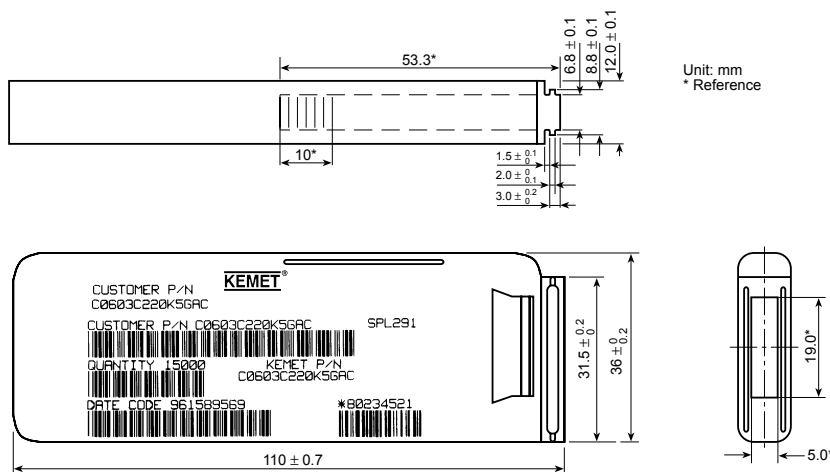

Table 2 – Capacitance Values Available In Bulk Cassette Packaging

Case Size	Dielectric	Voltage	Min. Cap Value	Max. Cap Value
0402	All	All	All	All
0603	All	All	All	All
0805	C0G	200	109	181
		100	109	331
		50	109	102
0805	X7R	200	221	392
		100	221	103
		50	221	273
		25	221	104
		16	221	104
0805	Y5V	25	104	224
		16	104	224

Table 1 – Capacitor Dimensions for Bulk Cassette Packaging – Millimeters

Metric Size Code	EIA Size Code	Length L	Width W	Thickness T	Bandwidth B	Minimum Separation S	Number of Pcs/Cassette
1005	0402	1.0 ± 0.05	0.5 ± 0.05	0.5 ± .05	0.2 to 0.4	0.3	50,000
1608	0603	1.6 ± 0.07	0.8 ± 0.07	0.8 ± .07	0.2 to 0.5	0.7	15,000
2012	0805	2.0 ± 0.10	1.25 ± 0.10	0.6 ± .10	0.5 to 0.75	0.75	10,000

Terminations: KEMET nickel barrier layer with a tin overplate.

CAPACITOR MARKING TABLE (Marking Optional - Not Available for 0402 Size or Y5V Dielectric)

Alpha Character	Numerical	Capacitance (pF) For Various Numerical Identifiers							
		9	0	1	2	3	4	5	6
A	0.10	1.0	10	100	1000	10,000	100,000	1,000,000	10,000,000
B	0.11	1.1	11	110	1100	11,000	110,000	1,100,000	11,000,000
C	0.12	1.2	12	120	1200	12,000	120,000	1,200,000	12,000,000
D	0.13	1.3	13	130	1300	13,000	130,000	1,300,000	13,000,000
E	0.15	1.5	15	150	1500	15,000	150,000	1,500,000	15,000,000
F	0.16	1.6	16	160	1600	16,000	160,000	1,600,000	16,000,000
G	0.18	1.8	18	180	1800	18,000	180,000	1,800,000	18,000,000
H	0.20	2.0	20	200	2000	20,000	200,000	2,000,000	20,000,000
J	0.22	2.2	22	220	2200	22,000	220,000	2,200,000	22,000,000
K	0.24	2.4	24	240	2400	24,000	240,000	2,400,000	24,000,000
L	0.27	2.7	27	270	2700	27,000	270,000	2,700,000	27,000,000
M	0.30	3.0	30	300	3000	30,000	300,000	3,000,000	30,000,000
N	0.33	3.3	33	330	3300	33,000	330,000	3,300,000	33,000,000
P	0.36	3.6	36	360	3600	36,000	360,000	3,600,000	36,000,000
Q	0.39	3.9	39	390	3900	39,000	390,000	3,900,000	39,000,000
R	0.43	4.3	43	430	4300	43,000	430,000	4,300,000	43,000,000
S	0.47	4.7	47	470	4700	47,000	470,000	4,700,000	47,000,000
T	0.51	5.1	51	510	5100	51,000	510,000	5,100,000	51,000,000
U	0.56	5.6	56	560	5600	56,000	560,000	5,600,000	56,000,000
V	0.62	6.2	62	620	6200	62,000	620,000	6,200,000	62,000,000
W	0.68	6.8	68	680	6800	68,000	680,000	6,800,000	68,000,000
X	0.75	7.5	75	750	7500	75,000	750,000	7,500,000	75,000,000
Y	0.82	8.2	82	820	8200	82,000	820,000	8,200,000	82,000,000
Z	0.91	9.1	91	910	9100	91,000	910,000	9,100,000	91,000,000
a	0.25	2.5	25	250	2500	25,000	250,000	2,500,000	25,000,000
b	0.35	3.5	35	350	3500	35,000	350,000	3,500,000	35,000,000
d	0.40	4.0	40	400	4000	40,000	400,000	4,000,000	40,000,000
e	0.45	4.5	45	450	4500	45,000	450,000	4,500,000	45,000,000
f	0.50	5.0	50	500	5000	50,000	500,000	5,000,000	50,000,000
m	0.60	6.0	60	600	6000	60,000	600,000	6,000,000	60,000,000
n	0.70	7.0	70	700	7000	70,000	700,000	7,000,000	70,000,000
t	0.80	8.0	80	800	8000	80,000	800,000	8,000,000	80,000,000
y	0.90	9.0	90	900	9000	90,000	900,000	9,000,000	90,000,000

Laser marking is available as an extra-cost option for most KEMET ceramic chips. Such marking is two sided, and includes a \bar{K} to identify KEMET, followed by two characters (per EIA-198 - see table below) to identify the capacitance value. Note that marking is not available for size 0402 nor for any Y5V chip. In addition, the 0603 marking option is limited to the \bar{K} only.

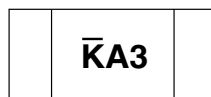

Example shown is 1,000 pF capacitor.



World Sales Headquarters
KEMET Electronics Corporation
P.O. Box 5928
Greenville, SC 29606
Phone: 864-963-6300

Europe
KEMET Electronics S.A.
1-3, Avenue de la Paix
P.O.B. 76
CH-1211 Geneva 20,
Switzerland
Phone: 41-22-715-0100

Asia
KEMET Electronics Marketing PTE Ltd.
101 Thomson road, #23-03
United Square
Singapore, 307591, Singapore
Phone: 65-6353-6636

KEMET Electronics Asia Ltd.
30 Canton Road, Room 1512
SilverCord Tower II
Tsimshatshui, Kowloon
Hong Kong
Phone: 852-2305-1168

KEMET reserves the right to modify minor details of internal and external construction at any time in the interest of product improvement. KEMET does not assume any responsibility for infringement that might result from the use of KEMET capacitors in potential circuit designs.