

DWG. NO.
SD-54363-038

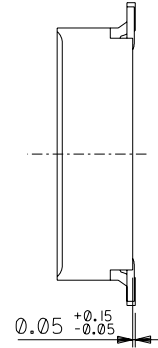

注記
NOTES:

1. 材質
MATERIAL
ハウジング: LCP (液晶ポリマー)、ガラス充填、黒色、UL 94V-0
HOUSING: LCP (LIQUID CRYSTAL POLYMER), GLASS FILLED, BLACK, UL 94V-0
ターミナル: 銅合金 (t=0.15)
TERMINAL: COPPER ALLOY (t=0.15)
ネイル: 銅合金 (t=0.2)
NAIL: COPPER ALLOY (t=0.2)
2. メッキ仕様
PLATING
ターミナル
TERMINAL
接点部: 金メッキ 0.25マイクロメートル以上
CONTACT AREA: GOLD 0.25 MICROMETER MINIMUM
半田付け部: 金メッキ 0.4マイクロメートル以下
SOLDER TAIL AREA: GOLD 0.4 MICROMETER MAXIMUM
下地メッキ: ニッケルメッキ 1.5マイクロメートル以上
UNDER PLATING: NICKEL 1.5 MICROMETER MINIMUM
ネイル
NAIL
鍍メッキ 3.0マイクロメートル以上
Sn 3.0 MICROMETER MINIMUM
下地メッキ: ニッケルメッキ 1.0マイクロメートル以上
UNDER PLATING: Ni 1.0 MICROMETER MINIMUM
3. テール平坦度は、0.08ミリメートル以下。テールとネイルを併せた平坦度は、0.1ミリメートル以下。
TAIL COPLANARITY TO BE 0.08 MAXIMUM. TAILS AND NAILS COPLANARITY TO BE 0.1 MAXIMUM.
4. 嵌合相手: 55299-**** (H=3mm)
55201-****, 55650-**** (H=2mm)
MATED CONN.: 55299-**** (H=3mm)
55201-****, 55650-**** (H=2mm)
5. この製品は54363-**01, (エンボス梱包品 54363-**08) の鉛フリー品です。
THIS PRODUCT IS 'LEAD FREE' OF 54363-**01, (EMBOSSSED TAPE PKG 54363-**08)

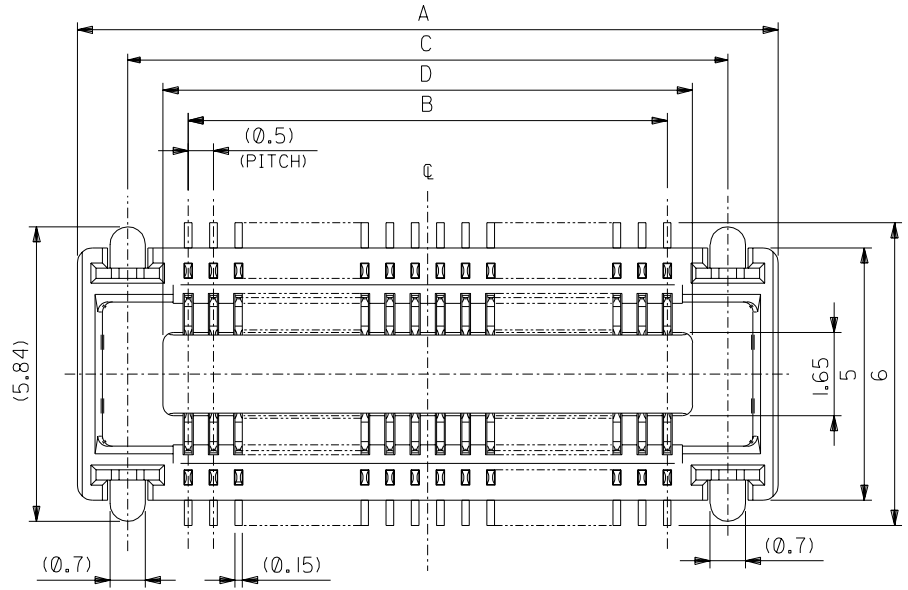
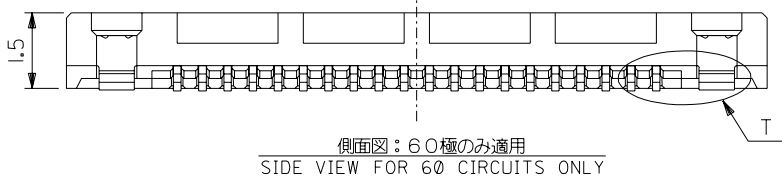
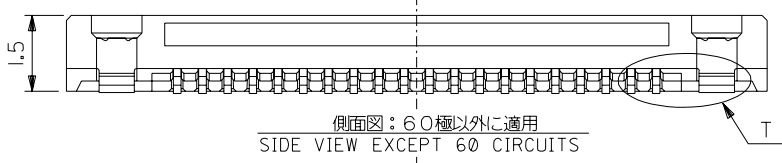

40.5	41.9	39.5	43.9	54363-1678	54363-1671	160	—
35.5	36.9	34.5	38.9	54363-1478	54363-1471	140	○
30.5	31.9	29.5	33.9	54363-1278	54363-1271	120	○
28	29.4	27	31.4	54363-1178	54363-1171	110	○
25.5	26.9	24.5	28.9	54363-1078	54363-1071	100	○
23	24.4	22	26.4	54363-0978	54363-0971	90	—
20.5	21.9	19.5	23.9	54363-0878	54363-0871	80	○
18	19.4	17	21.4	54363-0778	54363-0771	70	○
15.5	16.9	14.5	18.9	54363-0678	54363-0671	60	○
13	14.4	12	16.4	54363-0578	54363-0571	50	○
10.5	11.9	9.5	13.9	54363-0478	54363-0471	40	○
8	9.4	7	11.4	54363-0378	54363-0371	30	○
5.5	6.9	4.5	8.9	54363-0278	54363-0271	20	○

D	C	B	A	エンボス梱包品 EMBOSSSED TAPE PACKAGING	製品番号 MATERIAL NO.	極数 CIRCUITS	量産対応 AVAILABLE

DO NOT SCALE DRAWING

EC NO. DRWN: CHK: APPR:	EC NO. DRWN: CHK: APPR:	EC NO. DRWN: CHK: APPR:	REVISED ECNNO. J2004-2225 DRWN: A.IDA '04/02/02 CHK: H.TAKASE APPR: J.MIYAZAWA/YO.ITO	RELEASED ECNNO. J2004-1740 DRWN: A.IDA '04/01/06 CHK: H.TAKASE APPR: J.MIYAZAWA/YO.ITO	MATERIAL 材料 注記参照 SEE NOTES	FINISH 仕上げ 注記参照 SEE NOTES	WIRE RANGE 適用層線範囲	INS. RANGE 被覆外径
			A	0				

GENERAL TOLERANCES: (UNLESS SPECIFIED) 一般公差	SCALE 10-1	DESIGN UNITS <input checked="" type="checkbox"/> mm <input type="checkbox"/> INCH	THIRD ANGLE PROJECTION <input type="checkbox"/> mm <input type="checkbox"/> INCH <input checked="" type="checkbox"/> mm ONLY	SHT REV	REVISE ON CAD ONLY
10 UNDER 未満	±0.2	DRAWN BY & DATE A. Iida '04/01/06	TITLE: 0.5 mm PITCH B/B CONN. REC. HOUSING ASS'Y (H=2,3mm) WITH FITTING NAIL -LEAD FREE-		
10 OVER 以上	±0.25	CHECKED BY & DATE R. Takase '04/01/06			
30 OVER 以上	±0.3	APPROVED BY & DATE J. Mizuno / Y. Ito '04/01/06	MOLEX MOLEX INCORPORATED		
ANGLE 角度	±3°	CAD FILENAME SD-54363-038.S01	MATERIAL NO. SEE CHART	DRAWING NO. SD-54363-038	SHEET NO. 1 OF 2
THIS DRAWING CONTAINS INFORMATION THAT IS PROPRIETARY TO MOLEX INCORPORATED AND SHOULD NOT BE USED WITHOUT WRITTEN PERMISSION.					SIZE B

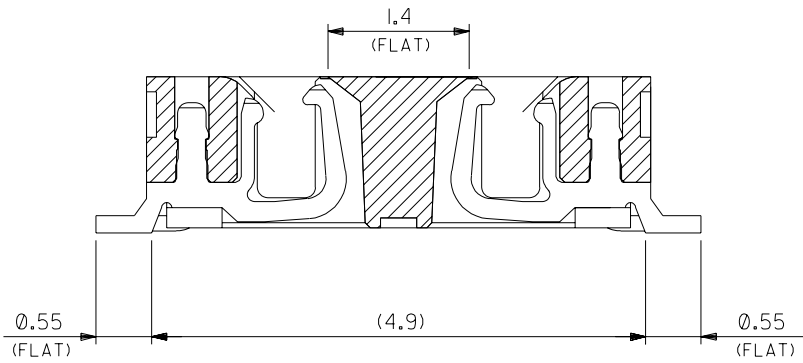

製品断面図 (半田付け部 吸着面寸法)
DETAIL FOR SOLDERING AND VACUUM AREA

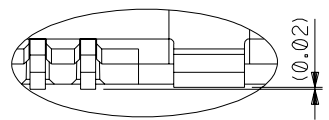

T部詳細
DETAIL T

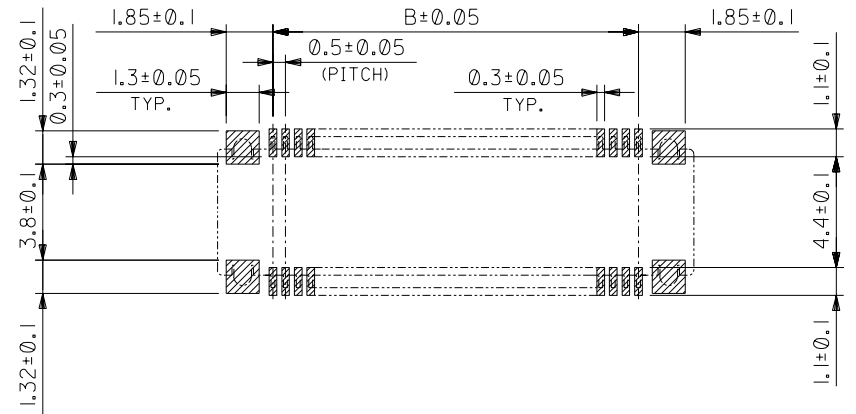

推奨基板寸法
RECOMMENDED PCB PATTERN LAYOUT
(SCALE:5-1)

DO NOT SCALE DRAWING

EC NO. DRAWN: CHK'g: APPR:	EC NO. DRAWN: CHK'g: APPR:	EC NO. DRAWN: CHK'g: APPR:	EC NO. DRAWN: CHK'g: APPR:	SEE SHEET 1 OF 2 EC NO. DRAWN: CHK'g: APPR:	DESCRIPTION	MATERIAL 材料	注記参照 SEE NOTES	GENERAL TOLERANCES: (UNLESS SPECIFIED) 一般公差	SCALE 20-1	DESIGN UNITS <input checked="" type="checkbox"/> mm <input type="checkbox"/> INCH	THIRD ANGLE PROJECTION	DIMENSIONS:		SHT	REV
						FINISH 仕上り			注記参照 SEE NOTES	10 UNDER 未満		±0.2	<input type="checkbox"/> mm <input type="checkbox"/> INCH	<input checked="" type="checkbox"/> mm ONLY	REVISION ON CAD ONLY
					WIRE RANGE 適用電線範囲	— # —	10 OVER 30 UNDER 以上 未満	±0.25	DRAWN BY & DATE A. Iida '04/01/06	CHECKED BY & DATE R. Takase '04/01/06	MATERIAL NO. SEE CHART	DRAWING NO. SD-54363-038	SHEET NO. 2	SIZE B	
				INS. RANGE 被覆外径	— # —	30 OVER 以上	±0.3	APPROVED BY & DATE Y. Ota '04/01/06	TITLE: 0.5 mm PITCH B/B CONN. REC. HOUSING ASS'Y (H=2,3mm) WITH FITTING NAIL -LEAD FREE-						
				0	REV	ANGLE 角度	±3°	CAD FILENAME SD-54363-038.S02		MATERIAL NO. SEE CHART		DRAWING NO. SD-54363-038		SHEET NO. 2	SIZE B

THIS DRAWING CONTAINS INFORMATION THAT IS PROPRIETARY TO MOLEX INCORPORATED AND SHOULD NOT BE USED WITHOUT WRITTEN PERMISSION.