

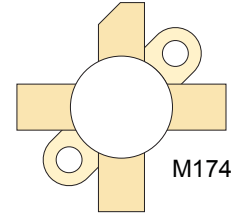

RF POWER VERTICAL MOSFET

The VRF152 is a gold-metallized silicon n-channel RF power transistor designed for broadband commercial and military applications requiring high power and gain without compromising reliability, ruggedness, or inter-modulation distortion.



FEATURES

- Improved Ruggedness $V_{(BR)DSS} = 130V$
- 150W with 22dB Typical Gain @ 30MHz, 50V
- 150W with 14dB Typical Gain @ 175MHz, 50V
- Excellent Stability & Low IMD
- Common Source Configuration
- Available in Matched Pairs
- 30:1 Load VSWR Capability at Specified Operating Conditions
- Nitride Passivated
- Refractory Gold Metallization
- Low Rds Replacement for MRF151/ BLF177/ SD2941
- RoHS Compliant 

Maximum Ratings

All Ratings: $T_c = 25^\circ C$ unless otherwise specified

Symbol	Parameter	VRF152(MP)	Unit
V_{DSS}	Drain-Source Voltage	130	V
I_D	Continuous Drain Current @ $T_c = 25^\circ C$	20	A
V_{GS}	Gate-Source Voltage	± 40	V
P_D	Total Device dissipation @ $T_c = 25^\circ C$	300	W
T_{STG}	Storage Temperature Range	-65 to 150	$^\circ C$
T_J	Operating Junction Temperature	200	

Static Electrical Characteristics

Symbol	Parameter	Min	Typ	Max	Unit
$V_{(BR)DSS}$	Drain-Source Breakdown Voltage ($V_{GS} = 0V, I_D = 50mA$)	130			V
$R_{DS(ON)}$	Drain-Source On-State Resistance ¹ ($V_{GS} = 10V, I_D = 10A$)		0.13	0.20	Ohms
I_{DSS}	Zero Gate Voltage Drain Current ($V_{DS} = 100V, V_{GS} = 0V$)			50	μA
I_{GSS}	Gate-Source Leakage Current ($V_{DS} = \pm 20V, V_{GS} = 0V$)			1.0	μA
g_{fs}	Forward Transconductance ($V_{DS} = 10V, I_D = 5A$)	5.0	6.2		mhos
$V_{GS(TH)}$	Gate Threshold Voltage ($V_{DS} = 10V, I_D = 100mA$)	2.9	3.6	4.4	V

Thermal Characteristics

Symbol	Characteristic	Min	Typ	Max	Unit
$R_{\theta JC}$	Junction to Case Thermal Resistance			0.60	$^\circ C/W$

 **CAUTION:** These Devices are Sensitive to Electrostatic Discharge. Proper Handling Procedures Should Be Followed.

Dynamic Characteristics

VRF152(MP)

Symbol	Parameter	Test Conditions	Min	Typ	Max	Unit
C_{ISS}	Input Capacitance	$V_{GS} = 0V$		383		pF
C_{OSS}	Output Capacitance	$V_{DS} = 50V$		215		
C_{RSS}	Reverse Transfer Capacitance	$f = 1MHz$		20		

Functional Characteristics

Symbol	Parameter	Min	Typ	Max	Unit
G_{PS}	$f_1 = 30MHz, f_2 = 30.001MHz, V_{DD} = 50V, I_{DQ} = 250mA, P_{out} = 150W_{PEP}$	18	22		dB
G_{PS}	$f = 175MHz, V_{DD} = 50V, I_{DQ} = 250mA, P_{out} = 150W$		14		
η_D	$f_1 = 30MHz, f_2 = 30.001MHz, V_{DD} = 50V, I_{DQ} = 250mA, P_{out} = 150W_{PEP}$		50		%
IMD _(d3)	$f_1 = 30MHz, f_2 = 30.001MHz, V_{DD} = 50V, I_{DQ} = 250mA, P_{out} = 150W_{PEP}^1$		-30		dBc
IMD _(d11)	$f_1 = 30MHz, f_2 = 30.001MHz, V_{DD} = 50V, I_{DQ} = 250mA, P_{out} = 150W_{PEP}$		-60		
Ψ	$f_1 = 30MHz, f_2 = 30.001MHz, V_{DD} = 50V, I_{DQ} = 250mA, P_{out} = 150W_{PEP}$ 30:1 VSWR - All Phase Angles	No Degradation in Output Power			

1. To MIL-STD-1311 Version A, test method 2204B, Two Tone, Reference Each Tone

Microsemi reserves the right to change, without notice, the specifications and information contained herein.

Typical Performance Curves

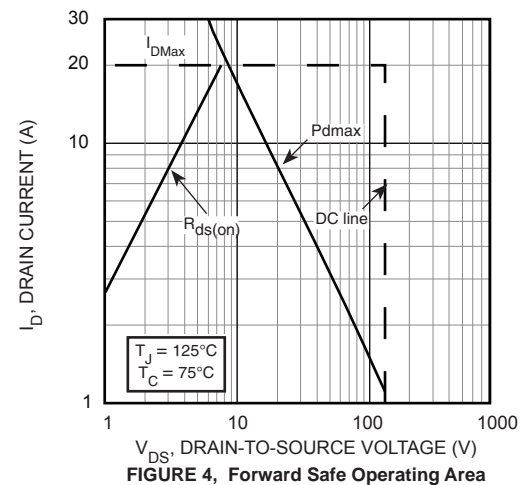
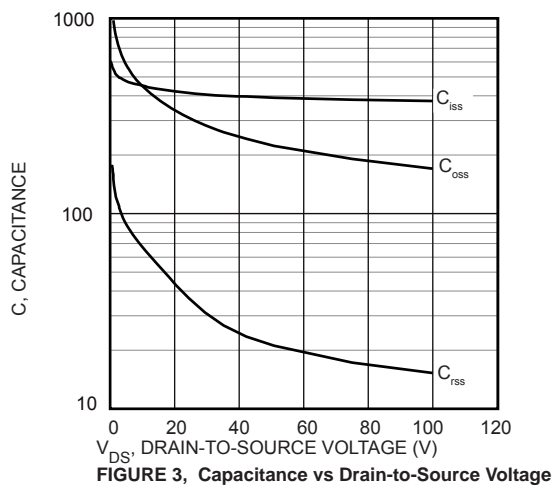
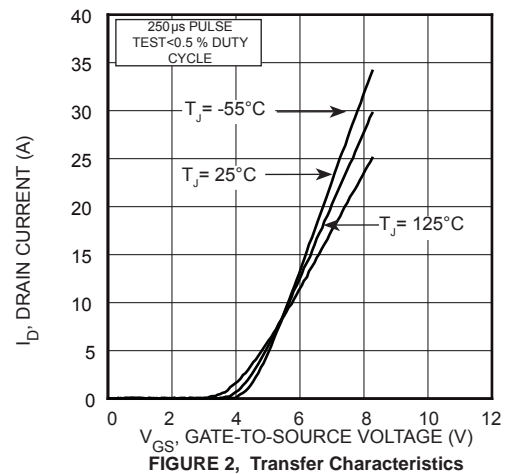
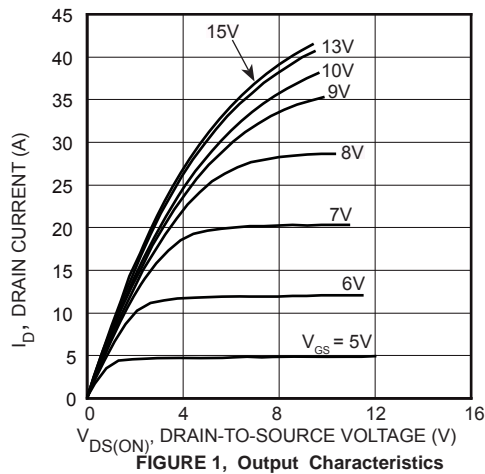

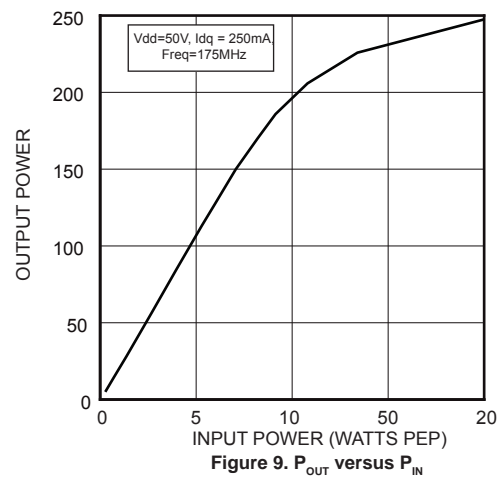
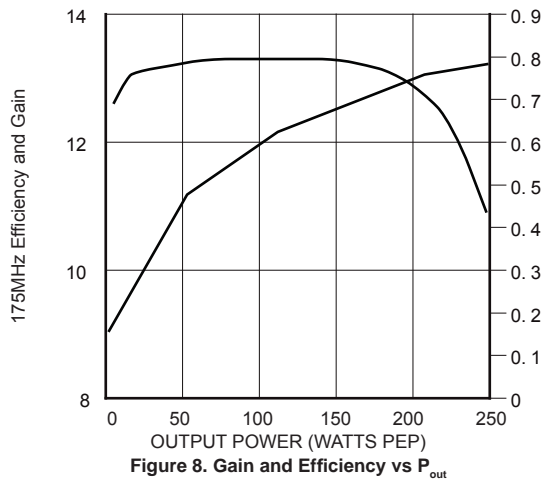
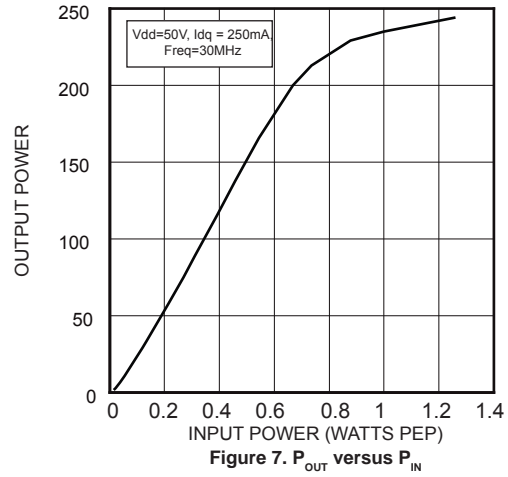
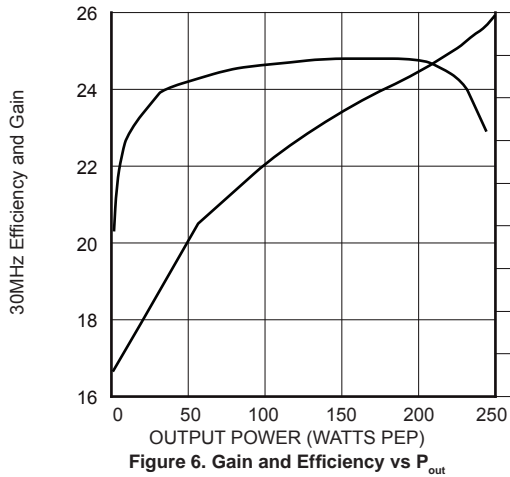
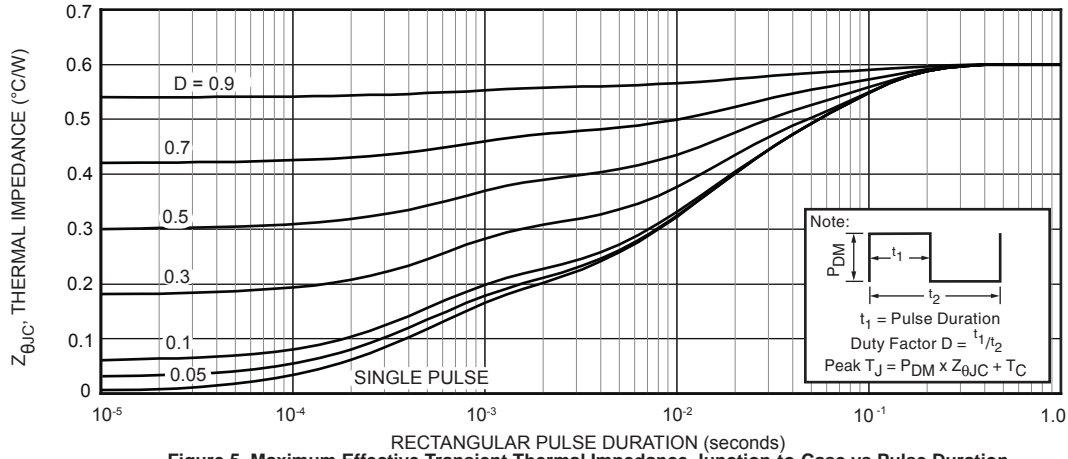

30 MHz test Circuit

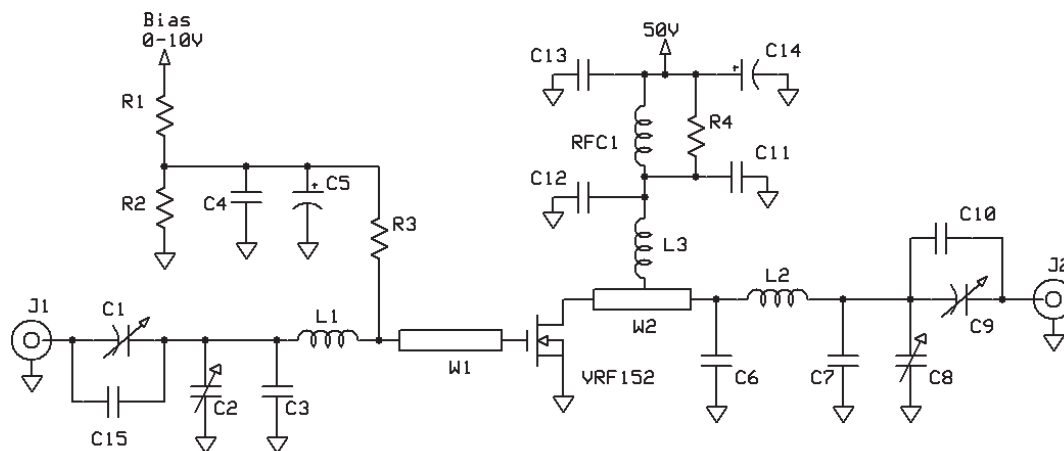

C1,2,8,9 - ARCO 463 20-180pF
 C3,7 - 120 pF ATC 100B
 C4,11-13 - 0.1uF 100V SMT
 C5 - 1 uF 15WV tant
 C6, C15 - 47pF ATC 100B
 C10 - 150pF ATC 100B
 C14 - 15uF 100V Elect
 W1 W2 - printed line 0.23"x 0.7"

L1 - 4t #20 ga .25"d x .16"L ~120nH
 L2 - 5t #14 ga .312" dia x .45" ~135nH
 L3 -7 turns #16 ga 5/16" ID tight. ~250nH
 R1 R2 - 2.2k ohm 1/4W
 R3 - 22 ohm 1W SMT
 R4 - 2.2 ohm 2W
 RFC1 Fair-Rite 2961666631 (VK200-4B)
 PCB = FR-4 fiberglass-epoxy er = 4.6

175 MHz test Circuit

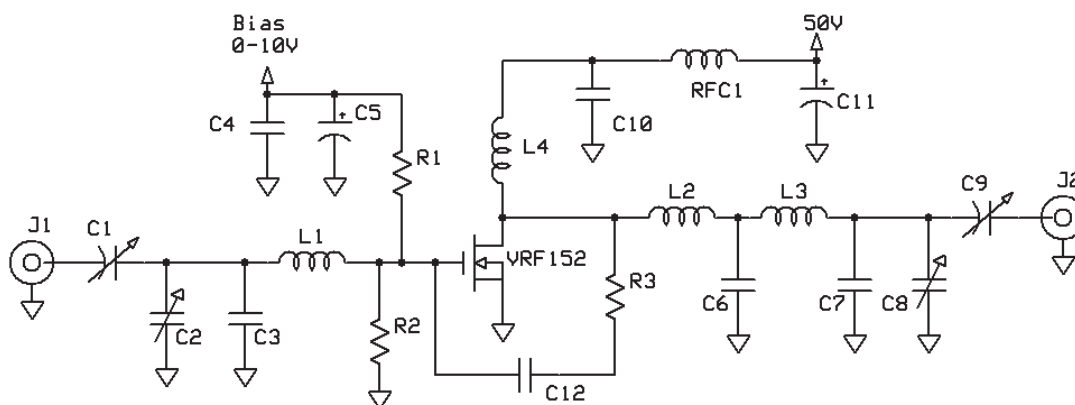

C1 C2 C8 - ARCO 463
 C3 C7 - 25 pF ATC 100B
 C4 C10 C12 - 0.1uF 100V SMT
 C5 - 1 uF 15WV tant
 C6 - 250 pF ATC 100B
 C9 - ARCO 462
 C11 - 15uF 100V Elect

L1 - 3/4" #18 ga into Hairpin
 L2 - printed line 0.2"W x 0.5" L
 L3 - 1" #16 ga into Hairpin
 L4 -2 turns #16 ga. 5/16" ID
 R1 R2 - 150 ohm 1W
 R3 - 470 ohm 3W, Panasonic ECG
 RFC1 Fair-Rite 2961666631 (VK200-4B)

Adding MP at the end of P/N specifies a matched pair where $V_{GS(TH)}$ is matched between the two parts. V_{TH} values are marked on the devices per the following table.

Code	Vth Range	Code 2	Vth Range
A	2.900 - 2.975	M	3.650 - 3.725
B	2.975 - 3.050	N	3.725 - 3.800
C	3.050 - 3.125	P	3.800 - 3.875
D	3.125 - 3.200	R	3.875 - 3.950
E	3.200 - 3.275	S	3.950 - 4.025
F	3.275 - 3.350	T	4.025 - 4.100
G	3.350 - 3.425	W	4.100 - 4.175
H	3.425 - 3.500	X	4.175 - 4.250
J	3.500 - 3.575	Y	4.250 - 4.325
K	3.575 - 3.650	Z	4.325 - 4.400

V_{TH} values are based on Microsemi measurements at datasheet conditions with an accuracy of 1.0%.

.5" SOE Package Outline
All Dimensions are ± .005

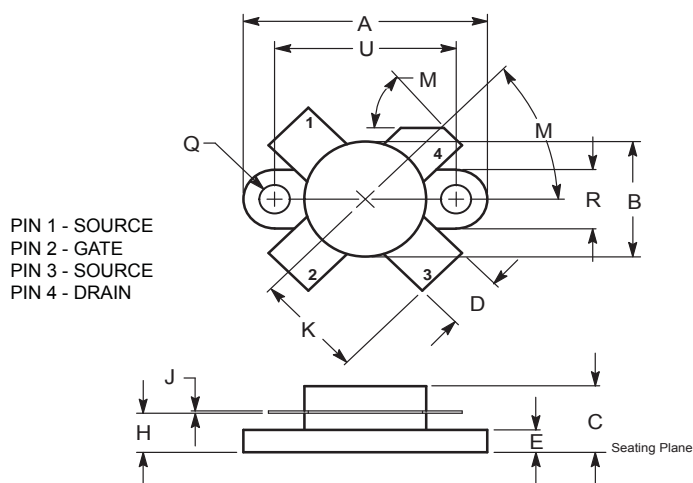

DIM	INCHES		MILLIMETERS	
	MIN	MAX	MIN	MAX
A	0.096	0.990	24.39	25.14
B	0.465	0.510	11.82	12.95
C	0.229	0.275	5.82	6.98
D	0.216	0.235	5.49	5.96
E	0.084	0.110	2.14	2.79
H	0.144	0.178	3.66	4.52
J	0.003	0.007	0.08	0.17
K	0.435		11.0	
M	45° NOM		45° NOM	
Q	0.115	0.130	2.93	3.30
R	0.246	0.255	6.25	6.47
U	0.720	0.730	18.29	18.54

Microsemi's products are covered by one or more of U.S. patents 4,895,810 5,045,903 5,089,434 5,182,234 5,019,522 5,262,336 6,503,786 5,256,583 4,748,103 5,283,202 5,231,474 5,434,095 5,528,058 6,939,743, 7,352,045 5,283,201 5,801,417 5,648,283 7,196,634 6,664,594 7,157,886 6,939,743 7,342,262 and foreign patents. US and Foreign patents pending. All Rights Reserved.