

U Interface Transformer (2B1Q Coding Applications)

Designed for use with National TP 3410

Turns Ratio (± 3 %) (Line : Chip)	1.50 : 1
-------------------------------------	----------

PARAMETER	MIN.	MAX.	UNITS
Primary Inductance (Line Side) Pins 4 to 2 with 1 & 5 shorted.	25.4	28.6	mH
Primary DC Resistance		20	ohms
Secondary DC Resistance		3.0	ohms
Isolation (Hi-Pot)	2000		V _{RMS}
DC Bias		60	mA
Return Loss 10KHz & 25 KHz	20		dB
Longitudinal Balance (281 Hz to 40 KHz)	55		dB

Flammability: Materials used in the production of these units meet requirements of UL94-VO and IEC 695-2-2 needle flame test.

*A Surface Mount Version of this part is available
add suffix "G" to part number*

NOTE:

Operating Temp. Range -40°C to +85°C

Primary is Line Side (Pins 1,2,4,5)
Secondary is Chip Side (Pins 7,8,9)

Surge Voltage Capability

Metallic Voltage: 800 V peak, 10/560 μS

Longitudinal Voltage: 2400 V peak, 10/700 μS

**Physical Dimensions
inches (mm)**

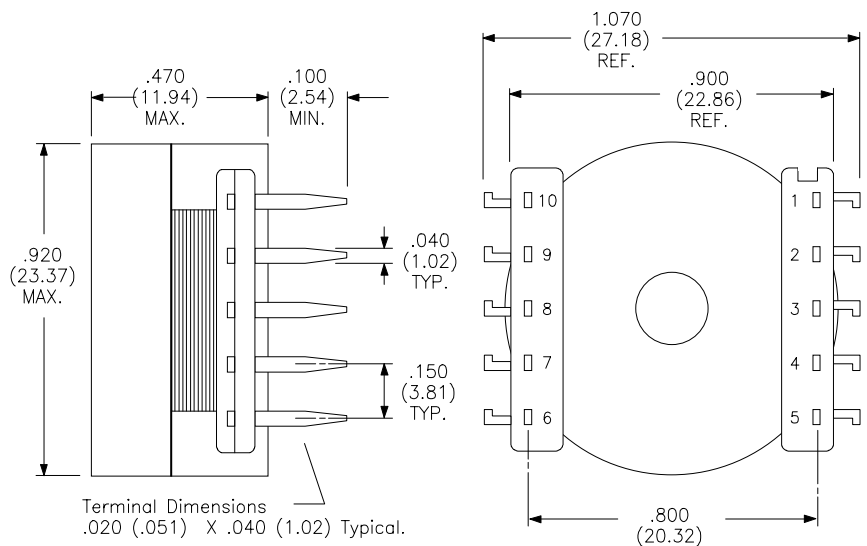

Schematic Diagram

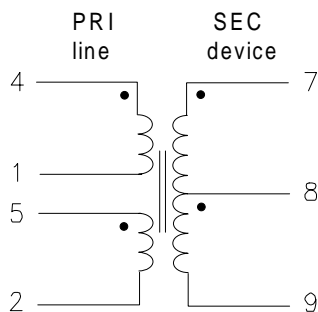

Notch Indicates Pin #1

RHOMBUS P/N: T-13211	
CUST P/N:	NAME:
DATE: 7/2/96	SHEET: 1 of 1