

MC33501, MC33503

1.0 V, Rail-to-Rail, Single Operational Amplifiers

The MC33501/503 operational amplifier provides rail-to-rail operation on both the input and output. The output can swing within 50 mV of each rail. This rail-to-rail operation enables the user to make full use of the entire supply voltage range available. It is designed to work at very low supply voltages (1.0 V and ground), yet can operate with a supply of up to 7.0 V and ground. Output current boosting techniques provide high output current capability while keeping the drain current of the amplifier to a minimum.

- Low Voltage, Single Supply Operation (1.0 V and Ground to 7.0 V and Ground)
- High Input Impedance: Typically 40 fA Input Bias Current
- Typical Unity Gain Bandwidth @ 5.0 V = 4.0 MHz, @ 1.0 V = 3.0 MHz
- High Output Current ($I_{SC} = 40 \text{ mA @ } 5.0 \text{ V}$, $13 \text{ mA @ } 1.0 \text{ V}$)
- Output Voltage Swings within 50 mV of Both Rails @ 1.0 V
- Input Voltage Range Includes Both Supply Rails
- High Voltage Gain: 100 dB Typical @ 1.0 V
- No Phase Reversal on the Output for Over-Driven Input Signals
- Input Offset Trimmed to 0.5 mV Typical
- Low Supply Current ($I_D = 1.2 \text{ mA/per Amplifier}$, Typical)
- 600 Ω Drive Capability
- Extended Operating Temperature Range (-40 to 105°C)

Applications

- Single Cell NiCd/Ni MH Powered Systems
- Interface to DSP
- Portable Communication Devices
- Low Voltage Active Filters
- Telephone Circuits
- Instrumentation Amplifiers
- Audio Applications
- Power Supply Monitor and Control
- Transistor Count: 98



ON Semiconductor™

<http://onsemi.com>

MARKING DIAGRAM



SOT23-5
(TSOP-5, SC59-5)
SN SUFFIX
CASE 483

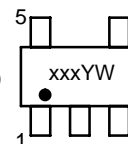

xxx = 501 or 503
Y = Year
W = Work Week

PIN CONNECTIONS

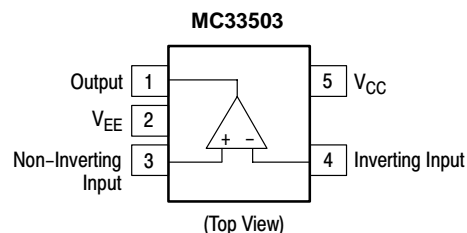
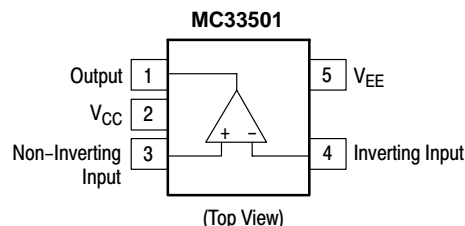

ORDERING INFORMATION

Device	Package	Shipping
MC33501SNT1	SOT23-5	3000 Tape & Reel
MC33503SNT1	SOT23-5	3000 Tape & Reel

MC33501, MC33503

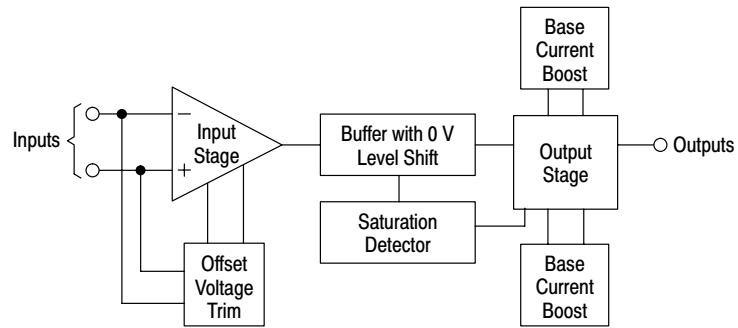

This device contains 98 active transistors per amplifier.

Figure 1. Simplified Block Diagram

MAXIMUM RATINGS

Rating	Symbol	Value	Unit
Supply Voltage (V_{CC} to V_{EE})	V_S	7.0	V
ESD Protection Voltage at any Pin Human Body Model	V_{ESD}	2000	V
Voltage at Any Device Pin	V_{DP}	$V_S \pm 0.3$	V
Input Differential Voltage Range	V_{IDR}	V_{CC} to V_{EE}	V
Common Mode Input Voltage Range	V_{CM}	V_{CC} to V_{EE}	V
Output Short Circuit Duration	t_S	Note 1	s
Maximum Junction Temperature	T_J	150	°C
Storage Temperature Range	T_{stg}	-65 to 150	°C
Maximum Power Dissipation	P_D	Note 1	mW

1. Power dissipation must be considered to ensure maximum junction temperature (T_J) is not exceeded.
2. ESD data available upon request.

MC33501, MC33503

DC ELECTRICAL CHARACTERISTICS ($V_{CC} = 5.0\text{ V}$, $V_{EE} = 0\text{ V}$, $V_{CM} = V_O = V_{CC}/2$, R_L to $V_{CC}/2$, $T_A = 25^\circ\text{C}$, unless otherwise noted.)

Characteristic	Symbol	Min	Typ	Max	Unit
Input Offset Voltage ($V_{CM} = 0$ to V_{CC}) $V_{CC} = 1.0\text{ V}$ $T_A = 25^\circ\text{C}$ $T_A = -40^\circ$ to 105°C $V_{CC} = 3.0\text{ V}$ $T_A = 25^\circ\text{C}$ $T_A = -40^\circ$ to 105°C $V_{CC} = 5.0\text{ V}$ $T_A = 25^\circ\text{C}$ $T_A = -40^\circ$ to 105°C	V_{IO}	-5.0 -7.0	0.5 -	5.0 7.0	mV
Input Offset Voltage Temperature Coefficient ($R_S = 50\ \Omega$) $T_A = -40^\circ$ to 105°C	$\Delta V_{IO}/\Delta T$	-	8.0	-	$\mu\text{V}/^\circ\text{C}$
Input Bias Current ($V_{CC} = 1.0$ to 5.0 V)	$ I_{IB} $	-	0.00004	1.0	nA
Common Mode Input Voltage Range	V_{ICR}	V_{EE}	-	V_{CC}	V
Large Signal Voltage Gain $V_{CC} = 1.0\text{ V}$ ($T_A = 25^\circ\text{C}$) $R_L = 10\text{ k}\Omega$ $R_L = 1.0\text{ k}\Omega$ $V_{CC} = 3.0\text{ V}$ ($T_A = 25^\circ\text{C}$) $R_L = 10\text{ k}\Omega$ $R_L = 1.0\text{ k}\Omega$ $V_{CC} = 5.0\text{ V}$ ($T_A = 25^\circ\text{C}$) $R_L = 10\text{ k}\Omega$ $R_L = 1.0\text{ k}\Omega$	A_{VOL}	25 5.0	100 50	- -	kV/V
Output Voltage Swing, High ($V_{ID} = \pm 0.2\text{ V}$) $V_{CC} = 1.0\text{ V}$ ($T_A = 25^\circ\text{C}$) $R_L = 10\text{ k}\Omega$ $R_L = 600\ \Omega$ $V_{CC} = 1.0\text{ V}$ ($T_A = -40^\circ$ to 105°C) $R_L = 10\text{ k}\Omega$ $R_L = 600\ \Omega$ $V_{CC} = 3.0\text{ V}$ ($T_A = 25^\circ\text{C}$) $R_L = 10\text{ k}\Omega$ $R_L = 600\ \Omega$ $V_{CC} = 3.0\text{ V}$ ($T_A = -40^\circ$ to 105°C) $R_L = 10\text{ k}\Omega$ $R_L = 600\ \Omega$ $V_{CC} = 5.0\text{ V}$ ($T_A = 25^\circ\text{C}$) $R_L = 10\text{ k}\Omega$ $R_L = 600\ \Omega$ $V_{CC} = 5.0\text{ V}$ ($T_A = -40^\circ$ to 105°C) $R_L = 10\text{ k}\Omega$ $R_L = 600\ \Omega$	V_{OH}	0.9 0.85	0.95 0.88	- -	V

MC33501, MC33503

DC ELECTRICAL CHARACTERISTICS (continued) ($V_{CC} = 5.0\text{ V}$, $V_{EE} = 0\text{ V}$, $V_{CM} = V_O = V_{CC}/2$, R_L to $V_{CC}/2$, $T_A = 25^\circ\text{C}$, unless otherwise noted.)

Characteristic	Symbol	Min	Typ	Max	Unit
Output Voltage Swing, Low ($V_{ID} = \pm 0.2\text{ V}$) $V_{CC} = 1.0\text{ V}$ ($T_A = 25^\circ\text{C}$) $R_L = 10\text{ k}\Omega$ $R_L = 600\ \Omega$ $V_{CC} = 1.0\text{ V}$ ($T_A = -40^\circ$ to 105°C) $R_L = 10\text{ k}\Omega$ $R_L = 600\ \Omega$ $V_{CC} = 3.0\text{ V}$ ($T_A = 25^\circ\text{C}$) $R_L = 10\text{ k}\Omega$ $R_L = 600\ \Omega$ $V_{CC} = 3.0\text{ V}$ ($T_A = -40^\circ$ to 105°C) $R_L = 10\text{ k}\Omega$ $R_L = 600\ \Omega$ $V_{CC} = 5.0\text{ V}$ ($T_A = 25^\circ\text{C}$) $R_L = 10\text{ k}\Omega$ $R_L = 600\ \Omega$ $V_{CC} = 5.0\text{ V}$ ($T_A = -40^\circ$ to 105°C) $R_L = 10\text{ k}\Omega$ $R_L = 600\ \Omega$	V_{OL}	0.05 0.1 0.1 0.15 0.05 0.1 0.1 0.15 0.05 0.1 0.1 0.15 0.1 0.2	0.02 0.05 – – 0.02 0.08 – – 0.02 0.1 – –	– – – – – – – – – – – – – –	V
Common Mode Rejection ($V_{in} = 0$ to 5.0 V)	CMR	60	75	–	dB
Power Supply Rejection $V_{CC}/V_{EE} = 5.0\text{ V/Ground}$ to 3.0 V/Ground	PSR	60	75	–	dB
Output Short Circuit Current (V_{in} Diff = $\pm 1.0\text{ V}$) $V_{CC} = 1.0\text{ V}$ Source Sink $V_{CC} = 3.0\text{ V}$ Source Sink $V_{CC} = 5.0\text{ V}$ Source Sink	I_{SC}	6.0 10 15 40 20 40	13 13 32 64 40 70	26 26 60 140 140 140	mA
Power Supply Current (Per Amplifier, $V_O = 0\text{ V}$) $V_{CC} = 1.0\text{ V}$ $V_{CC} = 3.0\text{ V}$ $V_{CC} = 5.0\text{ V}$ $V_{CC} = 1.0\text{ V}$ ($T_A = -40$ to 105°C) $V_{CC} = 3.0\text{ V}$ ($T_A = -40$ to 105°C) $V_{CC} = 5.0\text{ V}$ ($T_A = -40$ to 105°C)	I_D	– – – – – –	1.2 1.5 1.65 – – –	1.75 2.0 2.25 2.0 2.25 2.5	mA

MC33501, MC33503

AC ELECTRICAL CHARACTERISTICS ($V_{CC} = 5.0\text{ V}$, $V_{EE} = 0\text{ V}$, $V_{CM} = V_O = V_{CC}/2$, $T_A = 25^\circ\text{C}$, unless otherwise noted.)

Characteristic	Symbol	Min	Typ	Max	Unit
Slew Rate ($V_S = \pm 2.5\text{ V}$, $V_O = -2.0\text{ to }2.0\text{ V}$, $R_L = 2.0\text{ k}\Omega$, $A_V = 1.0$) Positive Slope Negative Slope	SR	1.8 1.8	3.0 3.0	6.0 6.0	V/ μs
Gain Bandwidth Product ($f = 100\text{ kHz}$) $V_{CC} = 0.5\text{ V}$, $V_{EE} = -0.5\text{ V}$ $V_{CC} = 1.5\text{ V}$, $V_{EE} = -1.5\text{ V}$ $V_{CC} = 2.5\text{ V}$, $V_{EE} = -2.5\text{ V}$	GBW	2.0 2.5 3.0	3.0 3.5 4.0	6.0 7.0 8.0	MHz
Gain Margin ($R_L = 10\text{ k}\Omega$, $C_L = 0\text{ pF}$)	Am	–	6.5	–	dB
Phase Margin ($R_L = 10\text{ k}\Omega$, $C_L = 0\text{ pF}$)	ϕ_m	–	60	–	Deg
Channel Separation ($f = 1.0\text{ Hz to }20\text{ kHz}$, $R_L = 600\ \Omega$)	CS	–	120	–	dB
Power Bandwidth ($V_O = 4.0\text{ V}_{pp}$, $R_L = 1.0\text{ k}\Omega$, $\text{THD} \leq 1.0\%$)	BW _P	–	200	–	kHz
Total Harmonic Distortion ($V_O = 4.5\text{ V}_{pp}$, $R_L = 600\ \Omega$, $A_V = 1.0$) $f = 1.0\text{ kHz}$ $f = 10\text{ kHz}$	THD	– –	0.004 0.01	– –	%
Differential Input Resistance ($V_{CM} = 0\text{ V}$)	R_{in}	–	>1.0	–	terra Ω
Differential Input Capacitance ($V_{CM} = 0\text{ V}$)	C_{in}	–	2.0	–	pF
Equivalent Input Noise Voltage ($V_{CC} = 1.0\text{ V}$, $V_{CM} = 0\text{ V}$, $V_{EE} = \text{Gnd}$, $R_S = 100\ \Omega$) $f = 1.0\text{ kHz}$	e_n	–	30	–	nV/ $\sqrt{\text{Hz}}$

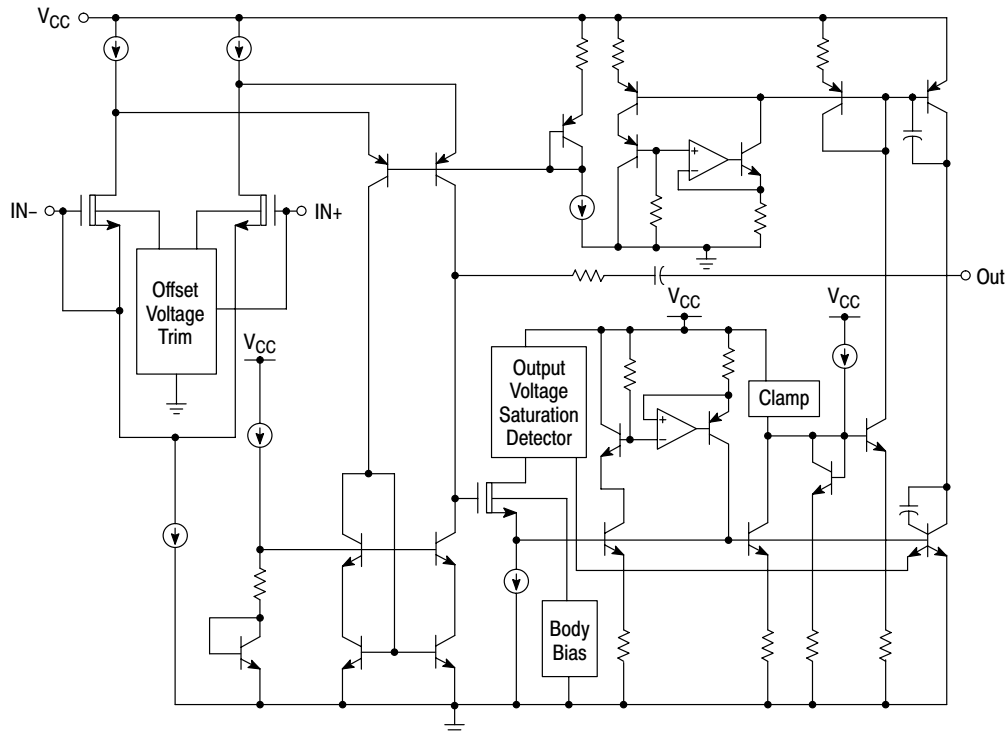

Figure 2. Representative Block Diagram

General Information

The MC33501/503 dual operational amplifier is unique in its ability to provide 1.0 V rail-to-rail performance on both the input and output by using a SMARTMOS™ process. The amplifier output swings within 50 mV of both rails and is able to provide 50 mA of output drive current with a 5.0 V supply, and 10 mA with a 1.0 V supply. A 5.0 MHz bandwidth and a slew rate of 3.0 V/μs is achieved with high speed depletion mode NMOS (DNMOS) and vertical PNP transistors. This device is characterized over a temperature range of -40°C to 105°C.

Circuit Information

Input Stage

One volt rail-to-rail performance is achieved in the MC33501/503 at the input by using a single pair of depletion mode NMOS devices (DNMOS) to form a differential amplifier with a very low input current of 40 fA. The normal input common mode range of a DNMOS device, with an ion implanted negative threshold, includes ground and relies on the body effect to dynamically shift the threshold to a positive value as the gates are moved from ground towards the positive supply. Because the device is manufactured in a p-well process, the body effect coefficient is sufficiently large to ensure that the input stage will remain substantially saturated when the inputs are at the positive rail. This also applies at very low supply voltages. The 1.0 V rail-to-rail input stage consists of a DNMOS differential amplifier, a folded cascode, and a low voltage balanced mirror. The low voltage cascoded balanced mirror provides high 1st stage gain and base current cancellation without sacrificing signal integrity. Also, the input offset voltage is trimmed to less than 1.0 mV because of the limited available supply voltage. The body voltage of the input DNMOS differential pair is internally trimmed to minimize the input offset voltage. A common mode feedback path is also employed to enable the offset voltage to track over the input common mode voltage. The total operational amplifier quiescent current drop is 1.3 mA/amp.

Output Stage

An additional feature of this device is an “on demand” base current cancellation amplifier. This feature provides base drive to the output power devices by making use of a buffer amplifier to perform a voltage-to-current conversion. This is done in direct proportion to the load conditions. This “on demand” feature allows these amplifiers to consume only a few micro-amps of current when the output stage is in its quiescent mode. Yet it provides high output current when required by the load. The rail-to-rail output stage current boost circuit provides 50 mA of output current with a 5.0 V supply (For a 1.0 V supply output stage will do 10 mA) enabling the operational amplifier to drive a 600 Ω load. A buffer is necessary to isolate the load current effects in the output stage from the input stage. Because of the low voltage conditions, a DNMOS follower is used to provide an essentially zero voltage level shift. This buffer isolates any load current changes on the output stage from loading the input stage. A high speed vertical PNP transistor provides excellent frequency performance while sourcing current. The operational amplifier is also internally compensated to provide a phase margin of 60 degrees. It has a unity gain of 5.0 MHz with a 5.0 V supply and 4.0 MHz with a 1.0 V supply.

Low Voltage Operation

The MC33501/503 will operate at supply voltages from 0.9 to 7.0 V and ground. When using the MC33501/503 at supply voltages of less than 1.2 V, input offset voltage may increase slightly as the input signal swings within approximately 50 mV of the positive supply rail. This effect occurs only for supply voltages below 1.2 V, due to the input depletion mode MOSFETs starting to transition between the saturated to linear region, and should be considered when designing high side dc sensing applications operating at the positive supply rail. Since the device is rail-to-rail on both input and output, high dynamic range single battery cell applications are now possible.

MC33501, MC33503

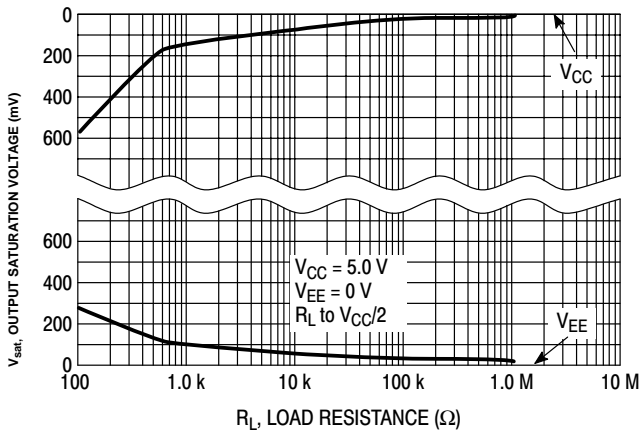

Figure 3. Output Saturation versus Load Resistance

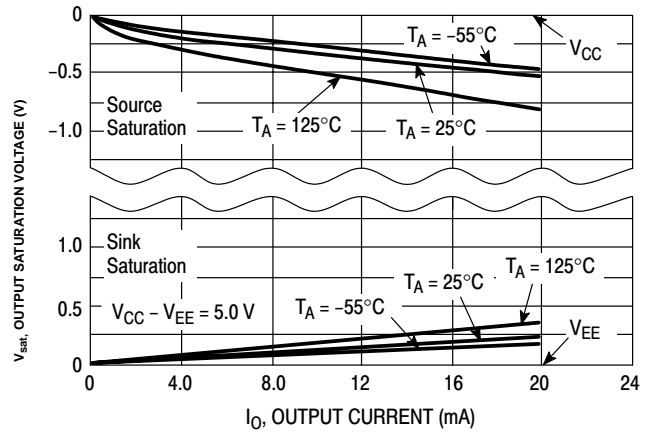

Figure 4. Drive Output Source/Sink Saturation Voltage versus Load Current

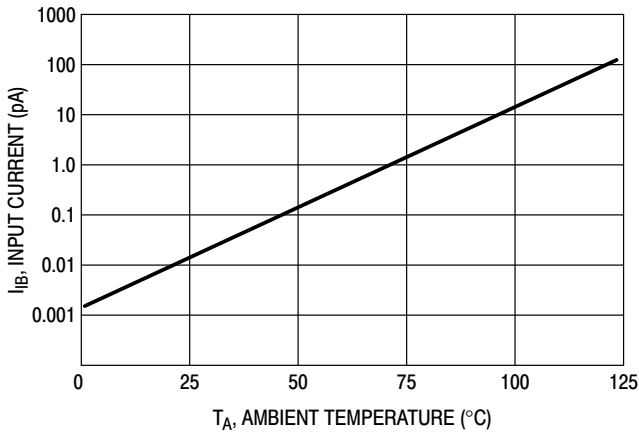

Figure 5. Input Current versus Temperature

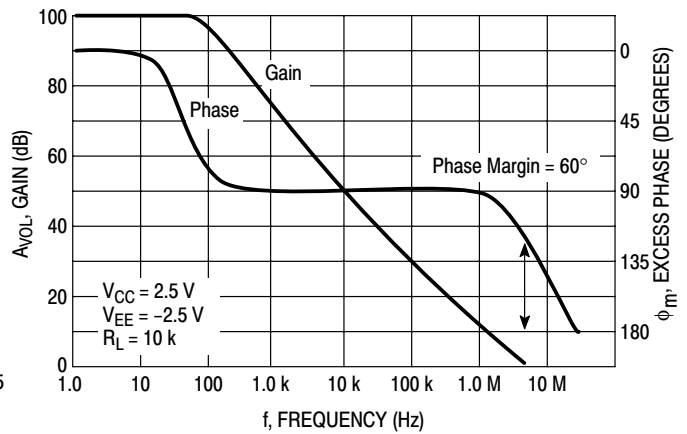

Figure 6. Gain and Phase versus Frequency

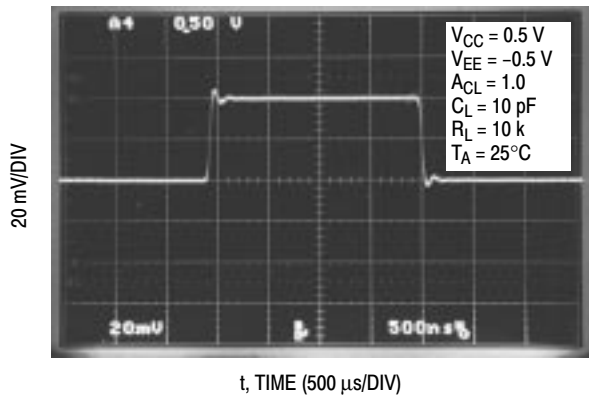

Figure 7. Transient Response

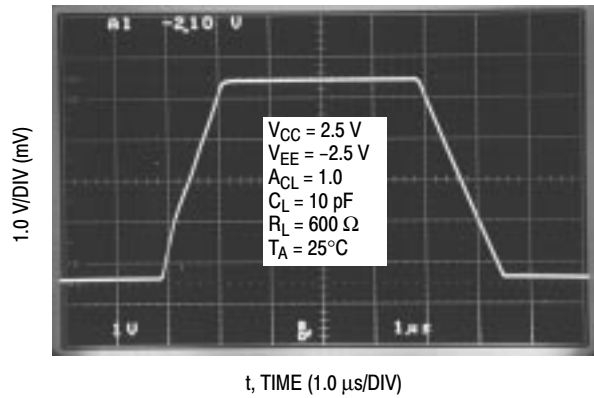

Figure 8. Slew Rate

MC33501, MC33503

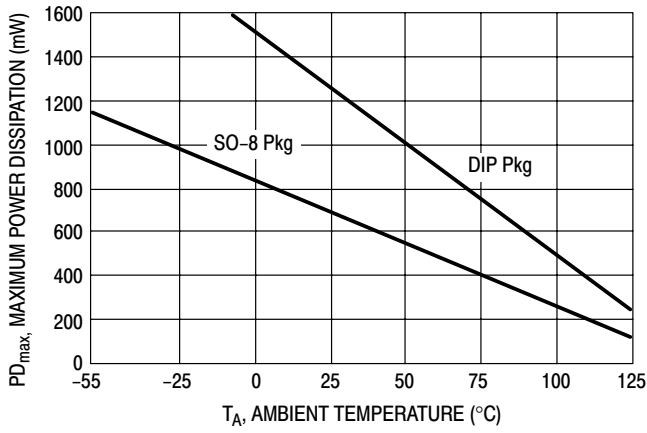

Figure 9. Maximum Power Dissipation versus Temperature

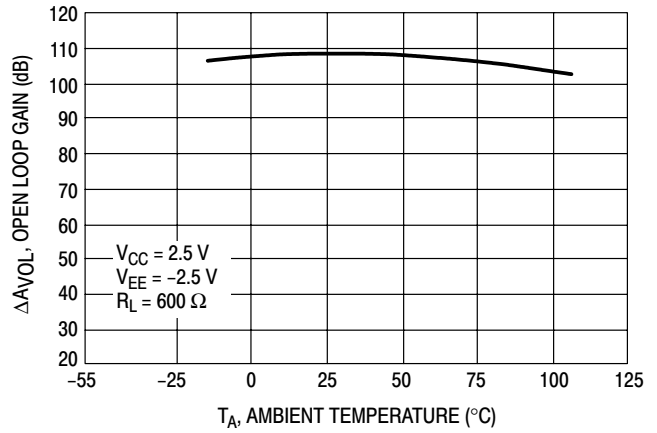

Figure 10. Open Loop Voltage Gain versus Temperature

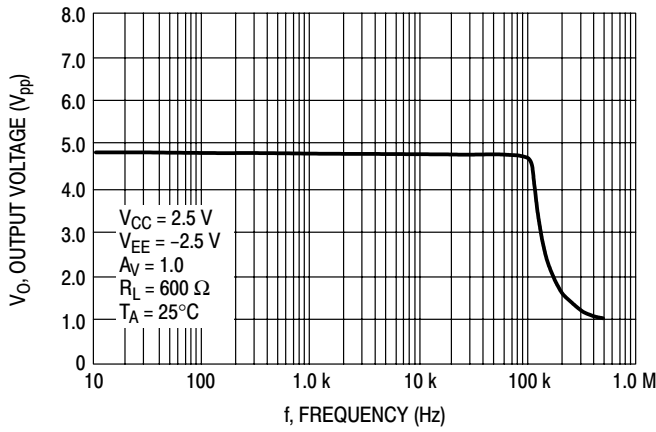

Figure 11. Output Voltage versus Frequency

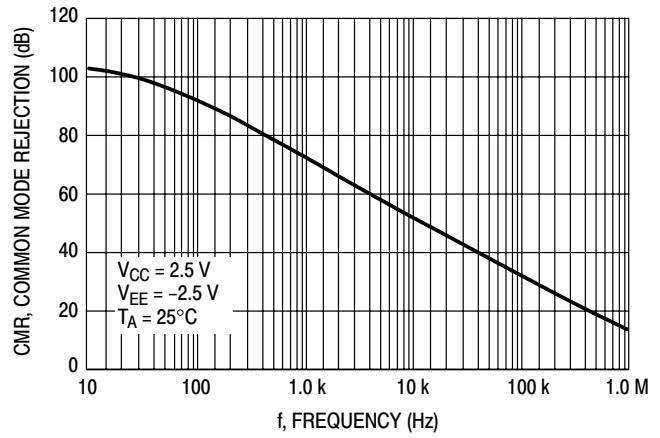

Figure 12. Common Mode Rejection versus Frequency

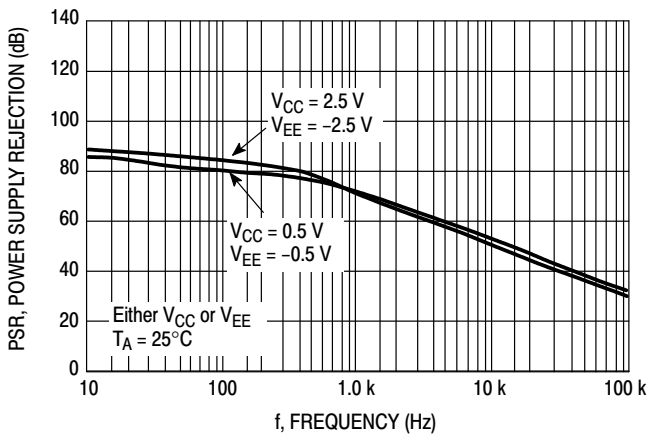

Figure 13. Power Supply Rejection versus Frequency

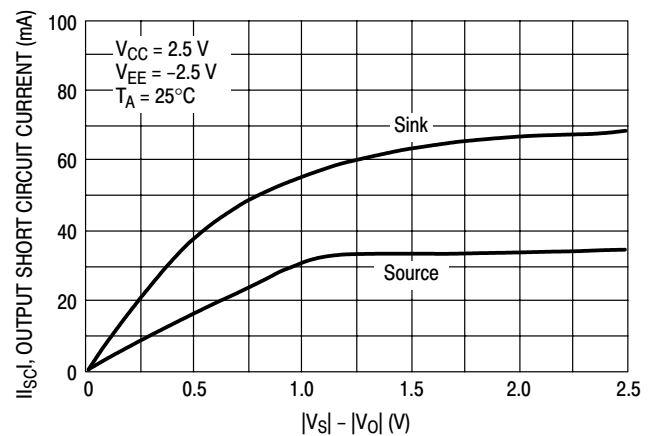

Figure 14. Output Short Circuit Current versus Output Voltage

MC33501, MC33503

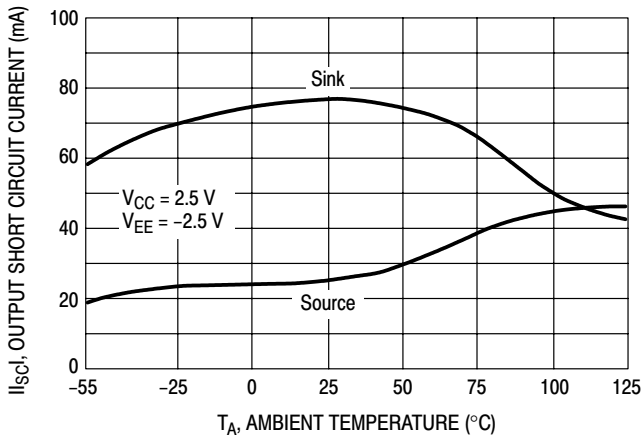

Figure 15. Output Short Circuit Current versus Temperature

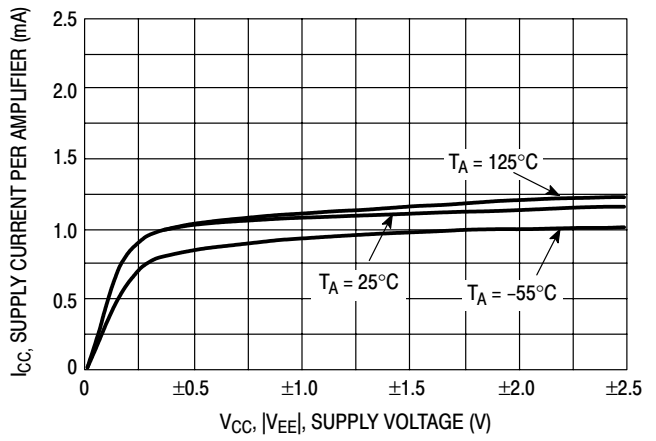

Figure 16. Supply Current per Amplifier versus Supply Voltage with No Load

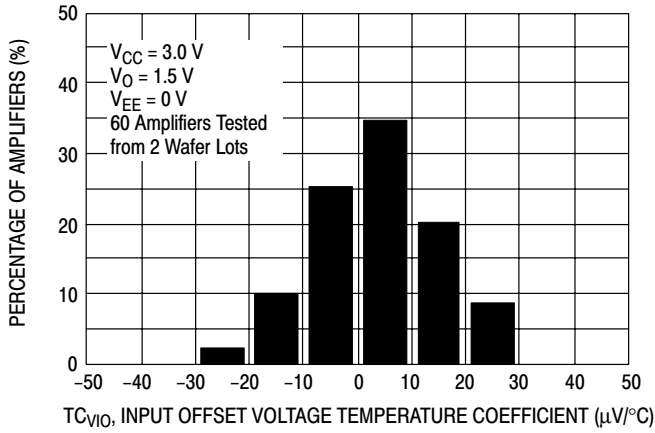

Figure 17. Input Offset Voltage Temperature Coefficient Distribution

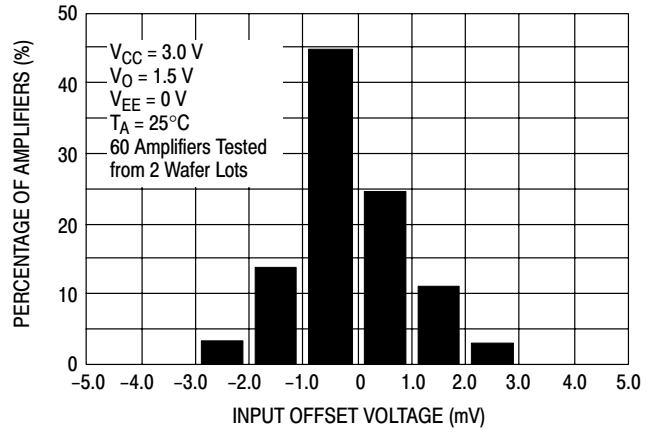

Figure 18. Input Offset Voltage Distribution

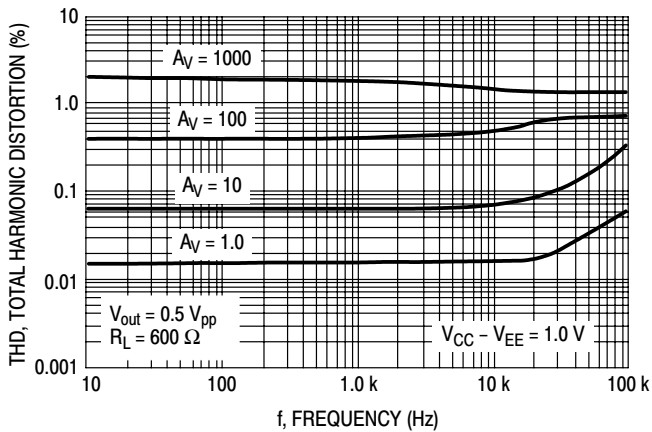

Figure 19. Total Harmonic Distortion versus Frequency with 1.0 V Supply

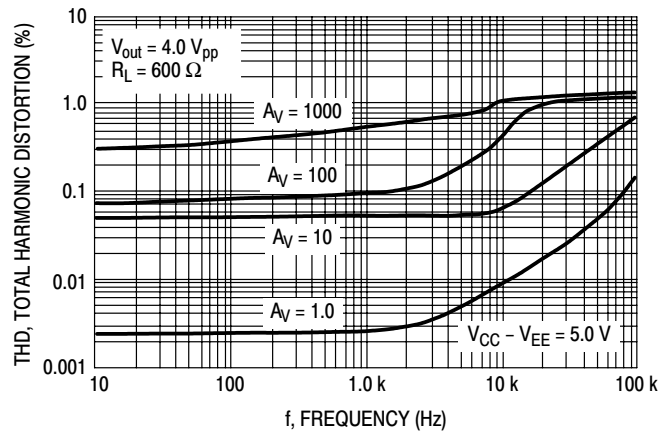

Figure 20. Total Harmonic Distortion versus Frequency with 5.0 V Supply

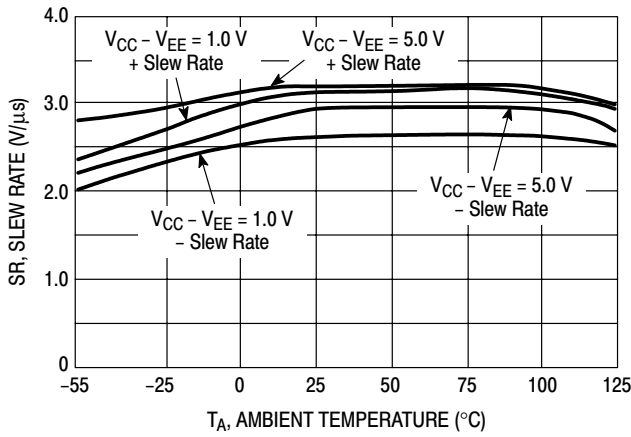

Figure 21. Slew Rate versus Temperature

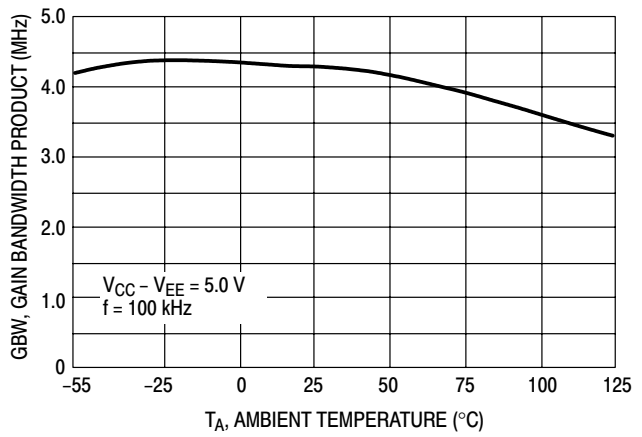

Figure 22. Gain Bandwidth Product versus Temperature

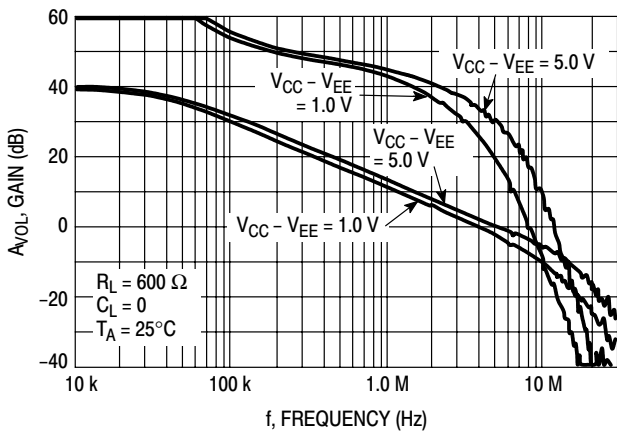

Figure 23. Voltage Gain and Phase versus Frequency

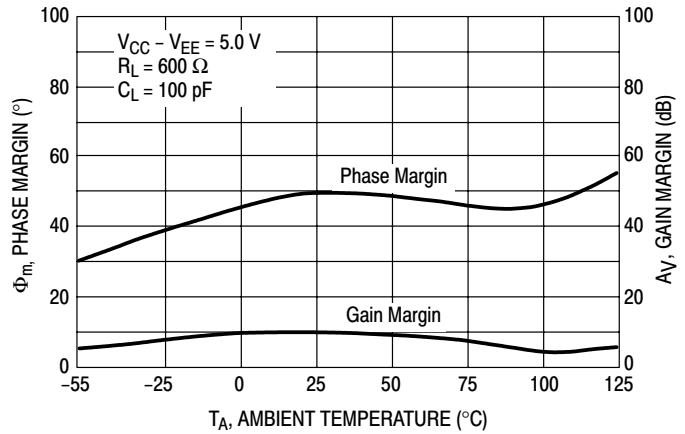

Figure 24. Gain and Phase Margin versus Temperature

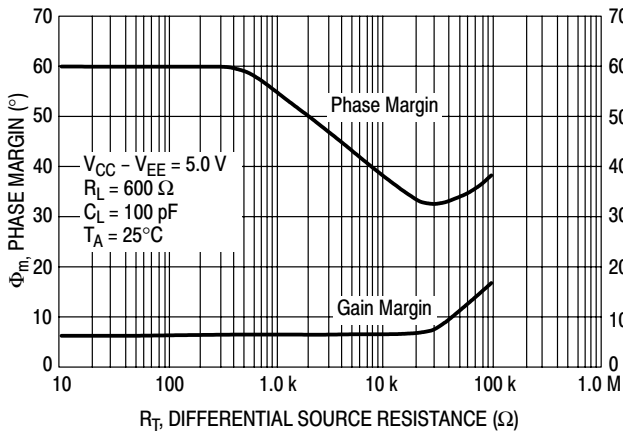

Figure 25. Gain and Phase Margin versus Differential Source Resistance

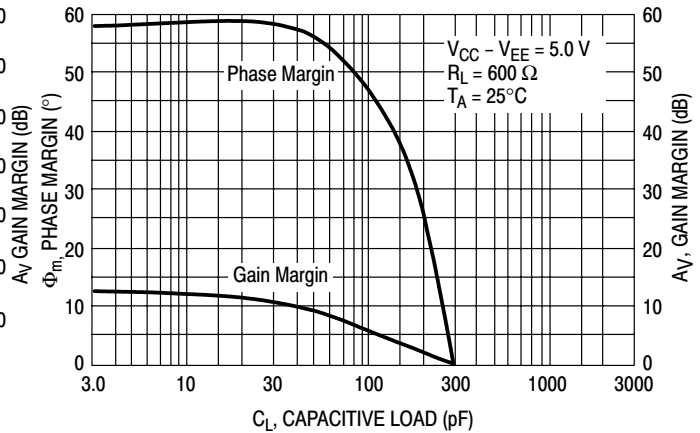

Figure 26. Feedback Loop Gain and Phase versus Capacitive Load

MC33501, MC33503

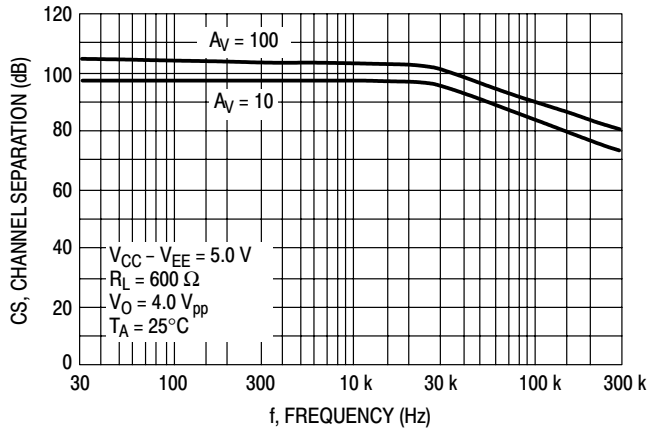

Figure 27. Channel Separation versus Frequency

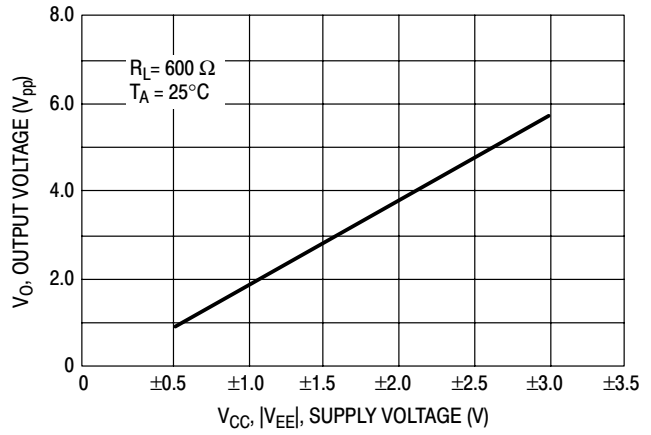

Figure 28. Output Voltage Swing versus Supply Voltage

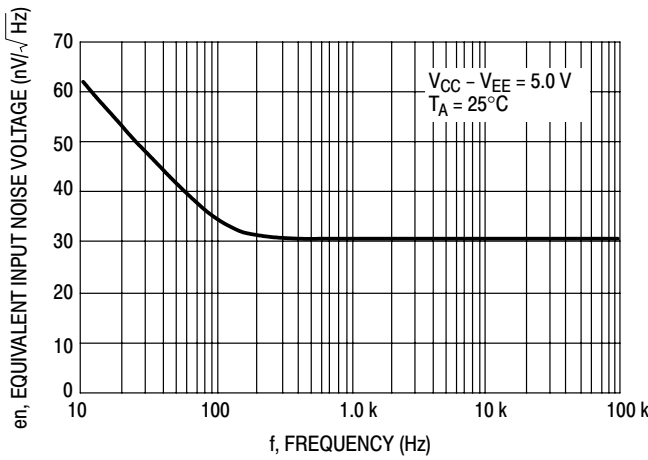

Figure 29. Equivalent Input Noise Voltage versus Frequency

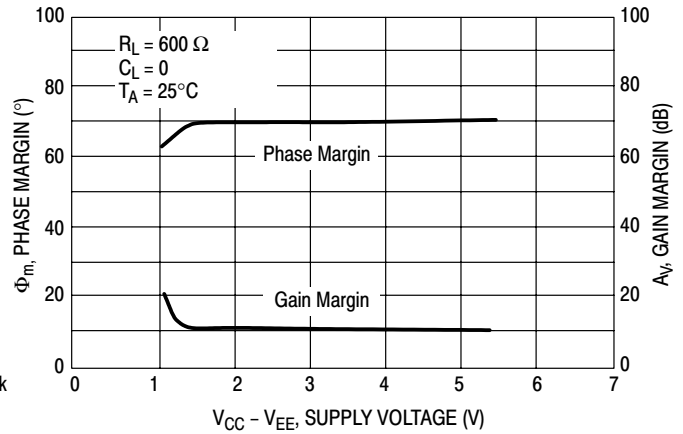

Figure 30. Gain and Phase Margin versus Supply Voltage

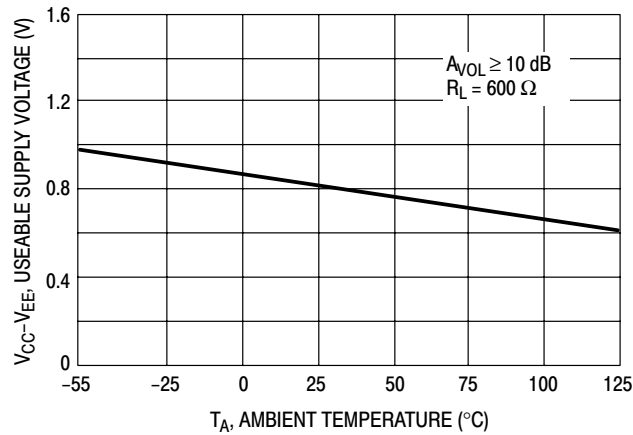

Figure 31. Useable Supply Voltage versus Temperature

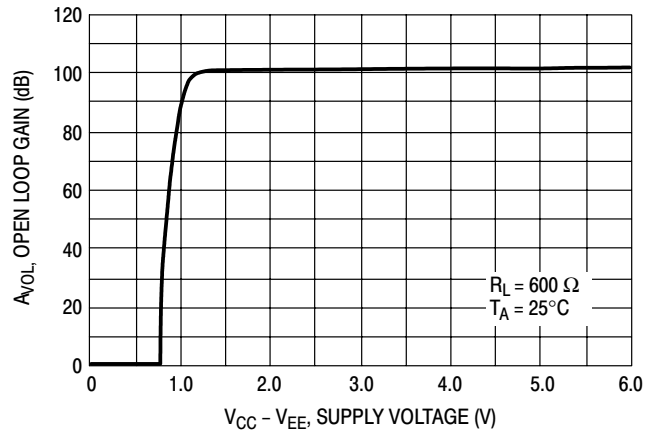

Figure 32. Open Loop Gain versus Supply Voltage

MC33501, MC33503

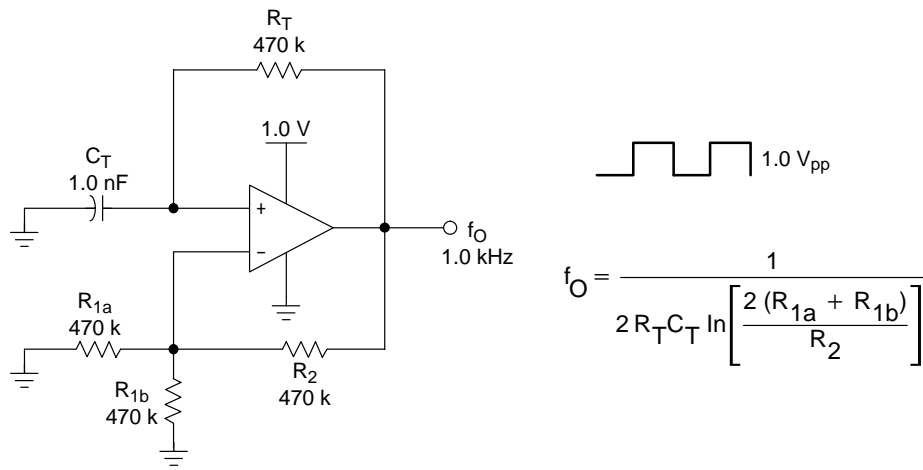

Figure 33. 1.0 V Oscillator

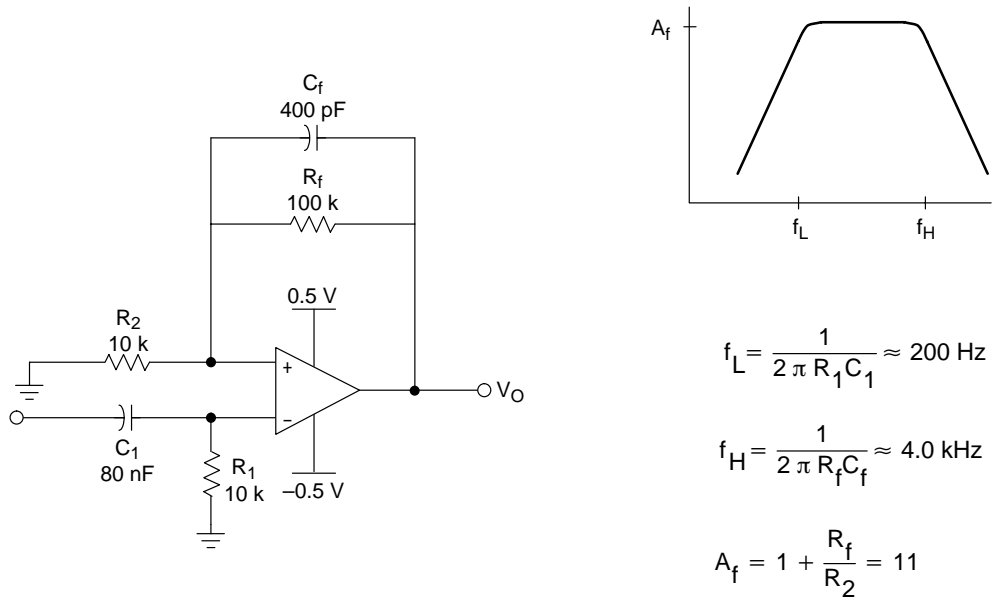

Figure 34. 1.0 V Voiceband Filter

MC33501, MC33503

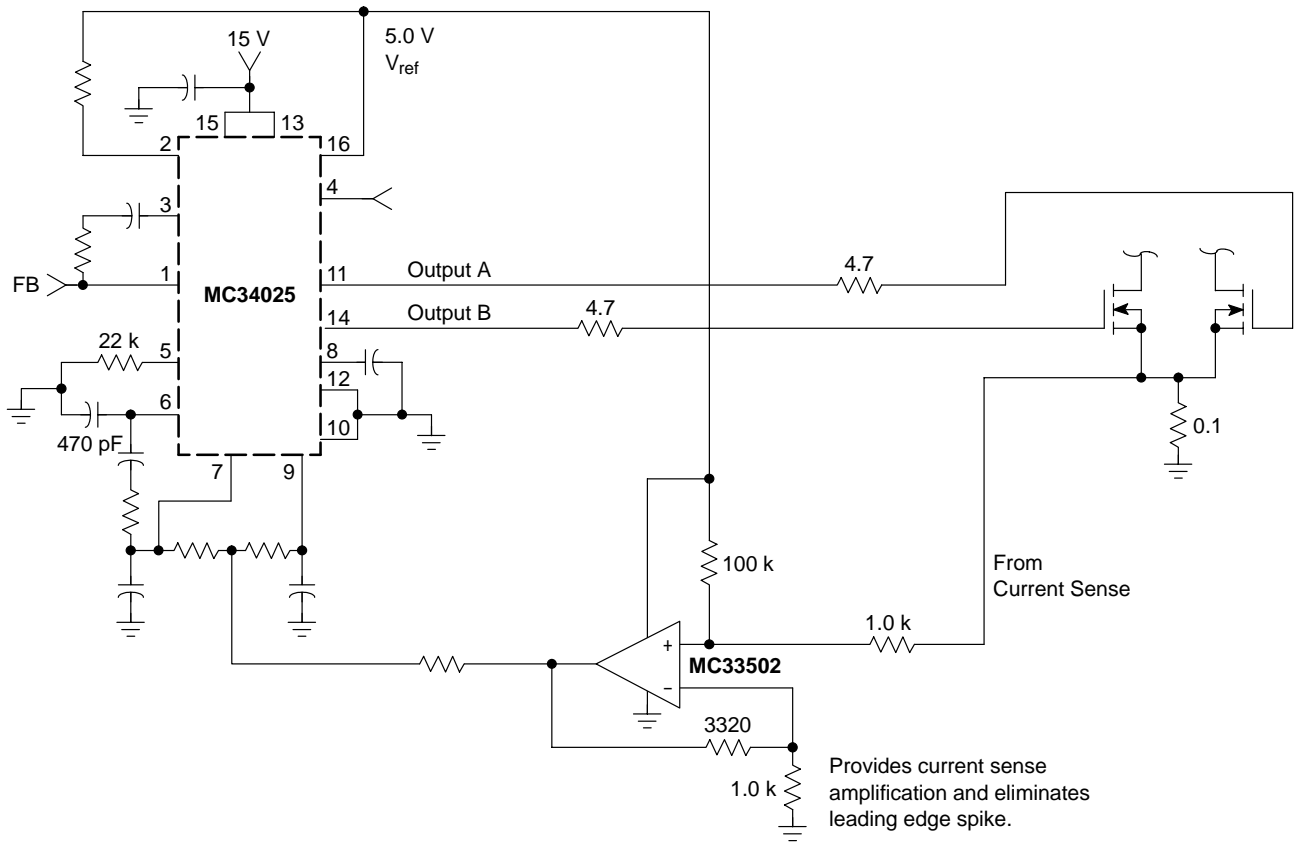
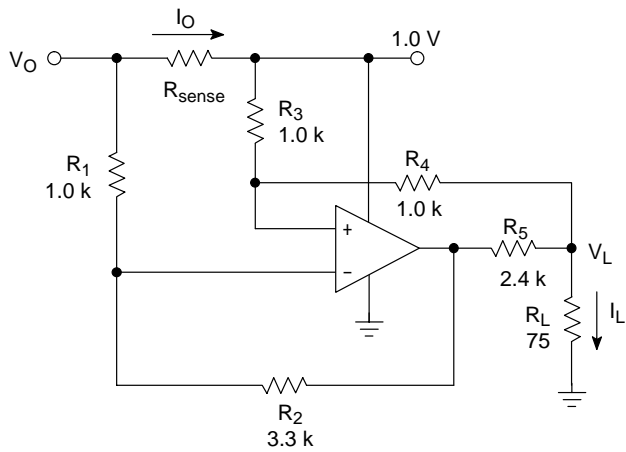

Figure 35. Power Supply Application



I_O	I_L	$\Delta I_O / \Delta I_L$
435 mA	463 μ A	-120×10^{-6}
212 mA	492 μ A	

For best performance, use low tolerance resistors.

Figure 36. 1.0 V Current Pump

MC33501, MC33503

PACKAGE DIMENSIONS

SOT23-5
(TSOP-5, SC59-5)
SN SUFFIX
CASE 483-01
ISSUE B

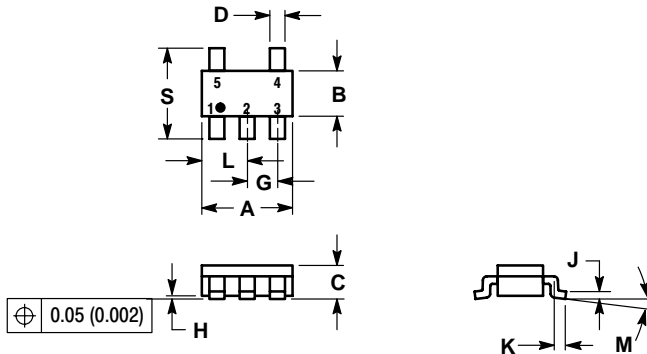

NOTES:

1. DIMENSIONING AND TOLERANCING PER ANSI Y14.5M, 1982.
2. CONTROLLING DIMENSION: MILLIMETER.
3. MAXIMUM LEAD THICKNESS INCLUDES LEAD FINISH THICKNESS. MINIMUM LEAD THICKNESS IS THE MINIMUM THICKNESS OF BASE MATERIAL.

DIM	MILLIMETERS		INCHES	
	MIN	MAX	MIN	MAX
A	2.90	3.10	0.1142	0.1220
B	1.30	1.70	0.0512	0.0669
C	0.90	1.10	0.0354	0.0433
D	0.25	0.50	0.0098	0.0197
G	0.85	1.05	0.0335	0.0413
H	0.013	0.100	0.0005	0.0040
J	0.10	0.26	0.0040	0.0102
K	0.20	0.60	0.0079	0.0236
L	1.25	1.55	0.0493	0.0610
M	0°	10°	0°	10°
S	2.50	3.00	0.0985	0.1181

Notes

SMARTMOS is a trademark of Motorola, Inc.

ON Semiconductor and  are trademarks of Semiconductor Components Industries, LLC (SCILLC). SCILLC reserves the right to make changes without further notice to any products herein. SCILLC makes no warranty, representation or guarantee regarding the suitability of its products for any particular purpose, nor does SCILLC assume any liability arising out of the application or use of any product or circuit, and specifically disclaims any and all liability, including without limitation special, consequential or incidental damages. "Typical" parameters which may be provided in SCILLC data sheets and/or specifications can and do vary in different applications and actual performance may vary over time. All operating parameters, including "Typicals" must be validated for each customer application by customer's technical experts. SCILLC does not convey any license under its patent rights nor the rights of others. SCILLC products are not designed, intended, or authorized for use as components in systems intended for surgical implant into the body, or other applications intended to support or sustain life, or for any other application in which the failure of the SCILLC product could create a situation where personal injury or death may occur. Should Buyer purchase or use SCILLC products for any such unintended or unauthorized application, Buyer shall indemnify and hold SCILLC and its officers, employees, subsidiaries, affiliates, and distributors harmless against all claims, costs, damages, and expenses, and reasonable attorney fees arising out of, directly or indirectly, any claim of personal injury or death associated with such unintended or unauthorized use, even if such claim alleges that SCILLC was negligent regarding the design or manufacture of the part. SCILLC is an Equal Opportunity/Affirmative Action Employer.

PUBLICATION ORDERING INFORMATION

Literature Fulfillment:

Literature Distribution Center for ON Semiconductor
P.O. Box 5163, Denver, Colorado 80217 USA
Phone: 303-675-2175 or 800-344-3860 Toll Free USA/Canada
Fax: 303-675-2176 or 800-344-3867 Toll Free USA/Canada
Email: ONlit@hibbertco.com

N. American Technical Support: 800-282-9855 Toll Free USA/Canada

JAPAN: ON Semiconductor, Japan Customer Focus Center
4-32-1 Nishi-Gotanda, Shinagawa-ku, Tokyo, Japan 141-0031
Phone: 81-3-5740-2700
Email: r14525@onsemi.com

ON Semiconductor Website: <http://onsemi.com>

For additional information, please contact your local Sales Representative.