

STT49GKxxB

Thyristor-Thyristor Modules

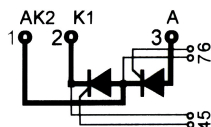

Type	V_{RSM} V_{DSM} V	V_{RRM} V_{DRM} V
STT49GK08B	900	800
STT49GK12B	1300	1200
STT49GK14B	1500	1400
STT49GK16B	1700	1600
STT49GK18B	1900	1800

Tolerance: ±0.5mm

Dimensions in mm (1mm=0.0394")

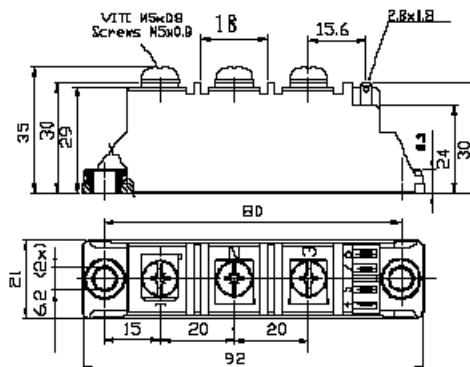

Symbol	Test Conditions	Maximum Ratings	Unit
I_{TRMS}, I_{FRMS} I_{TAVM}, I_{FAVM}	$T_{VJ}=T_{VJM}$ $T_C=85^{\circ}C$; 180° sine	76 49	A
I_{TSM}, I_{FSM}	$T_{VJ}=45^{\circ}C$ $V_R=0$ t=10ms (50Hz), sine t=8.3ms (60Hz), sine	1150 1230	A
	$T_{VJ}=T_{VJM}$ $V_R=0$ t=10ms(50Hz), sine t=8.3ms(60Hz), sine	1000 1070	
$\int i^2 dt$	$T_{VJ}=45^{\circ}C$ $V_R=0$ t=10ms (50Hz), sine t=8.3ms (60Hz), sine	6600 6280	A ² s
	$T_{VJ}=T_{VJM}$ $V_R=0$ t=10ms(50Hz), sine t=8.3ms(60Hz), sine	5000 4750	
$(di/dt)_{cr}$	$T_{VJ}=T_{VJM}$ f=50Hz, $t_p=200\mu s$ $V_D=2/3V_{DRM}$ $I_G=0.45A$ $di_G/dt=0.45A/\mu s$ repetitive, $I_T=150A$	150	A/ μs
	non repetitive, $I_T=I_{TAVM}$	500	
$(dv/dt)_{cr}$	$T_{VJ}=T_{VJM}$; $R_{GK}=\infty$; method 1 (linear voltage rise) $V_{DR}=2/3V_{DRM}$	1000	V/ μs
P_{GM}	$T_{VJ}=T_{VJM}$ $I_T=I_{TAVM}$ $t_p=30\mu s$ $t_p=300\mu s$	10 5	W
		0.5	
P_{GAV}		10	W
V_{RGM}		10	V
T_{VJ} T_{VJM} T_{stg}		-40...+125 125 -40...+125	°C
V_{ISOL}	50/60Hz, RMS $I_{ISOL}\leq 1mA$ t=1min t=1s	3000 3600	V~
M_d	Mounting torque (M5) Terminal connection torque (M5)	2.5-4.0/22-35 2.5-4.0/22-35	Nm/lb.in.
Weight	Typ.	110	g

STT49GKxxB

Thyristor-Thyristor Modules

Symbol	Test Conditions	Characteristic Values	Unit
I_{RRM}, I_{DRM}	$T_{VJ}=T_{VJM}; V_R=V_{RRM}; V_D=V_{DRM}$	5	mA
V_{TM}	$I_{TM}=147A; T_{VJ}=25^{\circ}C$	1.65	V
V_{TO}	For power-loss calculations only ($T_{VJ}=125^{\circ}C$)	0.85	V
r_T		5.3	$m\Omega$
V_{GT}	$V_D=6V; T_{VJ}=25^{\circ}C$ $T_{VJ}=-40^{\circ}C$	1.5 max 1.6 max	V
I_{GT}	$V_D=6V; T_{VJ}=25^{\circ}C$ $T_{VJ}=-40^{\circ}C$	100 200	mA
V_{GD}	$T_{VJ}=T_{VJM}; V_D=2/3V_{DRM}$	0.2	V
I_{GD}		10	mA
I_L	$T_{VJ}=25^{\circ}C; t_p=10\mu s; V_D=6V$ $I_G=0.45A; di_G/dt=0.45A/\mu s$	450	mA
I_H	$T_{VJ}=25^{\circ}C; V_D=6V; R_{GK}=\infty$	200	mA
t_{gd}	$T_{VJ}=25^{\circ}C; V_D=1/2V_{DRM}$ $I_G=0.45A; di_G/dt=0.45A/\mu s$	2	μs
t_q	$T_{VJ}=T_{VJM}; I_T=120A; t_p=200\mu s; -di/dt=10A/\mu s$ $V_R=100V; dv/dt=20V/\mu s; V_D=2/3V_{DRM}$ typ.	150	μs
Q_s	$T_{VJ}=T_{VJM}; I_T, I_F=50A; -di/dt=0.64A/\mu s$	90	μC
I_{RM}		11	A
R_{thJC}	per thyristor/diode; DC current per module	0.53 0.265	K/W
R_{thJK}	per thyristor/diode; DC current per module	0.73 0.365	K/W
d_s	Creeping distance on surface	12.7	mm
d_a	Strike distance through air	9.6	mm
a	Maximum allowable acceleration	50	m/s^2

FEATURES

- * International standard package
- * Copper base plate
- * Glass passivated chips
- * Isolation voltage 3600 V~
- * UL file NO.310749
- * RoHs compliant

APPLICATIONS

- * DC motor control
- * Softstart AC motor controller
- * Light, heat and temperature control

ADVANTAGES

- * Space and weight savings
- * Simple mounting with two screws
- * Improved temperature and power cycling
- * Reduced protection circuits

STT49GKxxB

Thyristor-Thyristor Modules

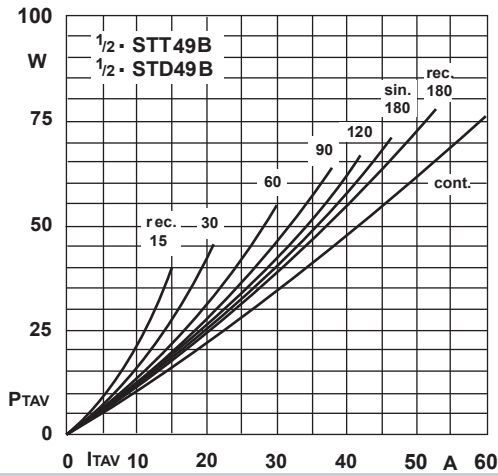

Fig.1L Power dissipation per thyristor vs. on-state current

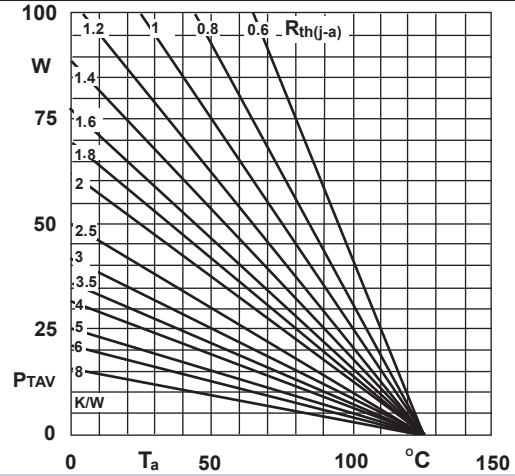

Fig.1R Power dissipation per thyristor vs. ambient temp

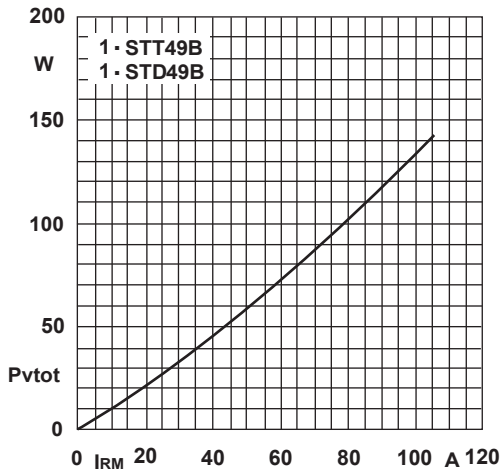

Fig.2L Power dissipation per module vs. rms current

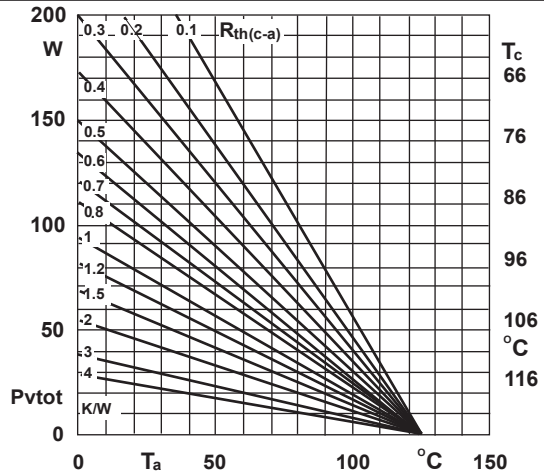

Fig.2R Power dissipation per module vs. case temp

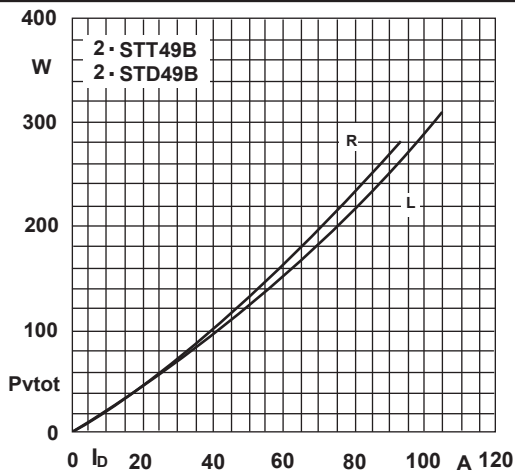

Fig.3L Power dissipation of two modules vs. direct current

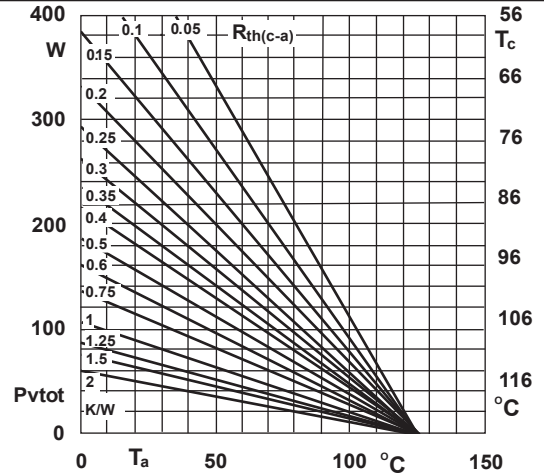

Fig.3R Power dissipation of two modules vs. case temp

STT49GKxxB

Thyristor-Thyristor Modules

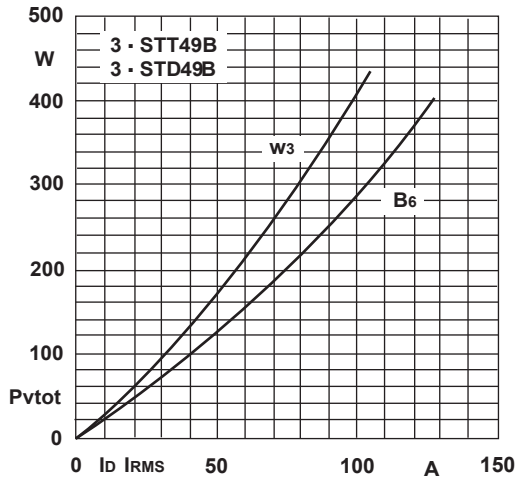

Fig.4L Power dissipation of three modules vs. direct and rms current

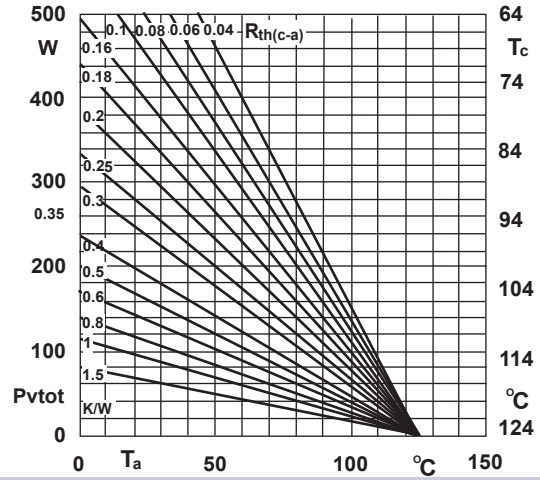

Fig.4R Power dissipation of three modules vs. case temp

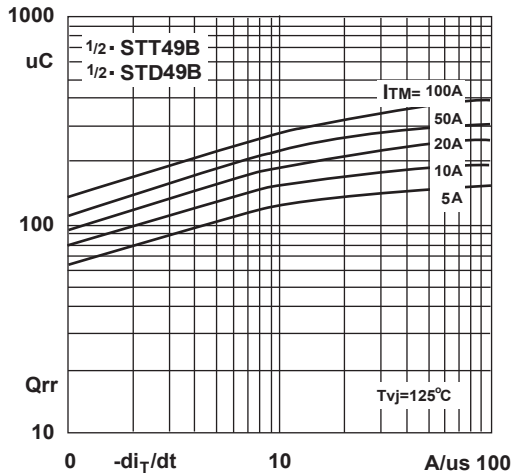

Fig.5 Recovered charge vs. current decrease

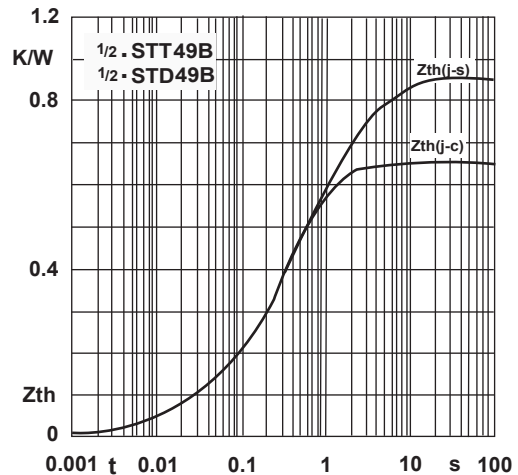

Fig.6 Transient thermal impedance vs. time

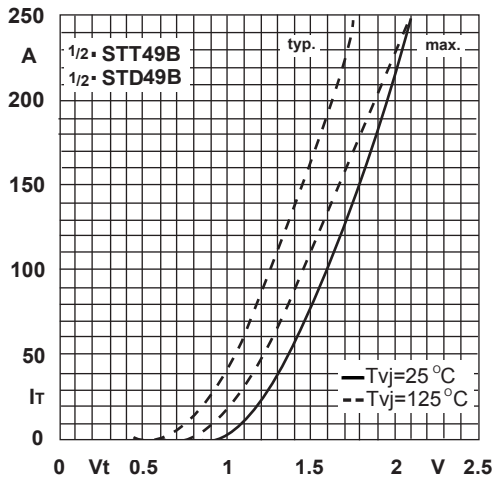

Fig.7 On-state characteristics

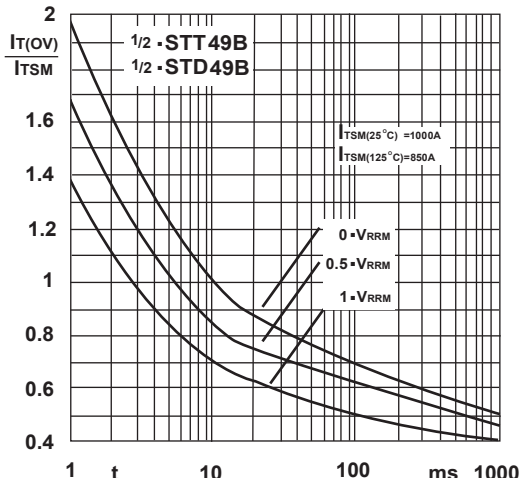

Fig.8 Surge overload current vs. time