

Cool MOS™ Power Transistor

Feature

- New revolutionary high voltage technology
- Ultra low gate charge
- Periodic avalanche rated
- Extreme dv/dt rated
- Ultra low effective capacitances
- Improved transconductance
- Pb-free lead plating; RoHS compliant
- Qualified according to JEDEC⁰⁾ for target applications

| | | |
|--------------|-----|----------|
| V_{DS} | 600 | V |
| $R_{DS(on)}$ | 1.4 | Ω |
| I_D | 3.2 | A |

PG-TO252

PG-TO251

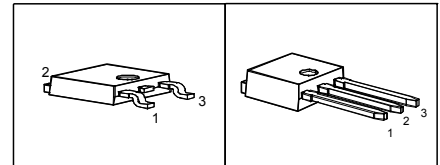

| Type | Package | Ordering Code | Marking |
|------------|----------|---------------|---------|
| SPU03N60S5 | PG-TO251 | Q67040-S4227 | 03N60S5 |
| SPD03N60S5 | PG-TO252 | Q67040-S4187 | 03N60S5 |

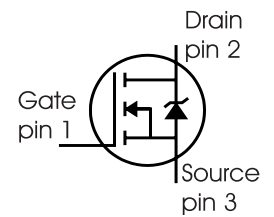

Maximum Ratings

| Parameter | Symbol | Value | Unit |
|---|---------------------|-------------|------------------|
| Continuous drain current $T_C = 25\text{ }^\circ\text{C}$ $T_C = 100\text{ }^\circ\text{C}$ | I_D | 3.2 2 | A |
| Pulsed drain current, t_p limited by T_{jmax} | $I_{D\text{ puls}}$ | 5.7 | |
| Avalanche energy, single pulse $I_D = 2.4\text{ A}$, $V_{DD} = 50\text{ V}$ | E_{AS} | 100 | mJ |
| Avalanche energy, repetitive t_{AR} limited by T_{jmax} ¹ $I_D = 3.2\text{ A}$, $V_{DD} = 50\text{ V}$ | E_{AR} | 0.2 | |
| Avalanche current, repetitive t_{AR} limited by T_{jmax} | I_{AR} | 3.2 | A |
| Gate source voltage | V_{GS} | ± 20 | V |
| Gate source voltage AC ($f > 1\text{ Hz}$) | V_{GS} | ± 30 | |
| Power dissipation, $T_C = 25\text{ }^\circ\text{C}$ | P_{tot} | 38 | W |
| Operating and storage temperature | T_j, T_{stg} | -55... +150 | $^\circ\text{C}$ |

Maximum Ratings

| Parameter | Symbol | Value | Unit |
|---|---------|-------|------|
| Drain Source voltage slope $V_{DS} = 480 \text{ V}$, $I_D = 3.2 \text{ A}$, $T_j = 125 \text{ }^\circ\text{C}$ | dv/dt | 20 | V/ns |

Thermal Characteristics

| Parameter | Symbol | Values | | | Unit |
|---|------------|--------|------|----------|------------------|
| | | min. | typ. | max. | |
| Thermal resistance, junction - case | R_{thJC} | - | - | 3.3 | K/W |
| Thermal resistance, junction - ambient, leaded | R_{thJA} | - | - | 75 | |
| SMD version, device on PCB: @ min. footprint @ 6 cm ² cooling area ²⁾ | R_{thJA} | - | - | 75 50 | |
| Soldering temperature, *) 1.6 mm (0.063 in.) from case for 10s | T_{sold} | - | - | 260 | $^\circ\text{C}$ |

Electrical Characteristics, at $T_j=25^\circ\text{C}$ unless otherwise specified

| Parameter | Symbol | Conditions | Values | | | Unit |
|---|---------------|--|--------|-------------|----------|---------------|
| | | | min. | typ. | max. | |
| Drain-source breakdown voltage | $V_{(BR)DSS}$ | $V_{GS}=0\text{V}$, $I_D=0.25\text{mA}$ | 600 | - | - | V |
| Drain-Source avalanche breakdown voltage | $V_{(BR)DS}$ | $V_{GS}=0\text{V}$, $I_D=3.2\text{A}$ | - | 700 | - | |
| Gate threshold voltage | $V_{GS(th)}$ | $I_D=135\mu\text{A}$, $V_{GS}=V_{DS}$ | 3.5 | 4.5 | 5.5 | |
| Zero gate voltage drain current | I_{DSS} | $V_{DS}=600\text{V}$, $V_{GS}=0\text{V}$, $T_j=25^\circ\text{C}$, $T_j=150^\circ\text{C}$ | - - | 0.5 - | 1 70 | μA |
| Gate-source leakage current | I_{GSS} | $V_{GS}=20\text{V}$, $V_{DS}=0\text{V}$ | - | - | 100 | nA |
| Drain-source on-state resistance | $R_{DS(on)}$ | $V_{GS}=10\text{V}$, $I_D=2\text{A}$, $T_j=25^\circ\text{C}$ $T_j=150^\circ\text{C}$ | - - | 1.26 3.4 | 1.4 - | Ω |

*) TO252: reflow soldering, MSL3; TO251: wavesoldering

Electrical Characteristics , at $T_j = 25\text{ }^\circ\text{C}$, unless otherwise specified

| Parameter | Symbol | Conditions | Values | | | Unit |
|------------------------------|--------------|--|--------|------|------|------|
| | | | min. | typ. | max. | |
| Characteristics | | | | | | |
| Transconductance | g_{fs} | $V_{DS} \geq 2 \cdot I_D \cdot R_{DS(on)max}$, $I_D = 2\text{A}$ | - | 1.8 | - | S |
| Input capacitance | C_{iss} | $V_{GS} = 0\text{V}$, $V_{DS} = 25\text{V}$, $f = 1\text{MHz}$ | - | 420 | - | pF |
| Output capacitance | C_{oss} | | - | 150 | - | |
| Reverse transfer capacitance | C_{rss} | | - | 3.6 | - | |
| Turn-on delay time | $t_{d(on)}$ | $V_{DD} = 350\text{V}$, $V_{GS} = 0/10\text{V}$, $I_D = 3.2\text{A}$, $R_G = 20\Omega$ | - | 35 | - | ns |
| Rise time | t_r | | - | 25 | - | |
| Turn-off delay time | $t_{d(off)}$ | | - | 40 | - | |
| Fall time | t_f | | - | 15 | 22.5 | |

Gate Charge Characteristics

| | | | | | | |
|-----------------------|-----------------|--|---|------|----|----|
| Gate to source charge | Q_{gs} | $V_{DD} = 350\text{V}$, $I_D = 3.2\text{A}$ | - | 3.5 | - | nC |
| Gate to drain charge | Q_{gd} | | - | 7 | - | |
| Gate charge total | Q_g | $V_{DD} = 350\text{V}$, $I_D = 3.2\text{A}$, $V_{GS} = 0$ to 10V | - | 12.4 | 16 | |
| Gate plateau voltage | $V_{(plateau)}$ | $V_{DD} = 350\text{V}$, $I_D = 3.2\text{A}$ | - | 8 | - | V |

⁰J-STD20 and JESD22

¹Repetitive avalanche causes additional power losses that can be calculated as $P_{AV} = E_{AR} \cdot f$.

²Device on 40mm*40mm*1.5mm epoxy PCB FR4 with 6cm² (one layer, 70 μm thick) copper area for drain connection. PCB is vertical without blown air.

Electrical Characteristics, at $T_j = 25^\circ\text{C}$, unless otherwise specified

| Parameter | Symbol | Conditions | Values | | | Unit |
|--|----------|-----------------------------------|--------|------|------|---------------|
| | | | min. | typ. | max. | |
| Inverse diode continuous forward current | I_S | $T_C=25^\circ\text{C}$ | - | - | 3.2 | A |
| Inverse diode direct current, pulsed | I_{SM} | | - | - | 5.7 | |
| Inverse diode forward voltage | V_{SD} | $V_{GS}=0\text{V}, I_F=I_S$ | - | 1 | 1.2 | V |
| Reverse recovery time | t_{rr} | $V_R=350\text{V}, I_F=I_S,$ | - | 1000 | 1700 | ns |
| Reverse recovery charge | Q_{rr} | $di_F/dt=100\text{A}/\mu\text{s}$ | - | 2.3 | - | μC |

Typical Transient Thermal Characteristics

| Symbol | Value | Unit | Symbol | Value | Unit |
|--------------------|-------|------|---------------------|------------|------|
| | typ. | | | typ. | |
| Thermal resistance | | | Thermal capacitance | | |
| R_{th1} | 0.054 | K/W | C_{th1} | 0.00005232 | Ws/K |
| R_{th2} | 0.103 | | C_{th2} | 0.0002034 | |
| R_{th3} | 0.178 | | C_{th3} | 0.0002963 | |
| R_{th4} | 0.757 | | C_{th4} | 0.0009103 | |
| R_{th5} | 0.682 | | C_{th5} | 0.002084 | |
| R_{th6} | 0.202 | | C_{th6} | 0.024 | |

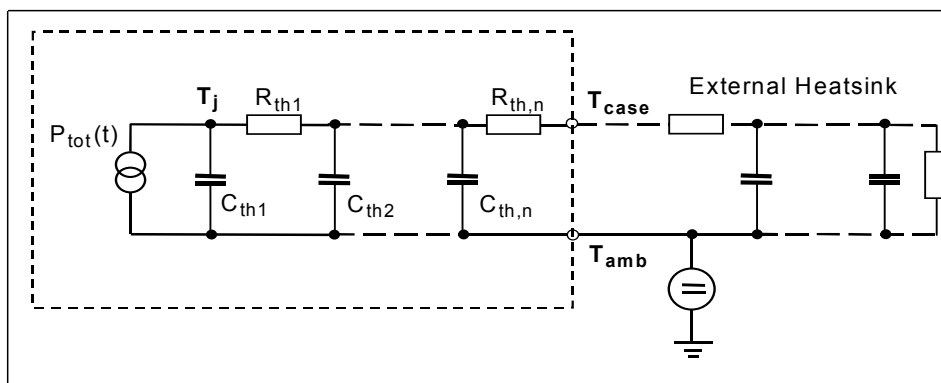

1 Power dissipation

$$P_{tot} = f(T_C)$$

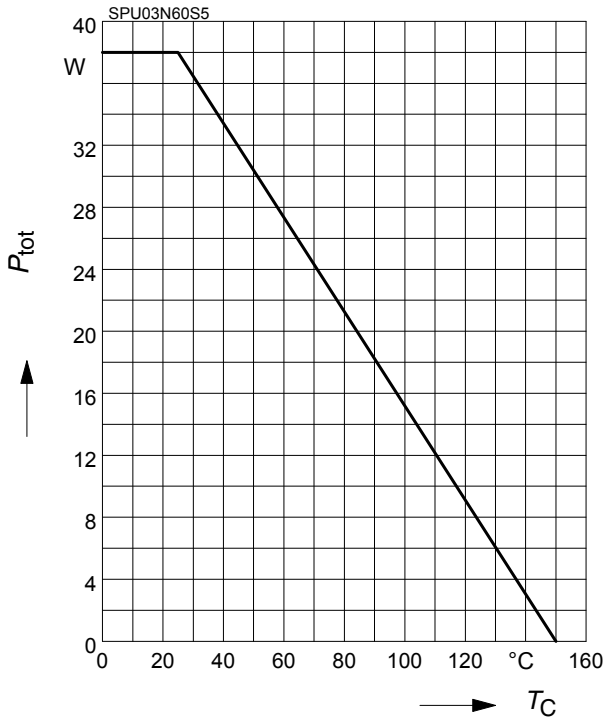

2 Safe operating area

$$I_D = f(V_{DS})$$

parameter : $D = 0$, $T_C = 25^\circ\text{C}$

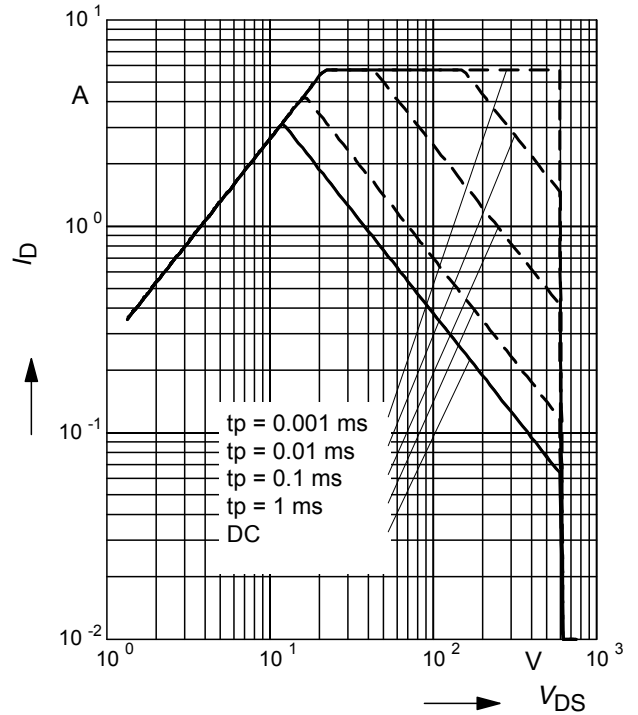

3 Transient thermal impedance

$$Z_{thJC} = f(t_p)$$

parameter: $D = t_p/T$

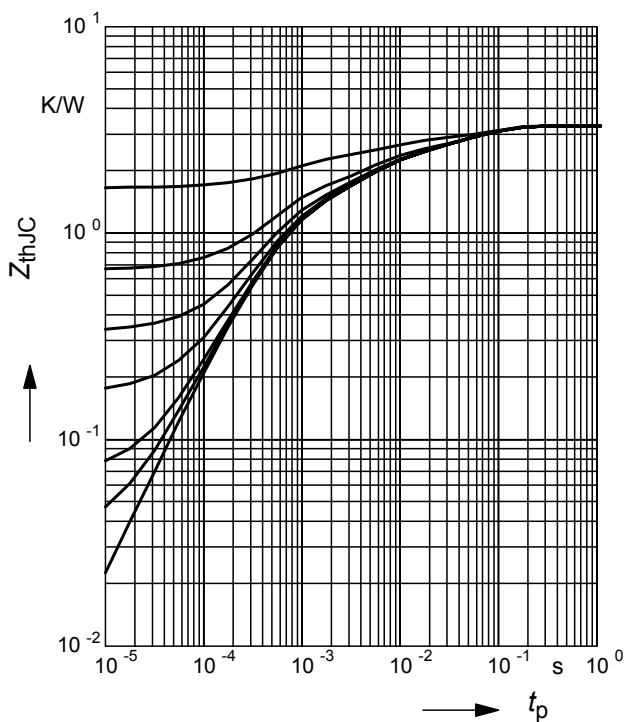

4 Typ. output characteristic

$$I_D = f(V_{DS}); T_j = 25^\circ\text{C}$$

parameter: $t_p = 10 \mu\text{s}$, V_{GS}

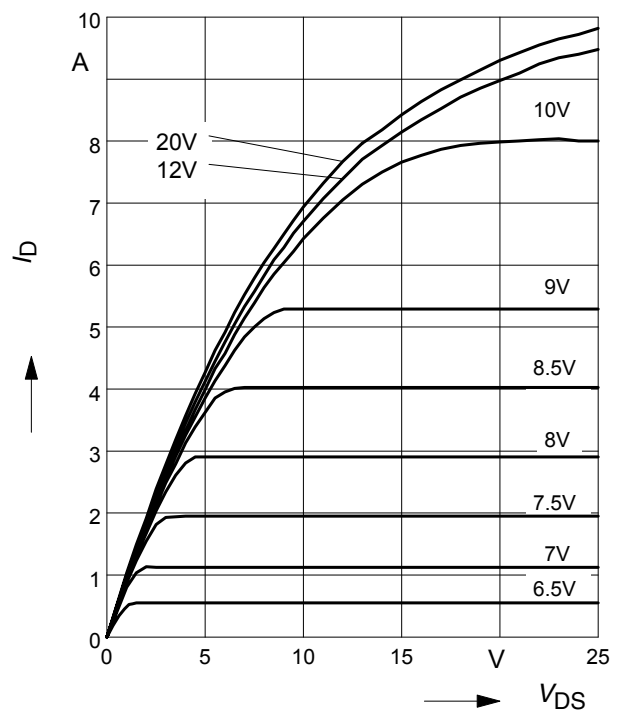

5 Drain-source on-state resistance

$$R_{DS(on)} = f(T_j)$$

parameter: $I_D = 2\text{ A}$, $V_{GS} = 10\text{ V}$

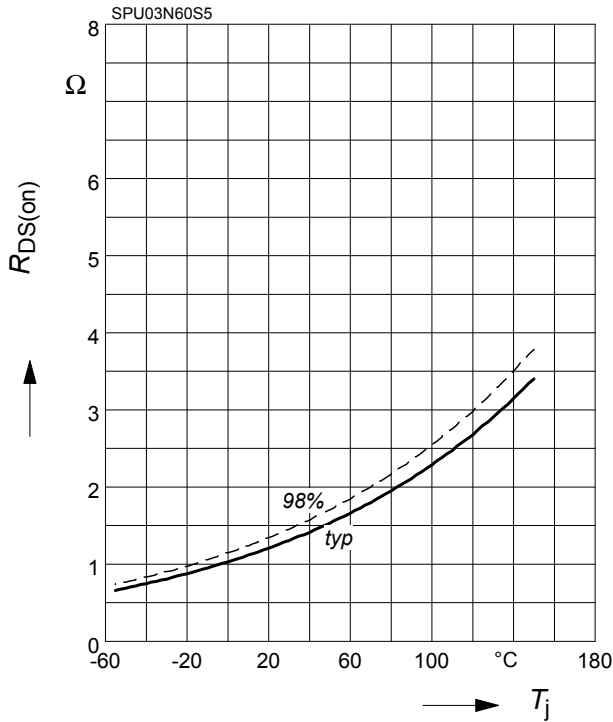

6 Typ. transfer characteristics

$$I_D = f(V_{GS}); V_{DS} \geq 2 \times I_D \times R_{DS(on)max}$$

parameter: $t_p = 10\text{ }\mu\text{s}$

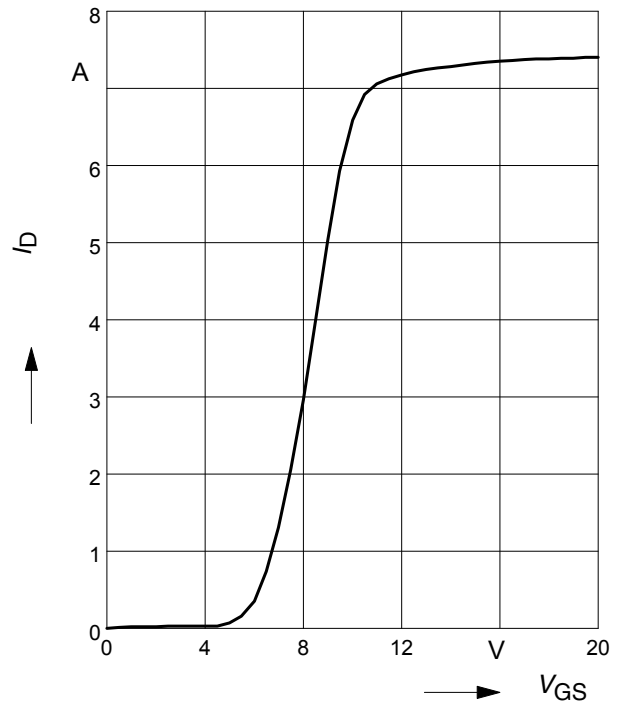

7 Typ. gate charge

$$V_{GS} = f(Q_{Gate})$$

parameter: $I_D = 3.2\text{ A pulsed}$

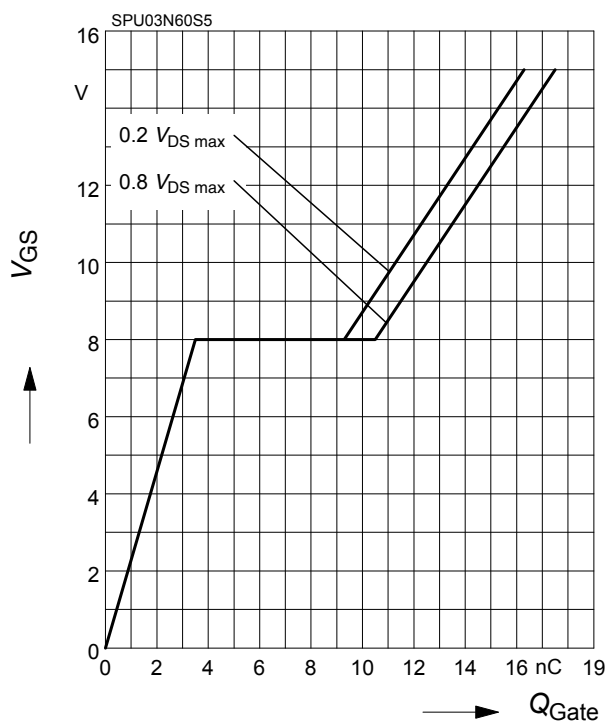

8 Forward characteristics of body diode

$$I_F = f(V_{SD})$$

parameter: T_j , $t_p = 10\text{ }\mu\text{s}$

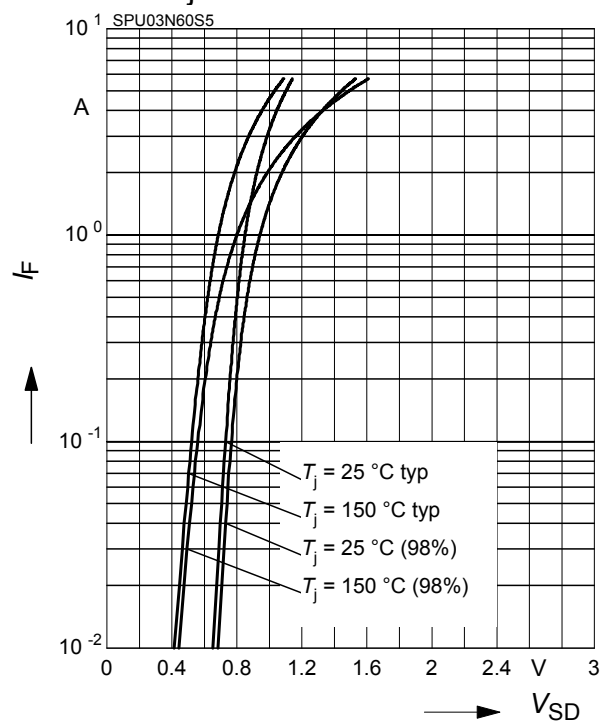

9 Avalanche SOA

$I_{AR} = f(t_{AR})$
par.: $T_j \leq 150\text{ °C}$

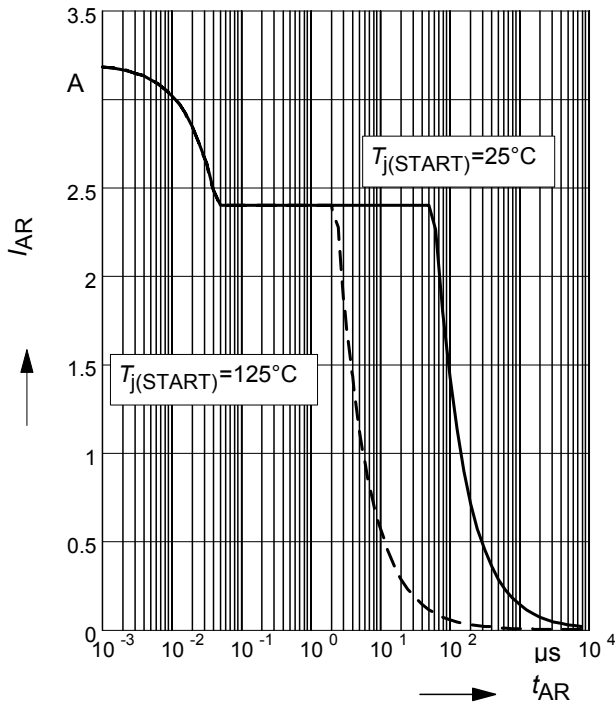

10 Avalanche energy

$E_{AS} = f(T_j)$
par.: $I_D = 2.4\text{ A}$, $V_{DD} = 50\text{ V}$

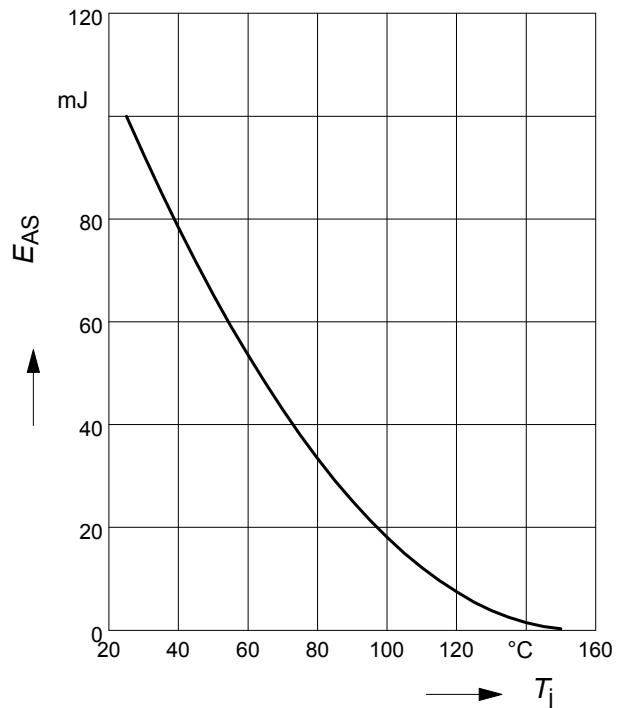

11 Drain-source breakdown voltage

$V_{(BR)DSS} = f(T_j)$

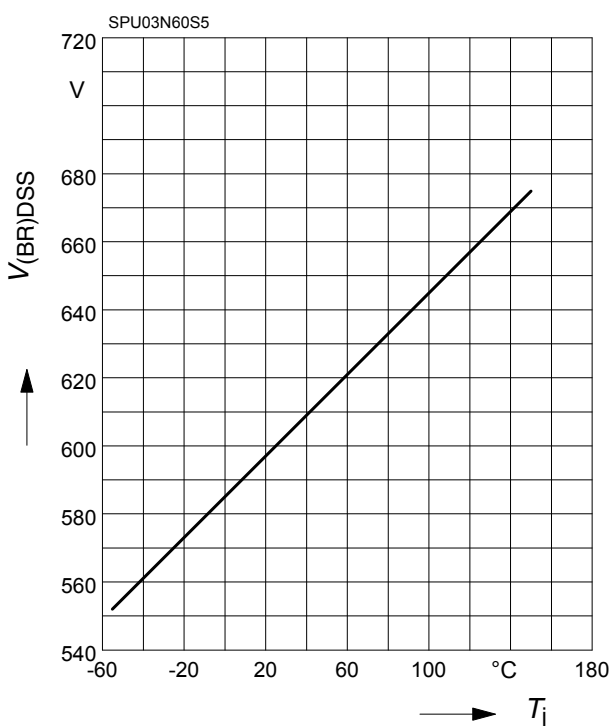

12 Typ. capacitances

$C = f(V_{DS})$
parameter: $V_{GS} = 0\text{ V}$, $f = 1\text{ MHz}$

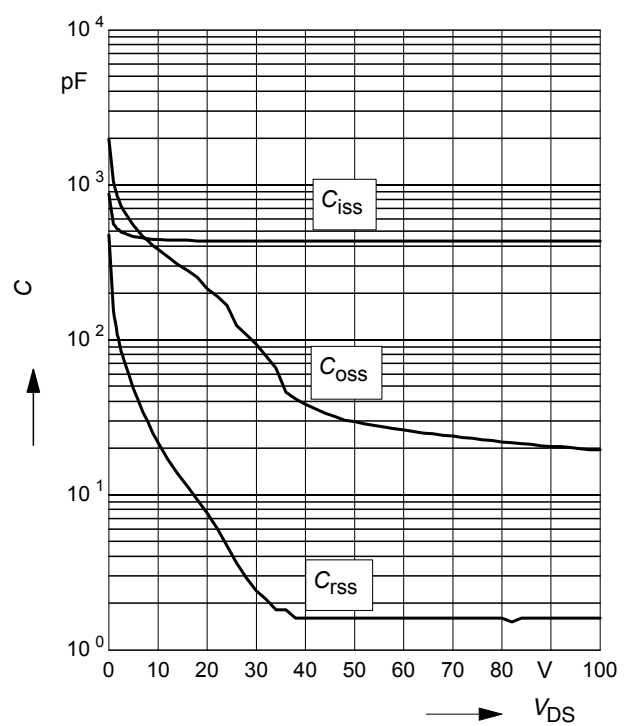

Definition of diodes switching characteristics



PG-TO252-3-1, PG-TO252-3-11, PG-TO252-3-21 (D-PAK)

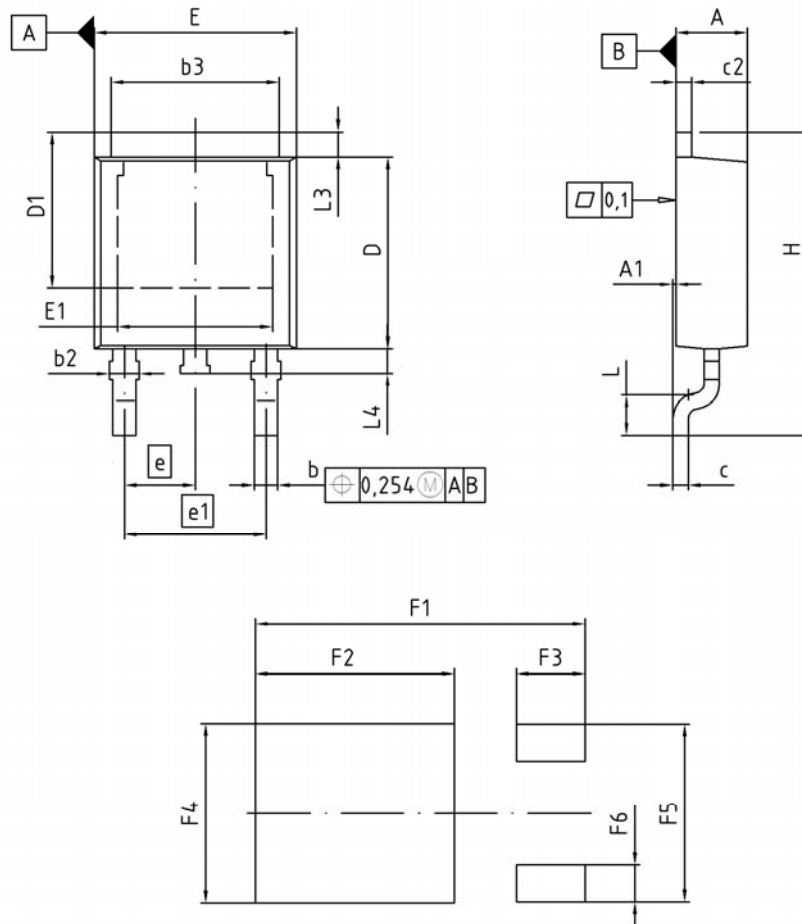

| DIM | MILLIMETERS | | INCHES | |
|-----|-------------|-------|--------|-------|
| | MIN | MAX | MIN | MAX |
| A | 2.16 | 2.41 | 0.085 | 0.095 |
| A1 | 0.00 | 0.15 | 0.000 | 0.006 |
| b | 0.64 | 0.89 | 0.025 | 0.035 |
| b2 | 0.65 | 1.15 | 0.026 | 0.045 |
| b3 | 5.00 | 5.50 | 0.197 | 0.217 |
| c | 0.46 | 0.60 | 0.018 | 0.024 |
| c2 | 0.46 | 0.98 | 0.018 | 0.039 |
| D | 5.97 | 6.22 | 0.235 | 0.245 |
| D1 | 5.02 | 5.84 | 0.198 | 0.230 |
| E | 6.40 | 6.73 | 0.252 | 0.265 |
| E1 | 4.70 | 5.21 | 0.185 | 0.205 |
| e | 2.29 | | 0.090 | |
| e1 | 4.57 | | 0.180 | |
| N | 3 | | 3 | |
| H | 9.40 | 10.48 | 0.370 | 0.413 |
| L | 1.18 | 1.70 | 0.046 | 0.067 |
| L3 | 0.90 | 1.25 | 0.035 | 0.049 |
| L4 | 0.51 | 1.00 | 0.020 | 0.039 |
| F1 | 10.50 | 10.70 | 0.413 | 0.421 |
| F2 | 6.30 | 6.50 | 0.248 | 0.256 |
| F3 | 2.10 | 2.30 | 0.083 | 0.091 |
| F4 | 5.70 | 5.90 | 0.224 | 0.232 |
| F5 | 5.66 | 5.86 | 0.223 | 0.231 |
| F6 | 1.10 | 1.30 | 0.043 | 0.051 |

DOCUMENT NO.
Z8B00003328

SCALE

EUROPEAN PROJECTION

ISSUE DATE
19-10-2007

REVISION
03

PG-TO251-3-1, PG-TO251-3-21 (I-PAK)

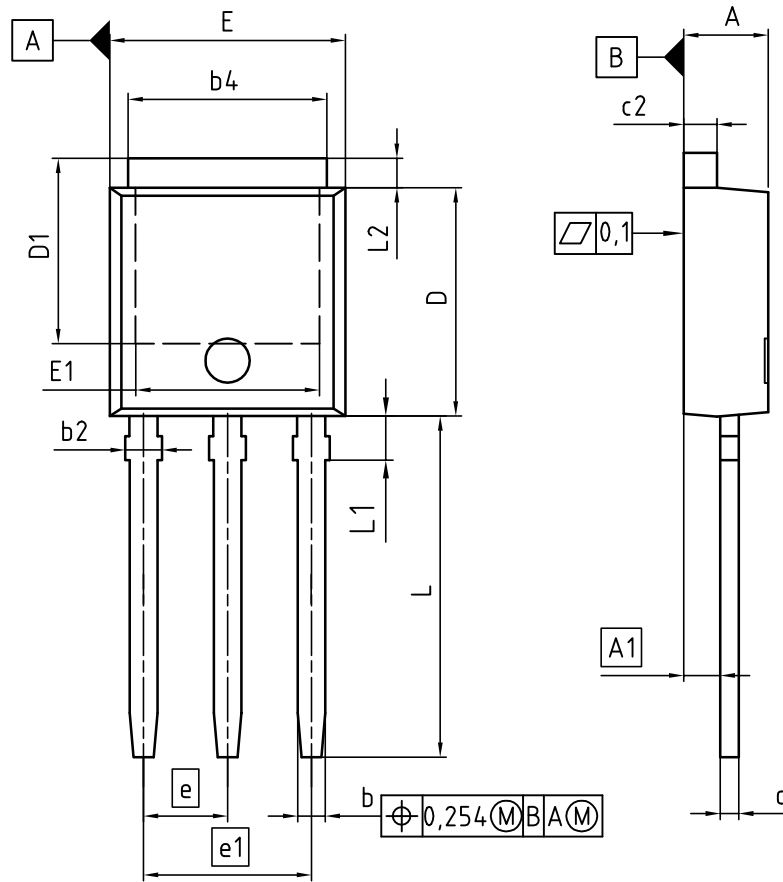

| DIM | MILLIMETERS | | INCHES | |
|-----|-------------|------|--------|-------|
| | MIN | MAX | MIN | MAX |
| A | 2.16 | 2.41 | 0.085 | 0.095 |
| A1 | 0.90 | 1.14 | 0.035 | 0.045 |
| b | 0.64 | 0.89 | 0.025 | 0.035 |
| b2 | 0.65 | 1.15 | 0.026 | 0.045 |
| b4 | 4.95 | 5.50 | 0.195 | 0.217 |
| c | 0.46 | 0.60 | 0.018 | 0.024 |
| c2 | 0.46 | 0.89 | 0.018 | 0.035 |
| D | 5.97 | 6.22 | 0.235 | 0.245 |
| D1 | 5.04 | 5.77 | 0.198 | 0.227 |
| E | 6.35 | 6.73 | 0.250 | 0.265 |
| E1 | 4.70 | 5.21 | 0.185 | 0.205 |
| e | 2.29 | | 0.090 | |
| e1 | 4.57 | | 0.180 | |
| N | 3 | | 3 | |
| L | 8.89 | 9.65 | 0.350 | 0.380 |
| L1 | 1.90 | 2.29 | 0.075 | 0.090 |
| L2 | 0.89 | 1.37 | 0.035 | 0.054 |

| |
|-----------------------------|
| DOCUMENT NO. Z8B00003330 |
| SCALE |
| EUROPEAN PROJECTION |
| ISSUE DATE 19-03-2008 |
| REVISION 03 |

Published by
Infineon Technologies AG
81726 Munich, Germany
© 2008 Infineon Technologies AG
All Rights Reserved.

Legal Disclaimer

The information given in this document shall in no event be regarded as a guarantee of conditions or characteristics. With respect to any examples or hints given herein, any typical values stated herein and/or any information regarding the application of the device, Infineon Technologies hereby disclaims any and all warranties and liabilities of any kind, including without limitation, warranties of non-infringement of intellectual property rights of any third party.

Information

For further information on technology, delivery terms and conditions and prices, please contact the nearest Infineon Technologies Office (www.infineon.com).

Warnings

Due to technical requirements, components may contain dangerous substances. For information on the types in question, please contact the nearest Infineon Technologies Office. Infineon Technologies components may be used in life-support devices or systems only with the express written approval of Infineon Technologies, if a failure of such components can reasonably be expected to cause the failure of that life-support device or system or to affect the safety or effectiveness of that device or system. Life support devices or systems are intended to be implanted in the human body or to support and/or maintain and sustain and/or protect human life. If they fail, it is reasonable to assume that the health of the user or other persons may be endangered.