

# PRODUCT SPECIFICATION

DATE : 03/22/2012

<b>cosmo</b> ELECTRONICS CORPORATION	Photocoupler : <b>K2010</b>	NO.60P01028	REV.
		SHEET 1 OF 6	3

## High Reliability Photocoupler

### ● Features

1. Current transfer ratio  
( CTR : Min. 60% at  $I_F=2\text{mA}$   $V_{CE}=5\text{V}$  )
2. High isolation voltage between input and output  
( Viso : 5000Vrms )
3. Compact dual-in-line package.
4. Pb free and RoHS compliant.
5. Agency Approvals
  - UL UL1577 / CUL C22.2 No.1 & NTC No.5, File No. E169586
  - VDE EN60747, File No.101347
  - FIMKO EN60065, File No.FI23149
  - FIMKO EN60950, File No.FI24584
  - SEMKO EN60065, File No.1016484
  - SEMKO EN60950, File No.1016433

### ● Application :

1. Registers, copies, automatic vending machines.
2. System appliances, measuring instruments.
3. Computer terminals, programmable controllers.
4. Communications, telephone, etc.
5. Electric home appliances, such as oil fan heaters, Microwave Oven, Washer, Refrigerator, Air conditioner, etc.
6. Medical instruments, physical and chemical equipment.
7. Signal transmission between circuits of different potentials and impedances.
8. Facsimile equipment, Audio, Video.
9. Switching power supply, Laser beam printer.

# PRODUCT SPECIFICATION

DATE : 03/22/2012

<b>cosmo</b> ELECTRONICS CORPORATION	Photocoupler :  <b>K2010</b>	NO.60P01028	REV.
		SHEET 2 OF 6	3

## ● Outside Dimension : Unit ( mm )

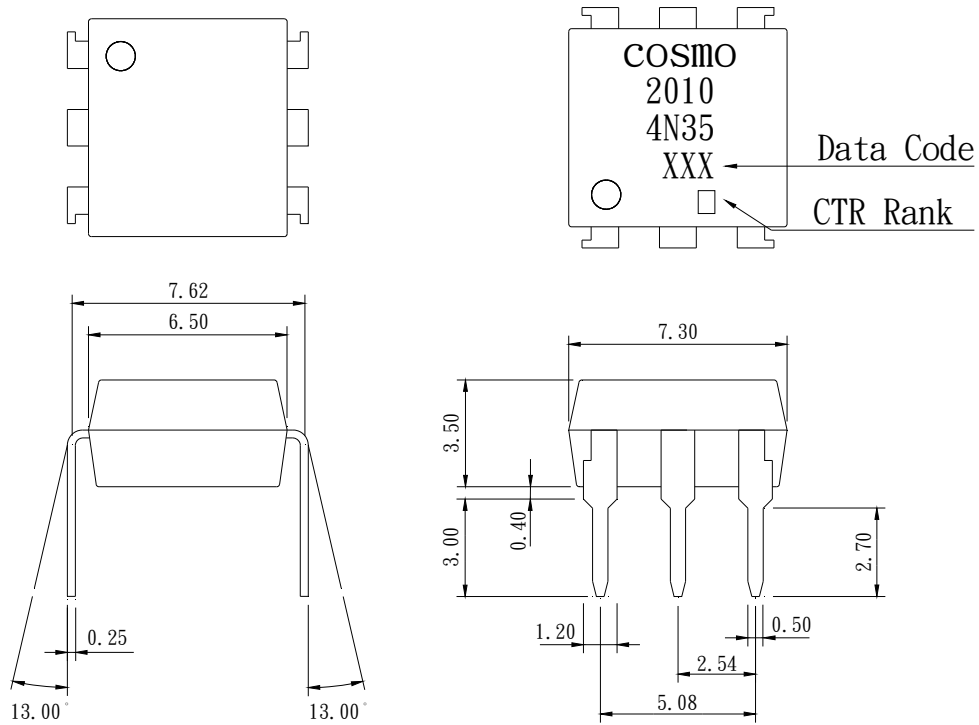

**TOLERANCE : ±0.2mm**

## ● Schematic : Top View

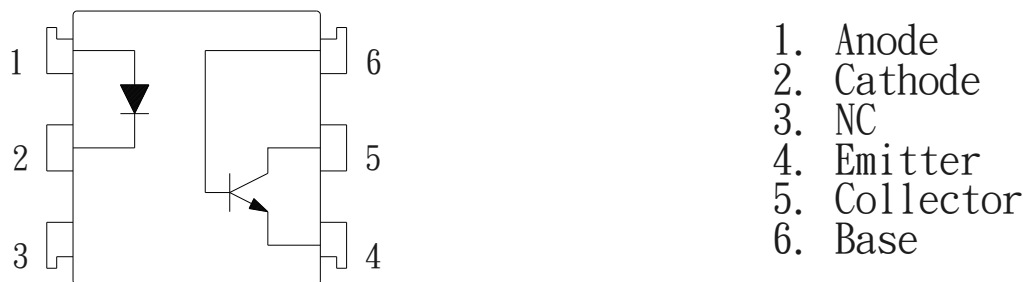

# PRODUCT SPECIFICATION

DATE : 03/22/2012

<b>cosmo</b> ELECTRONICS CORPORATION	Photocoupler : <b>K2010</b>	NO.60P01028	REV.
		SHEET 3 OF 6	3

## ● Absolute Maximum Ratings

Parameter		Symbol	Rating	Unit
Input	Forward current	$I_F$	50	mA
	Peak forward current	$I_{FM}$	1	A
	Reverse voltage	$V_R$	6	V
	Power dissipation	$P_D$	70	mW
Output	Collector-emitter voltage	$V_{CEO}$	80	V
	Emitter-collector voltage	$V_{ECO}$	6	V
	Collector-base voltage	$V_{CBO}$	60	V
	Emitter-base voltage	$V_{EBO}$	6	V
	Collector current	$I_C$	50	mA
	Collector power dissipation	$P_C$	150	mW
Total power dissipation		$P_{tot}$	200	mW
Isolation voltage 1 minute		$V_{iso}$	5000	Vrms
Operating temperature		$T_{opr}$	-55 to +115	°C
Storage temperature		$T_{stg}$	-55 to +125	°C
Soldering temperature 10 second		$T_{sol}$	260	°C

## ● Electro-optical Characteristics

Parameter		Symbol	Conditions	MIN.	TYP.	MAX.	Unit
Input	Forward voltage	$V_F$	$I_F=20mA$	-	1.2	1.4	V
	Peak forward voltage	$V_{FM}$	$I_{FM}=0.5A$	-	-	3.5	V
	Reverse current	$I_R$	$V_R=4V$	-	-	10	$\mu A$
	Terminal capacitance	$C_t$	$V=0, f=1KHz$	-	30	-	pF
Output	Collector dark current	$I_{CEO}$	$V_{CE}=20V$	-	-	0.1	$\mu A$
Transfer characteristics	Current transfer ratio	CTR	$I_F=2mA, V_{CE}=5V$	60	-	600	%
	Collector-emitter saturation	$V_{CE(sat)}$	$I_F=20mA, I_C=1mA$	-	0.1	0.3	V
	Isolation resistance	$R_{iso}$	DC500V	$5 \times 10^{10}$	$10^{11}$	-	$\Omega$
	Floating capacitance	$C_f$	$V=0, f=1MHz$	-	0.6	1.0	pF
	Cut-off frequency	$f_C$	$V_{CC}=5V, I_C=2mA, R_L=100\Omega$	-	80	-	KHz
	Response time ( Rise )	$t_r$	$V_{CE}=2V, I_C=2mA, R_L=100\Omega$	-	5	20	$\mu s$
	Response time ( Fall )	$t_f$		-	4	20	$\mu s$

# PRODUCT SPECIFICATION

DATE : 03/22/2012

<b>cosmo</b> ELECTRONICS CORPORATION	Photocoupler :	<b>NO.60P01028</b>	REV.
	<b>K2010</b>	<b>SHEET 4 OF 6</b>	<b>3</b>

Classification table of current transfer ratio is shown below.

Model No.	CTR (%)
K20101A	60 ~ 160
K20101B	130 ~ 260
K20101C	200 ~ 400
K20101D	300 ~ 600
K20101E	60 ~ 600

Fig.1 Current Transfer Ratio vs. Forward Current

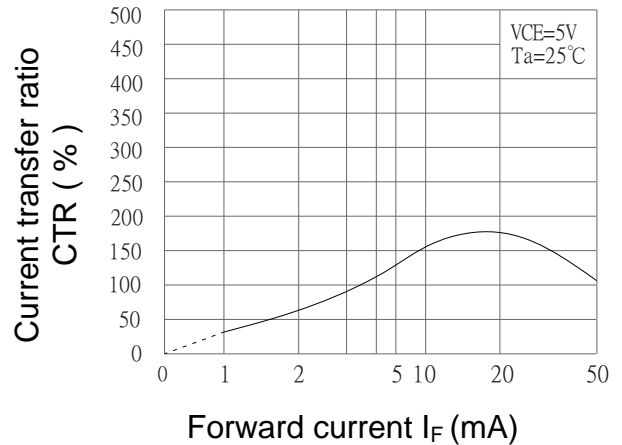

Fig.2 Collector Power Dissipation vs. Ambient Temperature

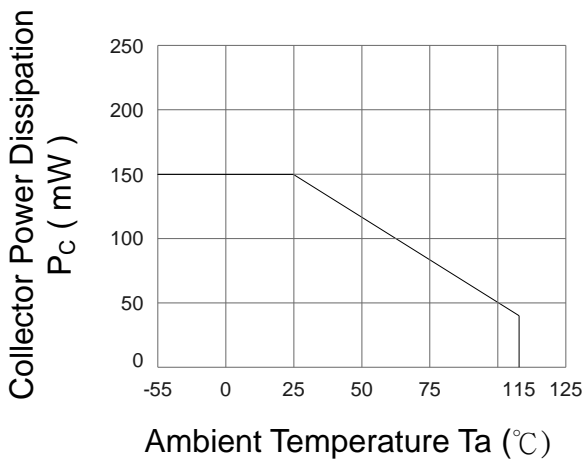

Fig.3 Collector Dark Current vs. Ambient Temperature

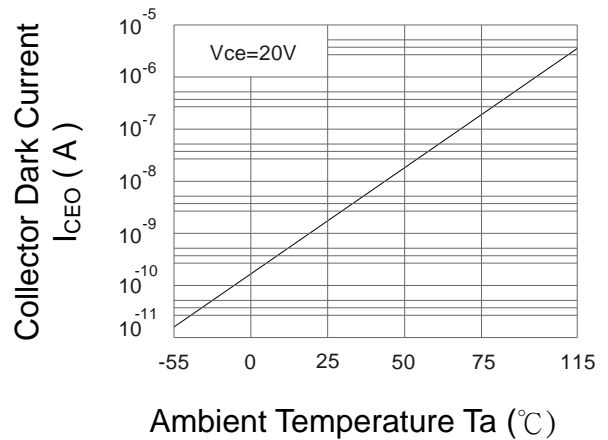

Fig.4 Forward Current vs. Ambient Temperature

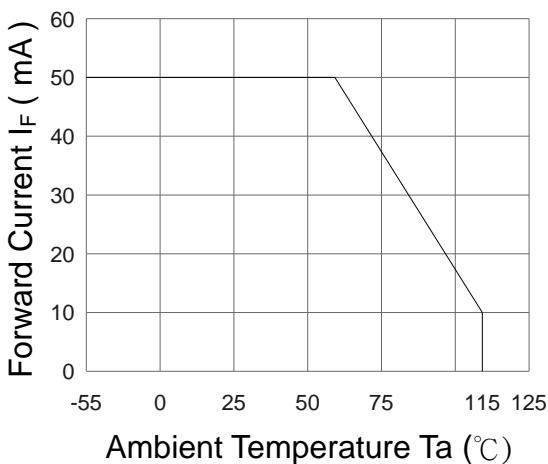
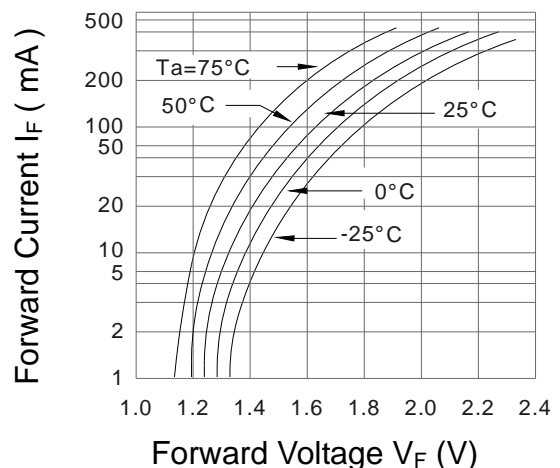

Fig.5 Forward Current vs. Forward Voltage



# PRODUCT SPECIFICATION

DATE : 03/22/2012

<b>cosmo</b> ELECTRONICS CORPORATION	Photocoupler : <b>K2010</b>	NO.60P01028	REV. 3
		SHEET 5 OF 6	

**Fig.6 Collector Current vs. Collector-Emitter Voltage**

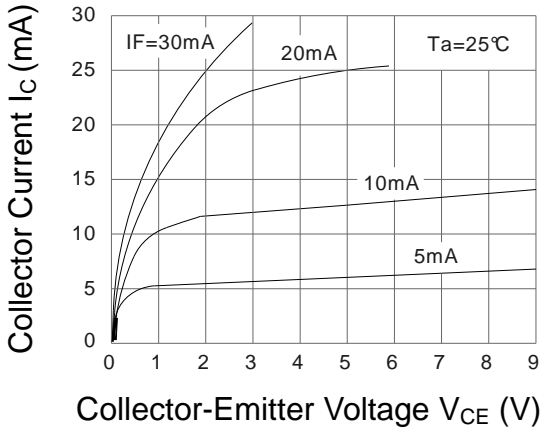

**Fig.7 Relative Current Transfer Ratio vs. Ambient Temperature**

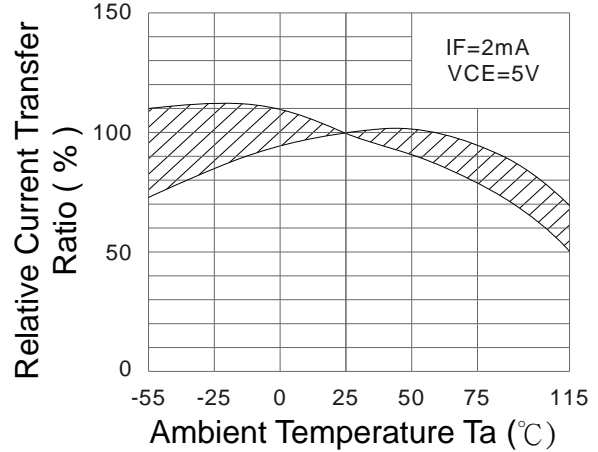

**Fig.8 Collector-Emitter Saturation Voltage vs. Ambient Temperature**

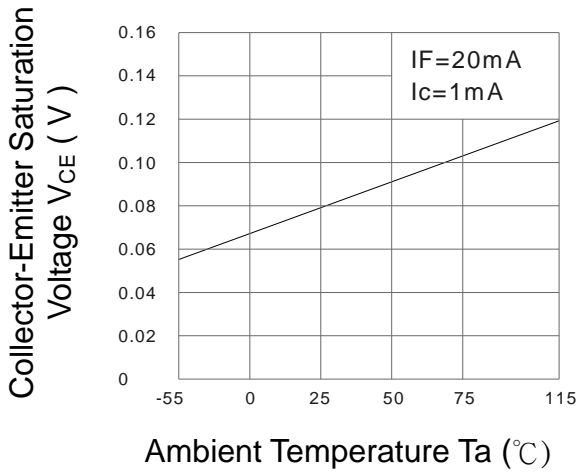

**Fig.9 Collector-Emitter Saturation Voltage vs. Forward Current**

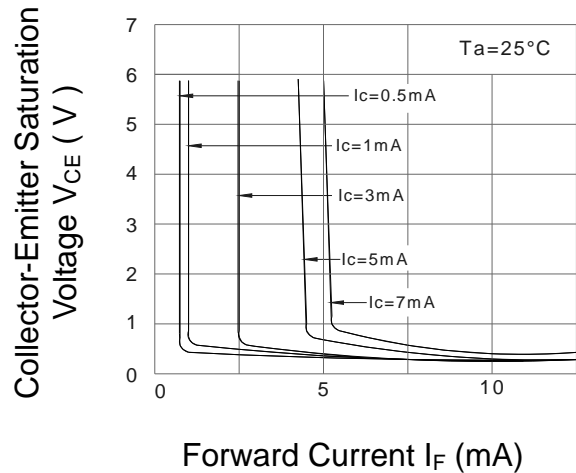

**Fig.10 Response Time vs. Load Resistance**

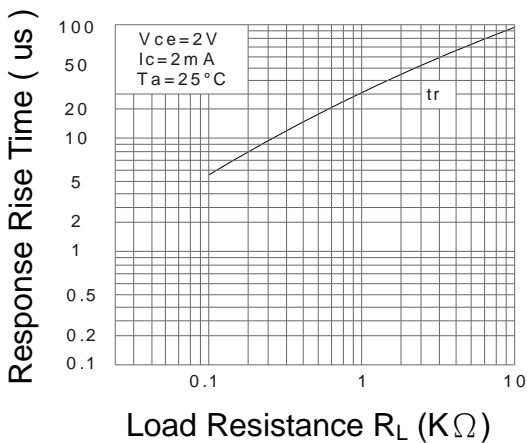

**Fig.11 Response Time vs. Load Resistance**

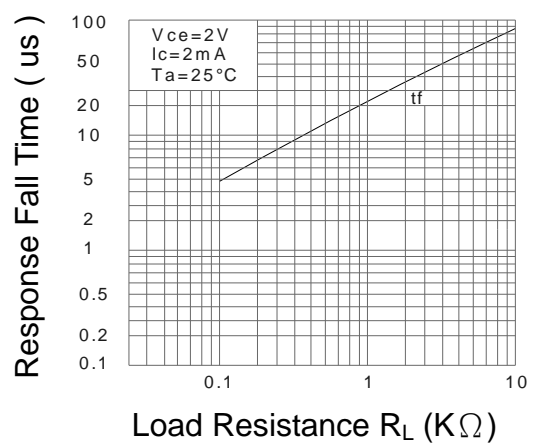

# PRODUCT SPECIFICATION

DATE : 03/22/2012

<b>cosmo</b> ELECTRONICS CORPORATION	Photocoupler : <b>K2010</b>	NO.60P01028	REV.
		SHEET 6 OF 6	3

## ● Notice

The information contained in this document is intended to be a general product description and is subject to change without notice. Please contact cosmo in order to obtain the latest device data sheets before using any cosmo device. cosmo does not assume any responsibility for use of any circuitry described. No circuit patent licenses are implied. This publication is the property of cosmo. No part of this publication may be reproduced or copied in any form or by any means, or transferred to any third party without the prior written consent of cosmo Electronics Corporation.

The devices listed in this document are designed for general applications only in electronic equipment. No devices shall be deployed which require higher level of reliability such as :

- Medical and other life support equipments.
- Space application.
- Telecommunication equipment ( trunk lines ).
- Nuclear power control equipment.

Unless it received prior written approval from cosmo.

cosmo takes no responsibility for damages arise form the improper usage of our device. Please contact cosmo for further information regarding the above notices.