

To all our customers

---

## **Regarding the change of names mentioned in the document, such as Hitachi Electric and Hitachi XX, to Renesas Technology Corp.**

---

The semiconductor operations of Mitsubishi Electric and Hitachi were transferred to Renesas Technology Corporation on April 1st 2003. These operations include microcomputer, logic, analog and discrete devices, and memory chips other than DRAMs (flash memory, SRAMs etc.) Accordingly, although Hitachi, Hitachi, Ltd., Hitachi Semiconductors, and other Hitachi brand names are mentioned in the document, these names have in fact all been changed to Renesas Technology Corp. Thank you for your understanding. Except for our corporate trademark, logo and corporate statement, no changes whatsoever have been made to the contents of the document, and these changes do not constitute any alteration to the contents of the document itself.

Renesas Technology Home Page: <http://www.renesas.com>

Renesas Technology Corp.  
Customer Support Dept.  
April 1, 2003

## Cautions

Keep safety first in your circuit designs!

1. Renesas Technology Corporation puts the maximum effort into making semiconductor products better and more reliable, but there is always the possibility that trouble may occur with them. Trouble with semiconductors may lead to personal injury, fire or property damage.

Remember to give due consideration to safety when making your circuit designs, with appropriate measures such as (i) placement of substitutive, auxiliary circuits, (ii) use of nonflammable material or (iii) prevention against any malfunction or mishap.

Notes regarding these materials

1. These materials are intended as a reference to assist our customers in the selection of the Renesas Technology Corporation product best suited to the customer's application; they do not convey any license under any intellectual property rights, or any other rights, belonging to Renesas Technology Corporation or a third party.
2. Renesas Technology Corporation assumes no responsibility for any damage, or infringement of any third-party's rights, originating in the use of any product data, diagrams, charts, programs, algorithms, or circuit application examples contained in these materials.
3. All information contained in these materials, including product data, diagrams, charts, programs and algorithms represents information on products at the time of publication of these materials, and are subject to change by Renesas Technology Corporation without notice due to product improvements or other reasons. It is therefore recommended that customers contact Renesas Technology Corporation or an authorized Renesas Technology Corporation product distributor for the latest product information before purchasing a product listed herein.  
The information described here may contain technical inaccuracies or typographical errors. Renesas Technology Corporation assumes no responsibility for any damage, liability, or other loss rising from these inaccuracies or errors.  
Please also pay attention to information published by Renesas Technology Corporation by various means, including the Renesas Technology Corporation Semiconductor home page (<http://www.renesas.com>).
4. When using any or all of the information contained in these materials, including product data, diagrams, charts, programs, and algorithms, please be sure to evaluate all information as a total system before making a final decision on the applicability of the information and products. Renesas Technology Corporation assumes no responsibility for any damage, liability or other loss resulting from the information contained herein.
5. Renesas Technology Corporation semiconductors are not designed or manufactured for use in a device or system that is used under circumstances in which human life is potentially at stake. Please contact Renesas Technology Corporation or an authorized Renesas Technology Corporation product distributor when considering the use of a product contained herein for any specific purposes, such as apparatus or systems for transportation, vehicular, medical, aerospace, nuclear, or undersea repeater use.
6. The prior written approval of Renesas Technology Corporation is necessary to reprint or reproduce in whole or in part these materials.
7. If these products or technologies are subject to the Japanese export control restrictions, they must be exported under a license from the Japanese government and cannot be imported into a country other than the approved destination.  
Any diversion or reexport contrary to the export control laws and regulations of Japan and/or the country of destination is prohibited.
8. Please contact Renesas Technology Corporation for further details on these materials or the products contained therein.

# HA16129FPJ

## Single Watchdog Timer



ADE-204-027B (Z)

Rev. 2

Mar. 2001

---

### Description

The HA16129FPJ is a watchdog timer IC that monitors a microprocessor for runaway. In addition to the watchdog timer function, the HA16129FPJ also provides a function for supplying a high-precision stabilized power supply to the microprocessor, a power on reset function, a power supply voltage monitoring function, and a fail-safe function that masks the microprocessor outputs if a runaway is detected.

### Functions

- Watchdog timer (WDT) function  
Monitors the P-RUN signal output by the microprocessor, and issues an auto-reset ( $\overline{\text{RES}}$ ) signal if a microprocessor runaway is detected.
- Stabilized power supply  
Provides power to the microprocessor.
- Power on and clock off functions  
The power on function outputs a low level signal to the microprocessor for a fixed period when power is first applied.  
The clock off function outputs a  $\overline{\text{RES}}$  signal to the microprocessor a fixed period after a runaway occurs.
- Power supply monitoring function  
When the reference voltage ( $V_{\text{out}}$ ) falls and becomes lower than the  $\overline{\text{NMI}}$  detection voltage (4.63 V, Typ) or the  $\overline{\text{STBY}}$  detection voltage (3.0 V Typ), this function outputs either an  $\overline{\text{NMI}}$  signal or an  $\overline{\text{STBY}}$  signal, respectively. Note that NMI detection can be set to monitor either  $V_{\text{CC}}$  or  $V_{\text{out}}$ .
- OUTE function\*<sup>1</sup> (fail-safe function)  
Outputs a signal used to mask microprocessor outputs when a microprocessor runaway has been detected.
- $\overline{\text{RES}}$  delay function  
Sets the delay between the time the  $\overline{\text{NMI}}$  signal is output and the time the  $\overline{\text{RES}}$  signal is output.
- Protection functions  
The HA16129FPJ incorporates both  $V_{\text{out}}$  overvoltage prevention and current limiter functions.

Note: 1. OUTE function: OUTE is an abbreviation for output enable.

## Features

- High-precision output voltage:  $5.0\text{ V} \pm 1.5\%$
- The WDT supports both frequency and duty detection schemes.
- High-precision power supply monitoring function:  $4.625\text{ V} \pm 0.125\text{ V}$
- Built-in OUTE function
- All functions can be adjusted with external resistors and/or capacitors.

## Pin Arrangement

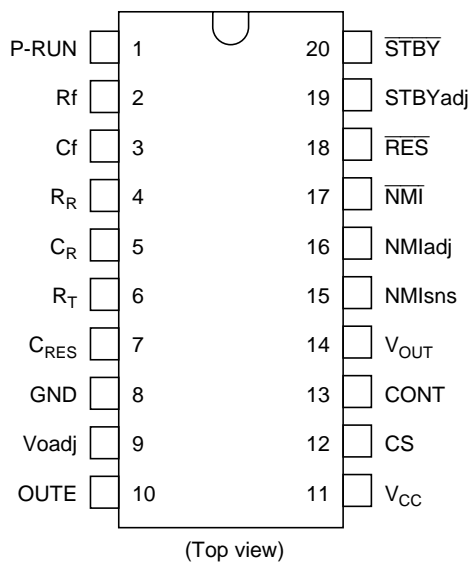

Block Diagram

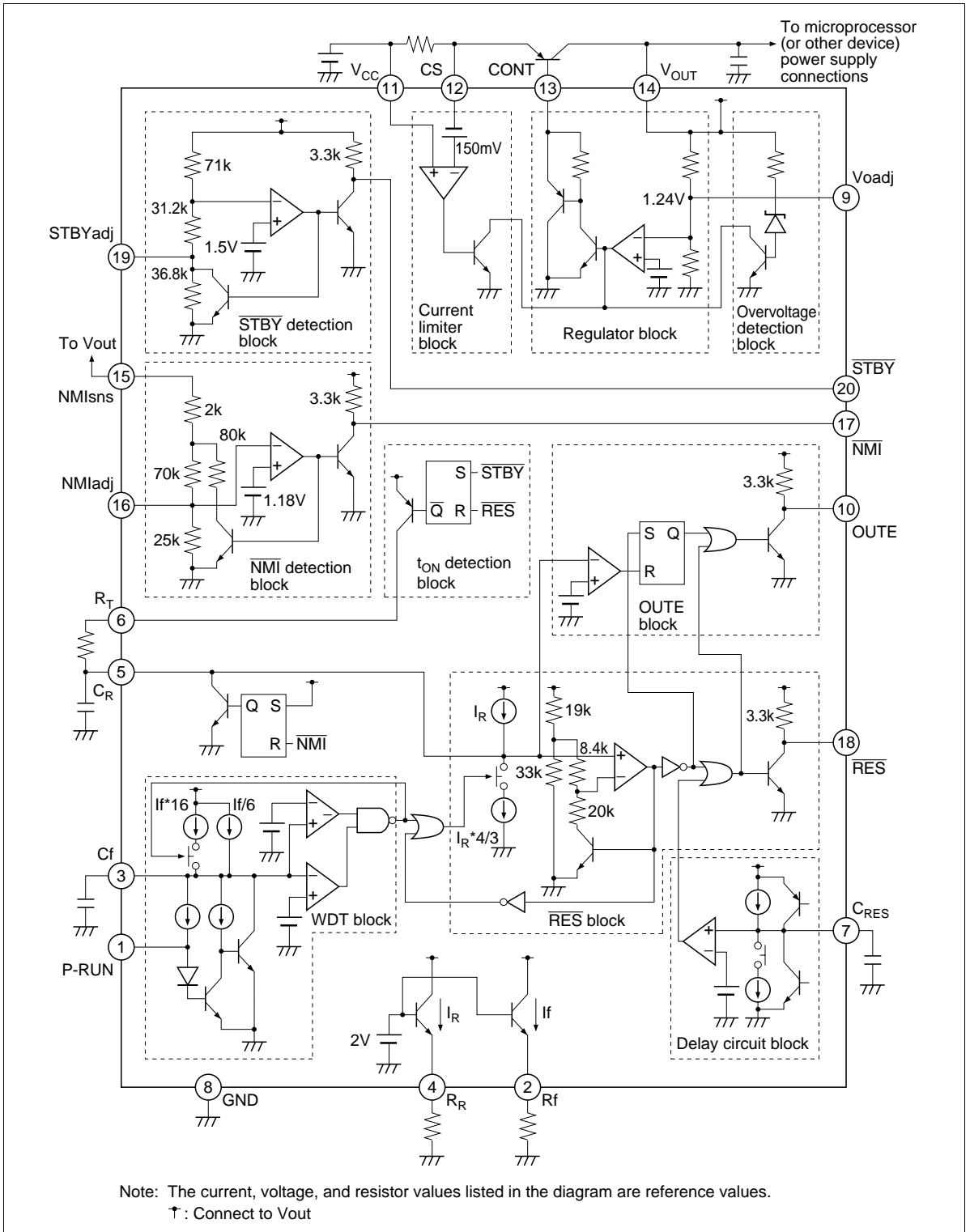

## Pin Function

Related Function	Pin No.	Symbol	Function
WDT.	1	P-RUN	Watchdog timer pulse input. The auto-reset function is controlled by the duty cycle or frequency of this input pulse signal.
	2	Rf	The resistor connected to this pin determines the current that flows in the Cf pin capacitor. Use the resistor value from 100 kΩ to 500 kΩ
	3	Cf	The current determined by the Rf pin charges the Cf capacitor and the potential on this pin determines the watchdog timer frequency band.
t <sub>RH</sub> , t <sub>RL</sub> , t <sub>OFF</sub>	4	R <sub>R</sub>	The resistor connected to this pin determines the current that flows in the C <sub>R</sub> pin capacitor. Use the resistor value from 100 kΩ to 500 kΩ
	5	C <sub>R</sub>	The current determined by the R <sub>R</sub> pin charges the capacitor C <sub>R</sub> and the potential on this pin controls the RES function (toff, t <sub>RH</sub> , and t <sub>RL</sub> ).
t <sub>ON</sub>	6	R <sub>T</sub>	The resistor R <sub>T</sub> , which determines only the time t <sub>ON</sub> for the RES function is connected to this pin. This resistor determines the current that charges the capacitor C <sub>R</sub> for the time t <sub>ON</sub> . Use the resistor value from 100 kΩ to 500 kΩ
tr, t <sub>RES</sub>	7	C <sub>RES</sub>	The current determined by the Rf pin charges the capacitor C <sub>RES</sub> , and the RES delay times (Tr and T <sub>RES</sub> ) are determined by the potential of this capacitor.
—	8	GND	Ground
Vout	9	Voadj	Insert the resistor Roadj if fine adjustment of the regulator output voltage Vout is required. Leave this pin open if Vout does not need to be changed.
Output	10	OUTE	Output for the OUTE function
Power supply	11	V <sub>CC</sub>	Power supply
Current limiter	12	CS	Current limiter detection. Connect the overcurrent detection resistor between the CS pin and the V <sub>CC</sub> pin. If this function is not used, short this pin to V <sub>CC</sub> . Also, connect this pin to the emitter of the external transistor. (This function can not operate when V <sub>OUT</sub> < 2 V)
Vout	13	CONT	Connect this pin to the base of the external transistor.
	14	V <sub>OUT</sub>	Provides the regulator output voltage and the IC internal power supply. Connect this pin to the collector of the external transistor.
NMI	15	NMIsns	This pin senses the NMI detection voltage. If V <sub>CC</sub> is to be detected, connect this pin to the V <sub>CC</sub> pin (however, note that an external resistor is required), and if Vout is to be detected, connect this pin to the V <sub>OUT</sub> pin.
	16	NMIadj	Insert a resistor if fine adjustment of the NMI detection voltage is required. Leave this pin open if fine adjustment is not required.
Output	17	NMI	NMI output
Output	18	RES	RES output
STBY	19	STBYadj	Insert a resistor if fine adjustment of the STBY detection voltage is required. Leave this pin open if fine adjustment is not required.
Output	20	STBY	STBY output

## Functional Description

This section describes the functions provided by the HA16129FPJ. See the section on formulas for details on adjustment methods.

### Regulator Block

#### Vout Voltage

This IC provides a stabilized 5 V power supply by controlling the base current of an external transistor. The largest current (the maximum CONT pin current) that can be drawn by the base of this external transistor is 20 mA. Also note that the Vout output is also used for the power supply for this IC's internal circuits.

### Current Limiter Block

When a current detection resistor ( $R_{CS}$ ) is connected between the  $V_{CC}$  pin and the CS pin, and the voltage between these pins exceeds the  $V_{CS}$  voltage (150 mV Typ), the CONT pin function turns off and the output voltage supply is stopped. This function can not work when  $V_{OUT} < 2$  V.

Note: This function is not short detection.

### Output Voltage (Vout) Adjustment

The output voltage can be adjusted by connecting an external resistor at the output voltage adjustment pin (Voadj). However, if for some reason the voltage on this Vout line increases and exceeds the voltage adjustment range (7 V Max), the CONT pin function turns off and the output voltage supply is stopped.

Refer to the timing charts in conjunction with the following items.

### LVI (Low Voltage Inhibit)

#### $\overline{NMI}$ Detection Voltage

This function monitors for drops in the power-supply voltage. This function can be set up to monitor either  $V_{CC}$  or Vout. When Vout is monitored, a low level is output from the  $\overline{NMI}$  pin if that voltage falls under the detection voltage (4.63 V Typ). Then, when the power-supply voltage that fell rises again, the  $\overline{NMI}$  pin will output a high level. Note that this function has a fixed hysteresis of 50 mV (Typ). The monitored power supply is selected by connecting the NMIsns pin either to the  $V_{CC}$  pin or to the  $V_{OUT}$  pin. When detecting  $V_{CC}$ , an external adjustment resistor is required.)

The detection voltage can also be adjusted with the NMIadj pin.

#### $\overline{STBY}$ Detection Voltage

This function monitors for drops in the Vout voltage. It monitors the Vout voltage, and outputs a low level from the  $\overline{STBY}$  pin if that voltage drops below the detection voltage (3.0 V Typ). Then, when the power-supply voltage that fell rises again, the  $\overline{STBY}$  pin will output a high level. Note that this function has a fixed hysteresis of 1.35 V (Typ).

The detection voltage can also be adjusted with the STBYadj pin.

## Function Start Voltage

This is the minimum required Vout voltage for the  $\overline{\text{RES}}$ ,  $\overline{\text{NMI}}$ ,  $\overline{\text{STBY}}$ , and OUTE output pin functions to start operating. It is stipulated as the voltage that Vout must reach after power is first applied for these pins to output a low level.

## Hysteresis

This is the difference between the LVI function detection voltage when the power-supply voltage drops, and the clear (reset) voltage when the power-supply voltage rises.

$$(V_{\text{HYSN}} = V_{\text{NMI}}' - V_{\text{NMI}}; V_{\text{HYSS}} = V_{\text{STBY}}' - V_{\text{STBY}})$$

## OUTE Function

When a microprocessor is in the runaway state, its outputs are undefined, and thus it is possible that the outputs may be driven by incorrect signals. This function is used to mask such incorrect microprocessor outputs. When the WDT function recognizes normal operation (when the  $\overline{\text{RES}}$  output is high), the OUTE output will be held high. When the WDT function recognizes an abnormal state and an auto-reset pulse is output from the  $\overline{\text{RES}}$  pin, the OUTE output will be held low. Thus microprocessor outputs during microprocessor runaway can be masked by taking the AND of those outputs and this signal using external AND gates.

The OUTE output will go high when the  $C_R$  pin voltage exceeds VthHcr2, and will go low when that voltage falls below VthLcr.

There are limitation that apply when the OUTE function is used. Refer to the calculation formulas item for details.

## RES Function

$t_{\text{RH}}$

This period is the length of the high-level output period of the  $\overline{\text{RES}}$  pulse when the P-RUN signal from the microprocessor stops. This is the time required for the  $C_R$  potential to reach VthLcr from VthHcr1.

$t_{\text{RL}}$

This period is the length of the low-level output period of the  $\overline{\text{RES}}$  pulse when the P-RUN signal from the microprocessor stops. This is the time required for the  $C_R$  potential to reach VthHcr1 from VthLcr.

$t_{\text{OFF}}$

This is the time from the point the P-RUN signal from the microprocessor stops to the point a low level is output from the  $\overline{\text{RES}}$  pin. During normal microprocessor operation, the potential on the  $C_R$  pin will be about Vout – 0.2 V (although this value may change with the P-RUN signal input conditions, so it should be verified in the actual application circuit) and  $t_{\text{OFF}}$  is the time for the  $C_R$  pin potential to reach VthLcr from that potential.



$t_{ON}$ 

$t_{ON}$  is the time from the point the  $\overline{NMI}$  output goes high when power is first applied to the point the  $\overline{RES}$  output goes low.  $t_{ON}$  is the time for the potential of the  $C_R$  pin to reach  $V_{thHcr1}$  from 0 V.

 $t_r$ 

The time  $t_r$  is the fixed delay time between the point the  $\overline{NMI}$  output goes from low to high after the power-supply voltage comes up to the point  $\overline{RES}$  goes from low to high. The time  $t_r$  is the time for the  $C_{RES}$  pin potential to fall from the high voltage (about 1.9 V) to  $V_{thres}$ .

 $t_{RES}$ 

The time  $t_{RES}$  is the fixed delay time between the point the  $\overline{NMI}$  output goes from high to low when the power-supply voltage falls to the point  $\overline{RES}$  goes from high to low. The time  $t_{RES}$  is the time for the  $C_{RES}$  pin potential to rise from 0 V to  $V_{thres}$ .

### WDT Function

This function determines whether the microprocessor is operating normally or has entered a runaway state by monitoring the duty or frequency of the P-RUN signal. When this function recognizes a runaway state, it outputs a reset pulse from the  $\overline{RES}$  pin and sets the OUTE pin to low from high. It holds the  $\overline{RES}$  and OUTE pins fixed at high as long as it recognizes normal microprocessor operation.

In this function, the potential of the  $C_f$  capacitor is controlled by the P-RUN signal. This  $C_f$  pin potential charges the capacitor  $C_R$  that controls the reset pulse to be between  $V_{thLcf}$  and  $V_{thHcf}$ . The judgment as to whether or not the microprocessor is operating normally, is determined by the balance between the charge and discharge voltage on the capacitor  $C_R$  at this time.

## Calculation Formulas

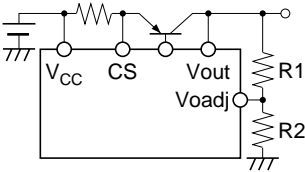
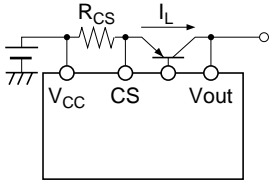
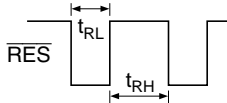
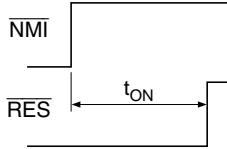
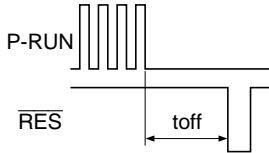
Item	Formula	Notes
Reference voltage	$V_{out} = 1.225 \left( 1 + \frac{37 \parallel R1}{12 \parallel R2} \right)$ R1, R2; kΩ	While the Vout voltage will be 5 V ±1.5% when the Voadj pin is open, the circuit shown here should be used to change the Vout voltage externally. 
Current limiter voltage	$V_{CS} (150 \text{ mV Typ}) < I_L \cdot R_{CS}$	When this function operates, the base current to the external transistor connected to the CS pin stops and the Vout output is lowered. 
OVP	—	This function prevents the microprocessor from being damaged if the Vout voltage is inadvertently increased to too high a level. The OVP detection voltage is fixed.
t <sub>RH</sub> , t <sub>RL</sub>	$t_{RH} = 3.3 \times C_R \cdot R_R$ $t_{RL} = 1.1 \times C_R \cdot R_R$	These determine the reset pulse frequency and duty. 
t <sub>ON</sub>	$t_{ON} = 1.1 \times C_R \cdot R_T$	Sets the time from the rise of the NMI signal to the point the RES output is cleared. 
t <sub>OFF</sub>	$t_{OFF} = 6.5 \times C_R \cdot R_R$	Sets the time from the point the P-RUN pulse stops to the point a reset pulse is output. 

Calculation Formulas (cont)

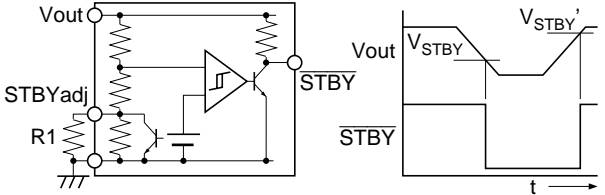
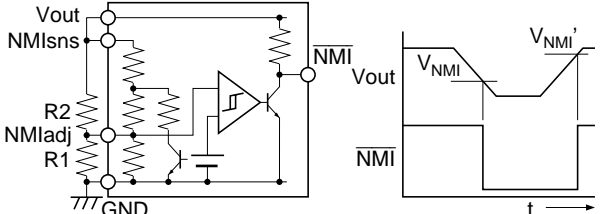
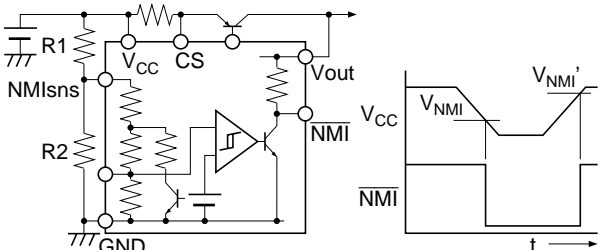
Item	Formula	Notes	
$V_{STBY}$	$V_{STBY} = 1.48 \times \left( \frac{67.6}{29.5 + 36.2 // R1} + 1 \right)$	<p>The voltage at which the <math>\overline{STBY}</math> signal is output when <math>V_{out}</math> falls. The <math>\overline{STBY}</math> detection voltage can be adjusted by connecting a resistor between the STBYadj pin and ground (R3). However, the <math>\overline{STBY}</math> recovery voltage cannot be adjusted.</p>	
	$V_{NMI}$ ( $V_{out}$ detection)	$V_{NMI} = 1.2 \times \left( 1 + \frac{R1 // 73}{R2 // 25} \right)$ <p>R1, R2; k<math>\Omega</math></p>	<p>The voltage at which the <math>\overline{NMI}</math> signal is output when <math>V_{out}</math> falls. (When NMI<sub>sns</sub> is connected to <math>V_{out}</math>.)</p> <p>The <math>\overline{NMI}</math> detection voltage can be adjusted by connecting resistors between the NMI<sub>adj</sub> pin and <math>V_{out}</math> (R1), and between the NMI<sub>pin</sub> and ground (R2).</p>
	$V_{NMI}$ ( $V_{CC}$ detection)	$V_{NMI} = 4.62 \times \left( \frac{R1}{R2 // 97.1} + 1 \right)$ <p>Recovery voltage</p> $V_{NMI} = 4.68 \times \left( \frac{R1}{R2 // 45.5} + 1 \right)$ <p>R1, R2; k<math>\Omega</math></p>	<p>The voltage at which the <math>\overline{NMI}</math> signal is output when <math>V_{CC}</math> falls. (When NMI<sub>sns</sub> is connected to <math>V_{CC}</math>.)</p> <p>The <math>\overline{NMI}</math> detection voltage can be adjusted by connecting resistors between the NMI<sub>sns</sub> pin and <math>V_{CC}</math> (R1), and between the NMI<sub>sns</sub> pin and ground (R2).</p>
	OUTE	$C_R \times R_R > 19.3 \times C_f \times R_f$	<p>If the OUTE function is used, the relationship shown at the left must be fulfilled to assure that pulses are not incorrectly generated in this output when a microprocessor runaway state is detected.</p>

## Calculation Formulas (cont)

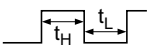
Item	Formula	Notes
WDT.	$f_{\text{Line1}} = \frac{0.31 \times (\text{Du} - 24)}{\text{Cf} \cdot \text{Rf}}$ $f_{\text{Line2}} = 24\% \text{ (fixed)}$ $f_{\text{Line3}} = \frac{0.024}{\text{Cf} \cdot \text{Rf}}$ $f_{\text{Line4}} = 99\%$ <p data-bbox="252 417 519 469">The relationship between <math>f_{\text{Line1}}</math> and <math>f_{\text{Line3}}</math></p> $f_{\text{Line1}} = f_{\text{Line3}} \times 12.9 (\text{Du} - 24)$ <p data-bbox="252 537 583 558">Du: The P-RUN signal duty cycle</p> <div data-bbox="258 574 580 624" style="display: flex; align-items: center;">  <math display="block">\text{Du} = \frac{t_H}{t_H + t_L} \times 100</math> </div>	<p>The WDT function judges whether the P-RUN pulse signal is normal or not. If the WDT function judges the P-RUN pulse signal to be abnormal, it outputs a reset signal. The normal range is the area enclosed by <math>f_{\text{Line1}}</math> to <math>f_{\text{Line4}}</math> in the figure.</p>

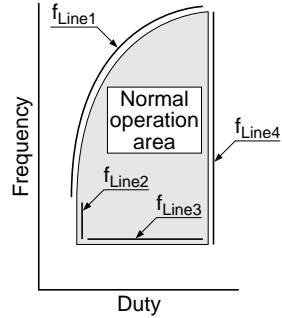

## Timing Charts

### Whole system timing chart

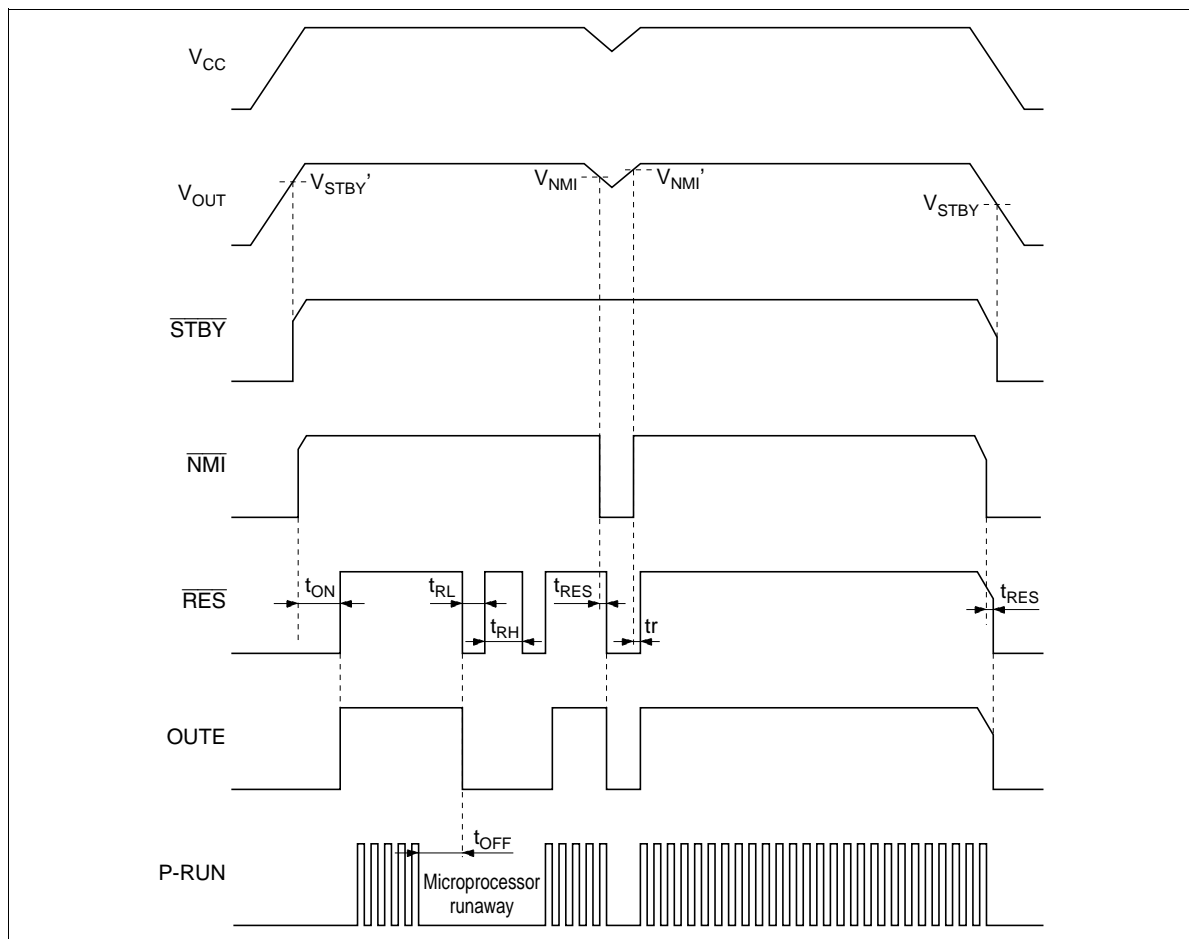

## WDT. timing chart

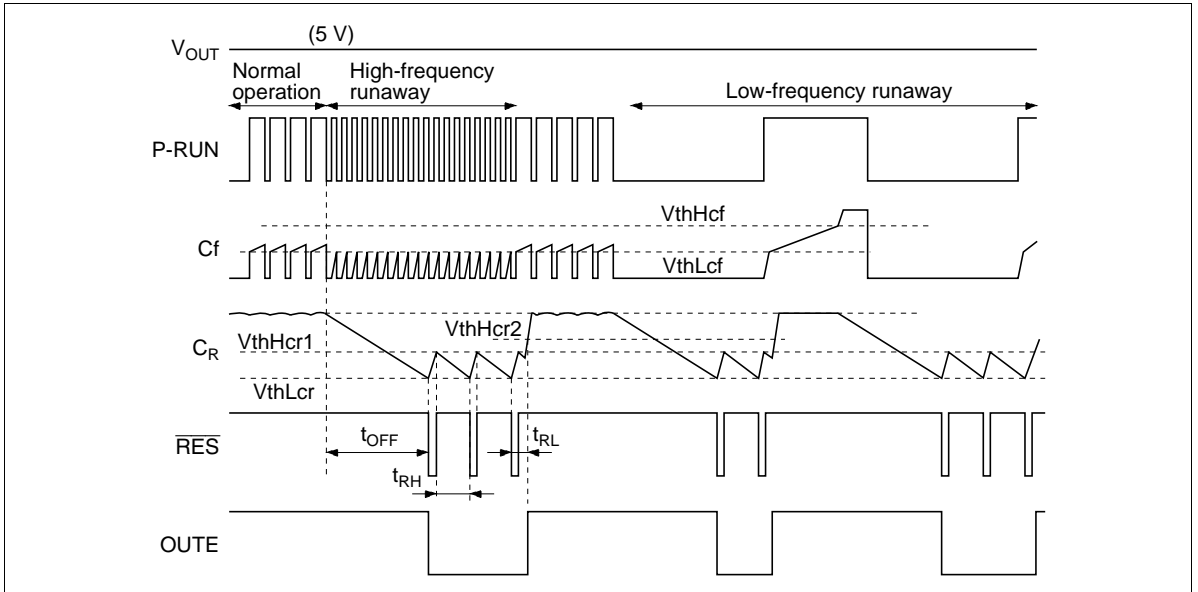

## LVI timing chart

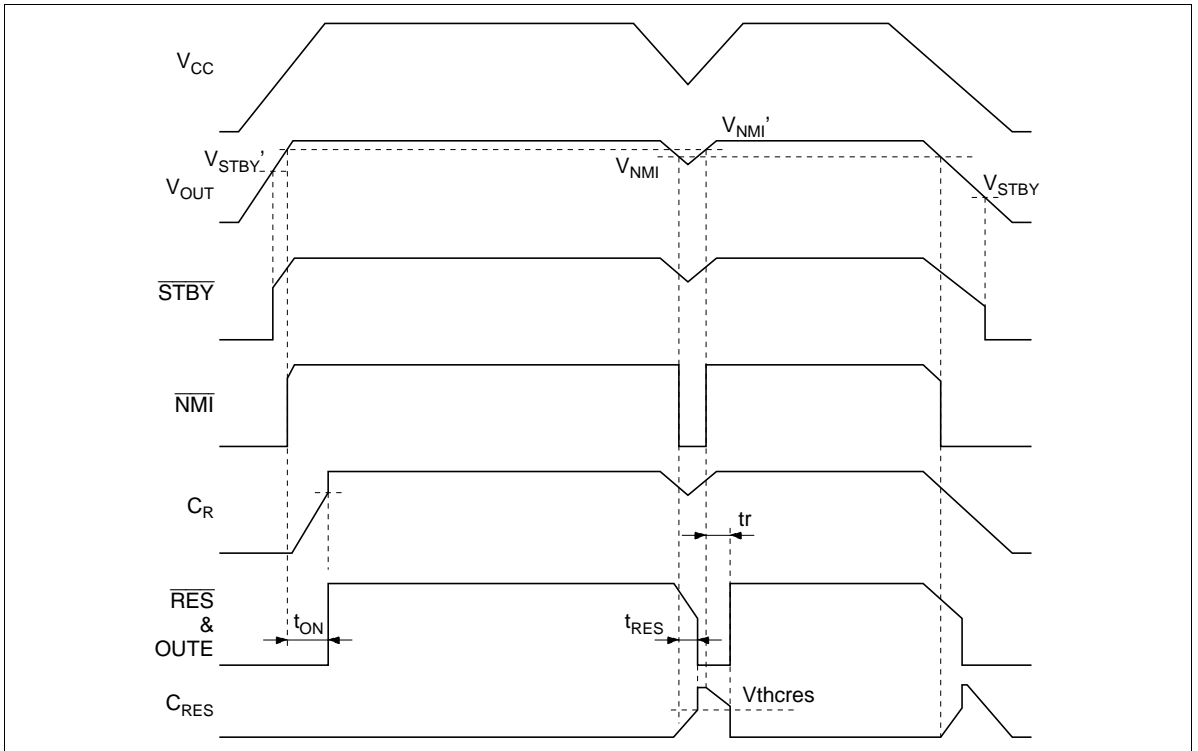

## Absolute Maximum Ratings (Ta = 25°C)

Item	Symbol	Rating	Unit
Power supply voltage	V <sub>CC</sub>	40	V
CS pin voltage	V <sub>CS</sub>	V <sub>CC</sub>	V
CONT pin current	I <sub>cont</sub>	20	mA
CONT pin voltage	V <sub>cont</sub>	V <sub>CC</sub>	V
Vout pin voltage	V <sub>out</sub>	12	V
P-RUN pin voltage	V <sub>PRUN</sub>	V <sub>out</sub>	V
NMI <sub>sns</sub> pin voltage	V <sub>NMI<sub>sns</sub></sub>	V <sub>CC</sub>	V
$\overline{\text{NMI}}$ pin voltage	V <sub>NMI</sub>	V <sub>out</sub>	V
$\overline{\text{STBY}}$ pin voltage	V <sub>STBY</sub>	V <sub>out</sub>	V
$\overline{\text{RES}}$ pin voltage	V <sub>RES</sub>	V <sub>out</sub>	V
OUTE pin voltage	V <sub>OUTE</sub>	V <sub>out</sub>	V
Power dissipation <sup>*1</sup>	P <sub>T</sub>	400	mW
Operating temperature	T <sub>opr</sub>	-40 to +85	°C
Storage temperature	T <sub>stg</sub>	-50 to +125	°C

Note: 1. This is the allowable value when mounted on a 40 × 40 × 1.6 mm glass-epoxy printed circuit board with a mounting density of 10% at ambient temperatures up to Ta = 77°C. This value must be derated by 8.3 mW/°C above that temperature.

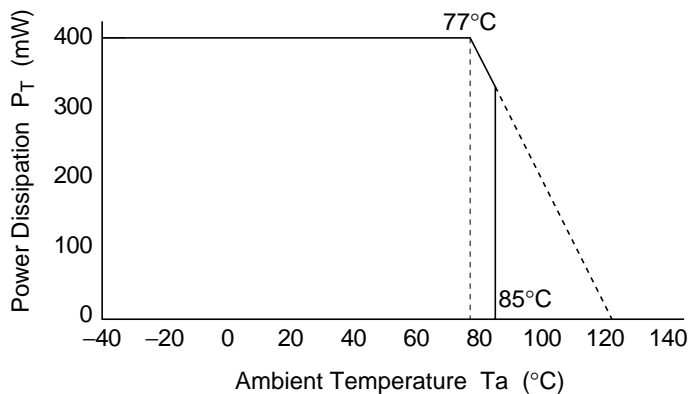

**Electrical Characteristics** ( $T_a = 25^\circ\text{C}$ ,  $V_{CC} = 12\text{V}$ ,  $V_{out} = 5.0\text{V}$ ,  $R_f = R_R = 180\text{k}\Omega$ ,  $C_f = 3300\text{pF}$ ,  $C_R = 0.1\mu\text{F}$ ,  $R_T = 390\text{k}\Omega$ ,  $C_{RES} = 1500\text{pF}$ ,  $R_{CS} = 0.2\Omega$ )

Item	Symbol	Min	Typ	Max	Unit	Test conditions	
Power supply current	$I_{CC}$	—	10	15	mA		
Current limiter voltage	$V_{CS}$	100	150	200	mV	$V_{CS} = (V_{CC} \text{ pin voltage} - \text{CS pin voltage})$	
Regulator block	Output voltage	$V_{out}$	4.925	5.00	5.075	V	$V_{CC} = 12\text{V}$ , $I_{cont} = 5\text{mA}$
	Input voltage stabilization	$V_{olin}$	-30	—	30	mV	$V_{CC} = 6 \text{ to } 17.5\text{V}$ , $I_{cont} = 10\text{mA}$
	Load current stabilization	$V_{oload}$	-30	—	30	mV	$I_{cont} = 0.1 \text{ to } 15\text{mA}$
	Ripple exclusion ratio	$R_{REJ}$	(45)	75	—	dB	$V_i = 0.5\text{V}_{rms}$ , $f_i = 1\text{kHz}$
	Output voltage temperature coefficient	$ \delta V_{out}/\delta T $	—	40	(200)	ppm/ $^\circ\text{C}$	$I_{cont} = 5\text{mA}$
	Output voltage adjustment range	$V_{oMAX}$	—	—	7.0	V	
P-RUN input block	Input high-level voltage	$V_{iH}$	2.0	—	—	V	
	Input low-level voltage	$V_{iL}$	—	—	0.8	V	
	Input high-level current	$I_{iH}$	—	300	500	$\mu\text{A}$	$V_{iH} = 5.0\text{V}$
	Input low-level current	$I_{iL}$	-5	0	5	$\mu\text{A}$	$V_{iL} = 0.0\text{V}$
NMI output block	High level	$V_{oHN}$	$V_{out} - 0.2$	$V_{out}$	$V_{out} + 0.2$	V	$I_{oHN} = 0\text{mA}$
	Low level	$V_{oLN}$	—	—	0.4	V	$I_{oLN} = 2.0\text{mA}$
	Function start voltage	$V_{STN}$	—	0.7	1.4	V	
$\overline{\text{STBY}}$ output block	High level	$V_{oHS}$	$V_{out} - 0.2$	$V_{out}$	$V_{out} + 0.2$	V	$I_{oHS} = 0\text{mA}$
	Low level	$V_{oLS}$	—	—	0.4	V	$I_{oLS} = 2.0\text{mA}$
	Function start voltage	$V_{STS}$	—	0.7	1.4	V	

Note: Values in parentheses are design reference values.



**Electrical Characteristics** ( $T_a = 25^\circ\text{C}$ ,  $V_{CC} = 12\text{V}$ ,  $V_{out} = 5.0\text{V}$ ,  $R_f = R_R = 180\text{k}\Omega$ ,  $C_f = 3300\text{pF}$ ,  $C_R = 0.1\mu\text{F}$ ,  $R_T = 390\text{k}\Omega$ ,  $C_{RES} = 1500\text{pF}$ ,  $R_{CS} = 0.2\Omega$ ) (cont)

Item		Symbol	Min	Typ	Max	Unit	Test conditions	
$\overline{\text{RES}}$ output block	High level	$V_{OHR}$	$V_{out} - 0.2$	$V_{out}$	$V_{out} + 0.2$	V	$I_{OHR} = 0\text{mA}$	
	Low level	$V_{OLR}$	—	—	0.4	V	$I_{OLR} = 2.0\text{mA}$	
	Function start voltage	$V_{STR}$	—	0.7	1.4	V		
OUTE output block	High level	$V_{OHE}$	$V_{out} - 0.2$	$V_{out}$	$V_{out} + 0.2$	V	$I_{OHE} = 0\text{mA}$	
	Low level	$V_{OLE}$	—	—	0.4	V	$I_{OLE} = 2.0\text{mA}$	
	Function start voltage	$V_{STE}$	—	0.7	1.4	V		
$\overline{\text{RES}}$ function	Power on time	$t_{on}$	25	40	60	ms		
	Clock off time	$t_{off}$	80	130	190	ms		
	Reset pulse high time	$t_{RH}$	40	60	90	ms		
	Reset pulse low time	$t_{RL}$	15	20	30	ms		
LVI function	$\overline{\text{NMI}}$ function detection ( $V_{out}$ detection)	Detection voltage 1	$V_{NMI1}$	4.5	4.63	4.75	V	
		Hysteresis 1	$V_{HYSN1}$	—	50	100	mV	
		Temperature coefficient	$ \delta V_{NMI}/\delta T $	—	100	(400)	ppm/ $^\circ\text{C}$	
	$\overline{\text{NMI}}$ function detection ( $V_{CC}$ detection)	Detection voltage 2	$V_{NMI2}$	5.0	5.4	5.7	V	$R1 = 13\text{k}\Omega$ , $R2 = 390\text{k}\Omega$
		Hysteresis 2	$V_{HYSN2}$	0.5	0.8	1.3	V	$R1 = 13\text{k}\Omega$ , $R2 = 390\text{k}\Omega$
		$\overline{\text{STBY}}$ function	Detection voltage	$V_{STBY}$	2.70	3.00	3.30	V
Hysteresis	$V_{HYSS}$		1.20	1.35	1.50	V		
Temperature coefficient	$ \delta V_{STBY}/\delta T $		—	100	(400)	ppm/ $^\circ\text{C}$		
$\overline{\text{RES}}$ delay time	Disable time	$t_{RES}$	(100)	200	(300)	$\mu\text{s}$		
	Recovery time	$t_r$	(100)	200	(300)	$\mu\text{s}$		

Note: Values in parentheses are design reference values.



System Circuit Examples

- Example of a basic system

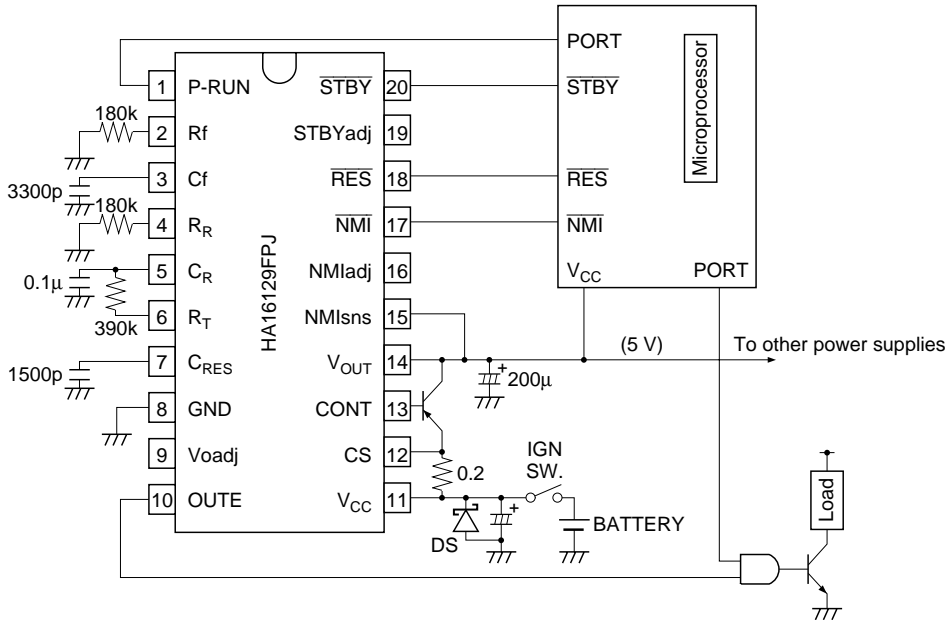

- Example of a system using a backup circuit and a primary voltage monitoring circuit

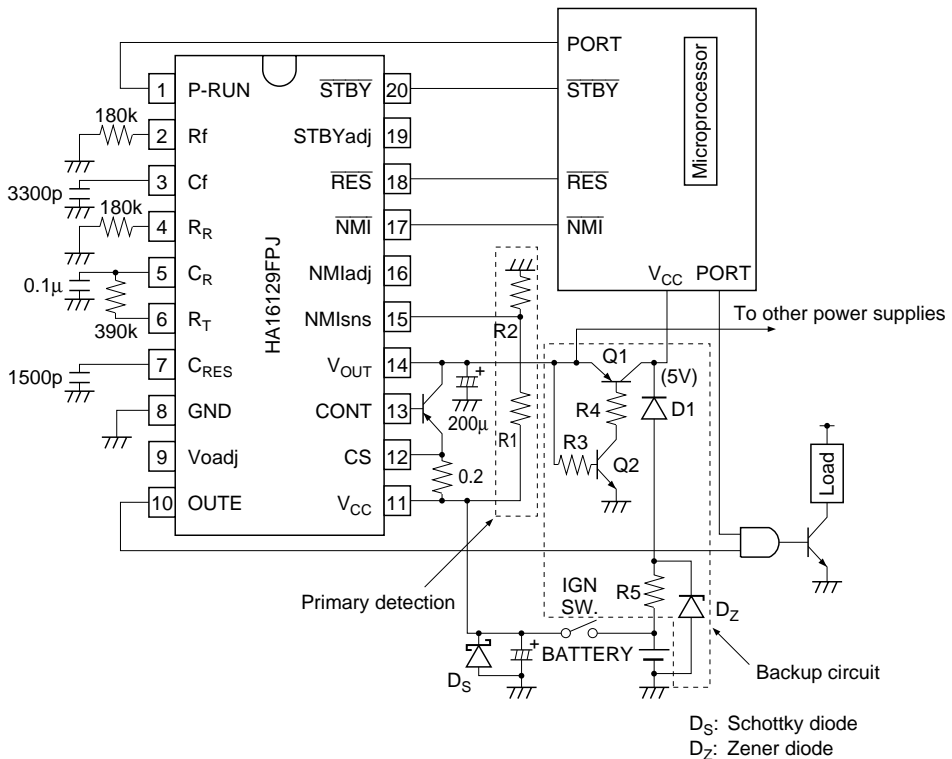

## Operating Waveforms

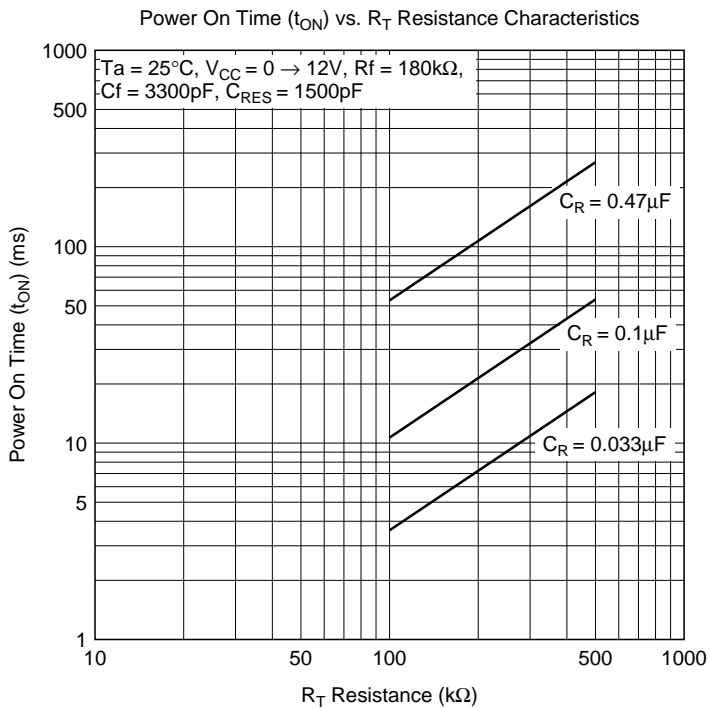
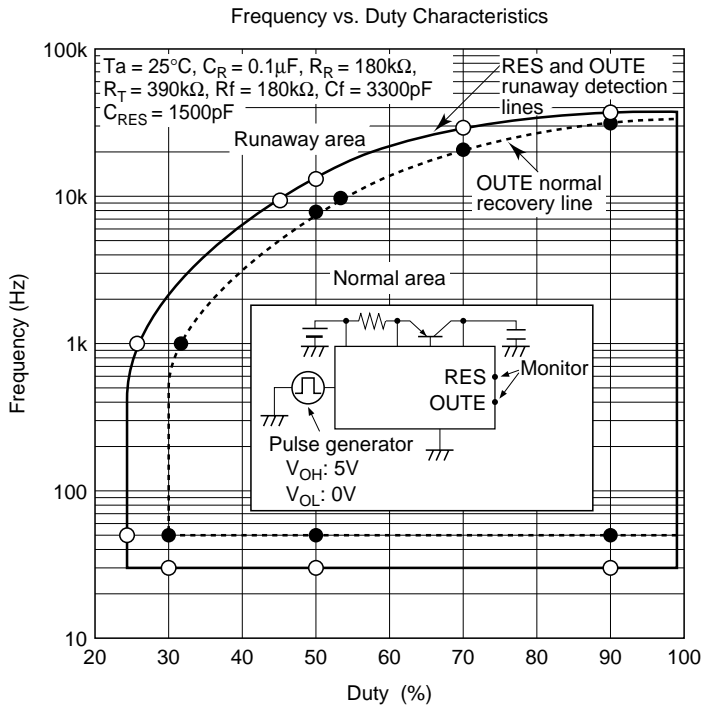

Clock Off Time ( $t_{off}$ ) vs.  $R_R$  Resistance Characteristics

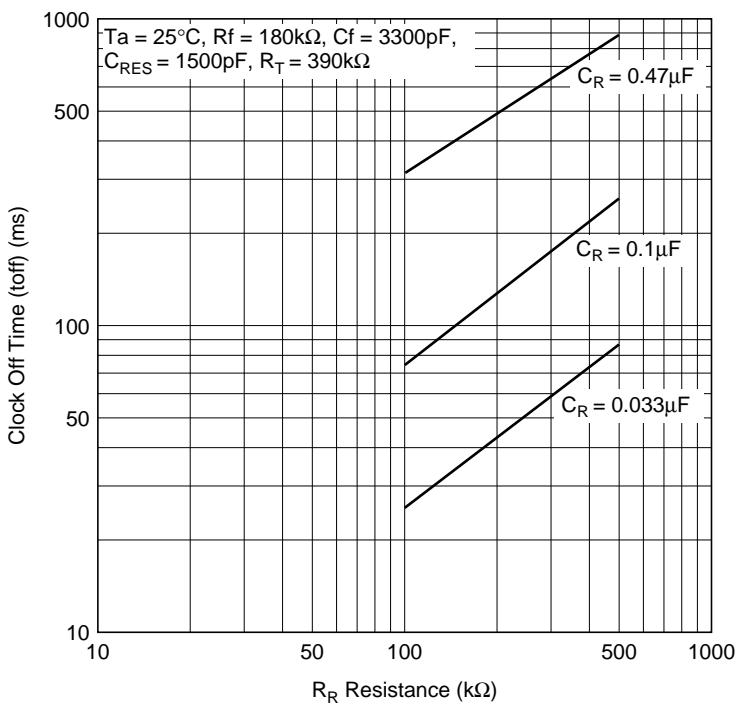

Reset Pulse High Time ( $t_{RH}$ ) vs.  $R_R$  Resistance Characteristics

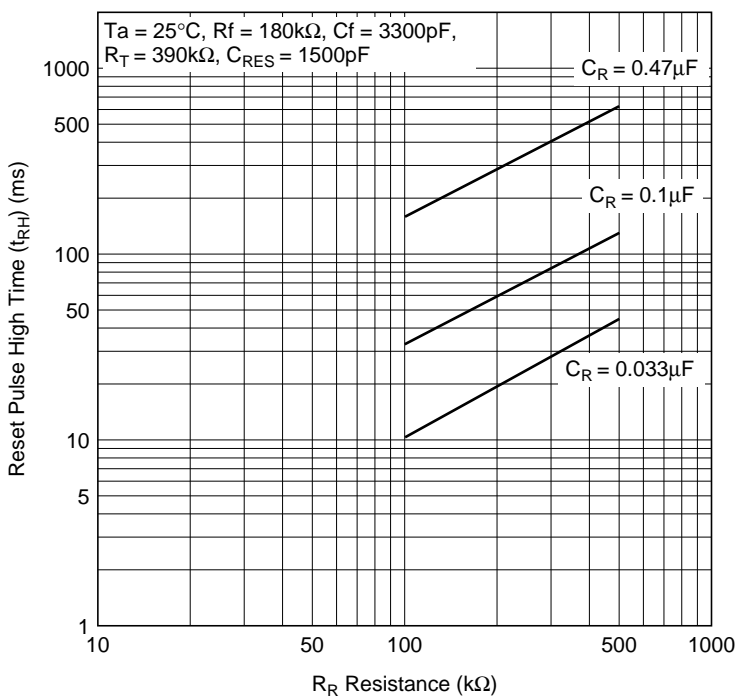

Reset Pulse Low Time ( $t_{RL}$ ) vs.  $R_R$  Resistance Characteristics

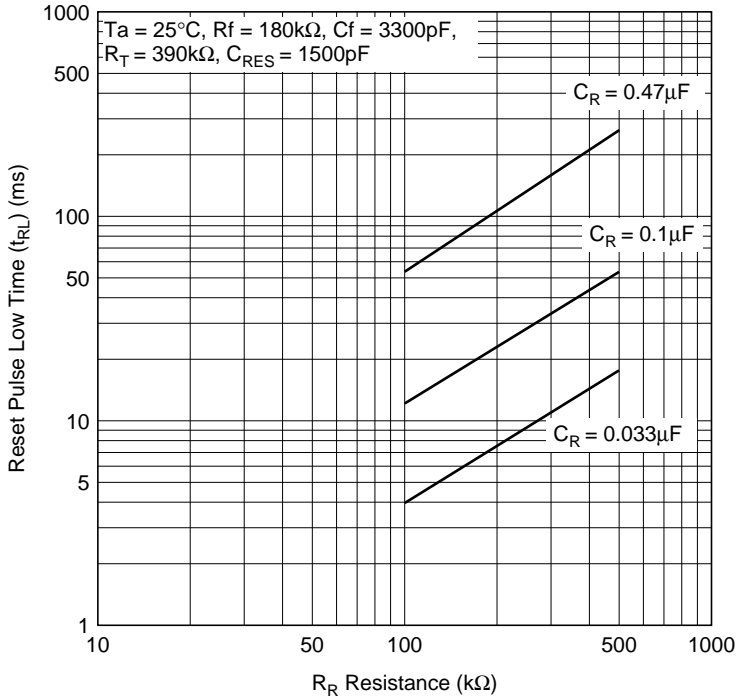

$\overline{RES}$  Delay Time and Recovery Time ( $t_r$ ) vs.  $R_f$  Resistance Characteristics

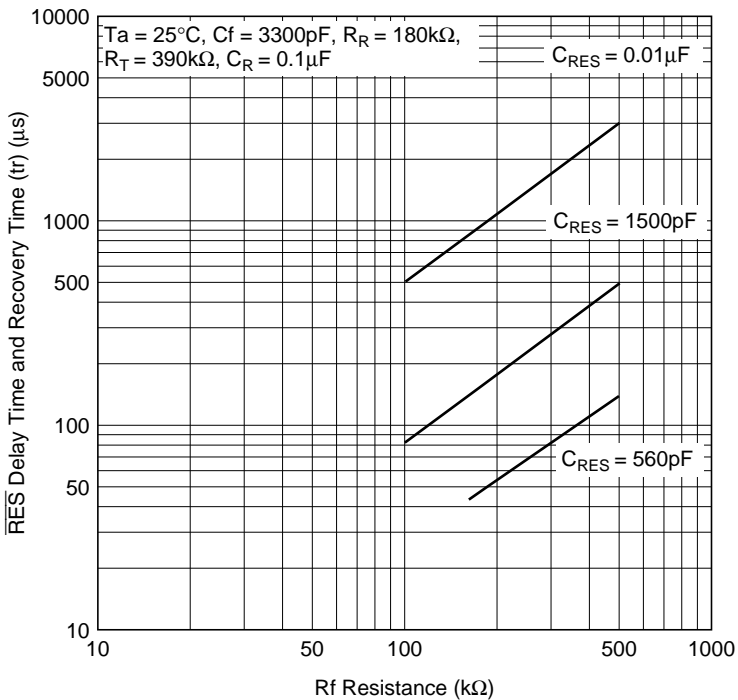

RES Delay Time and Disable Time ( $t_{RES}$ ) vs.  
Rf Resistance Characteristics

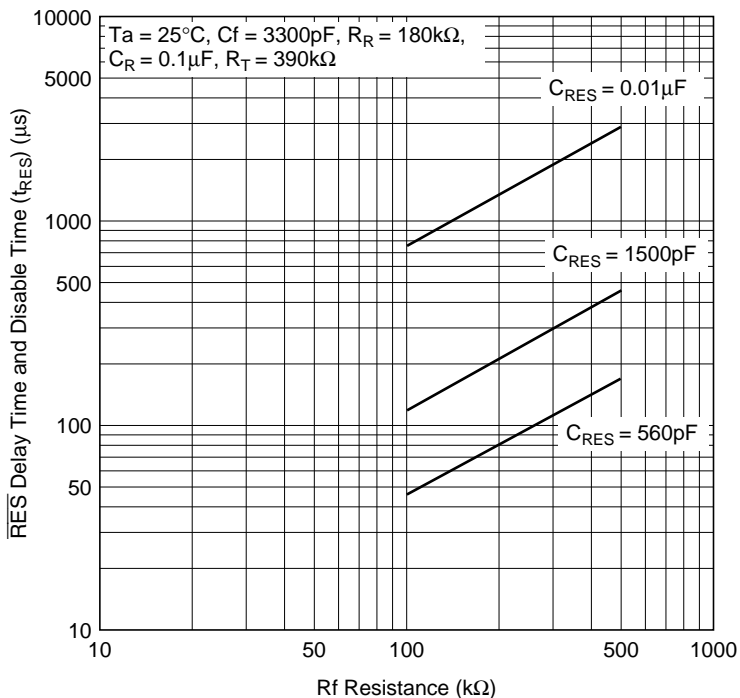

Output Voltage vs.  
Roadj Resistance (to Ground) Characteristics

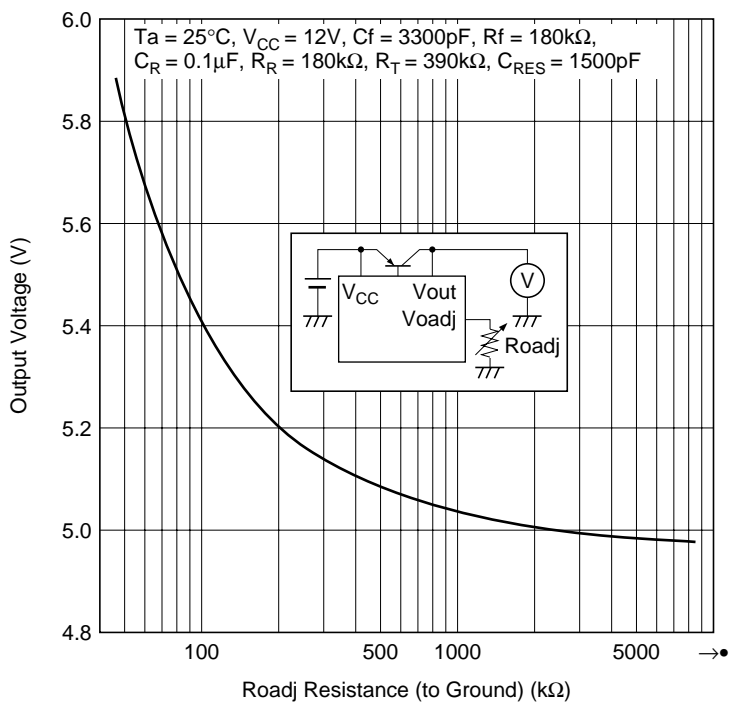

Output Voltage vs.  
Roadj Resistance (to Vout) Characteristics

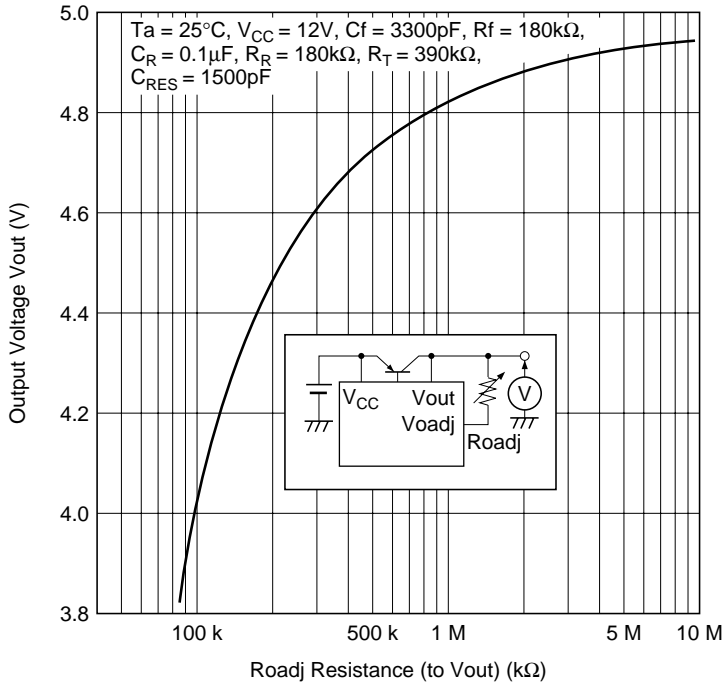

$I_{CONT}$  Current vs. Vout Voltage Characteristics

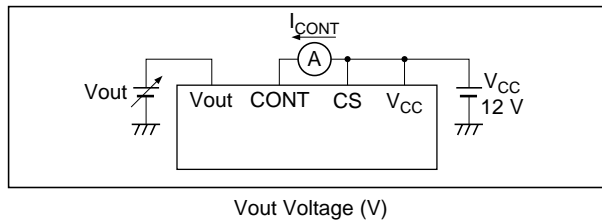
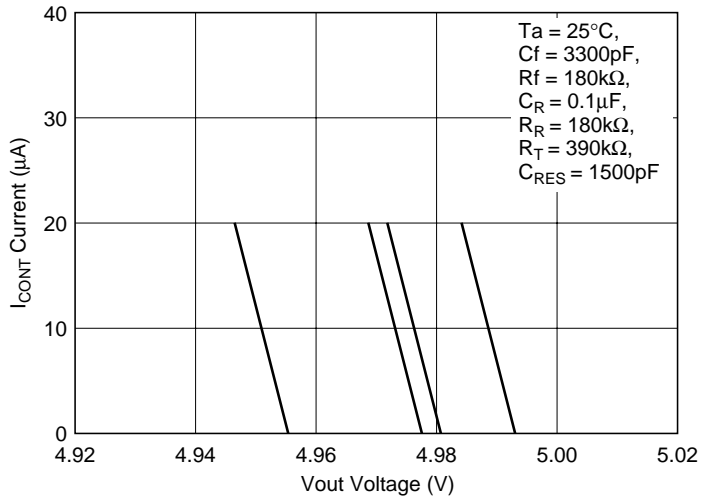



Package Dimensions

Unit: mm

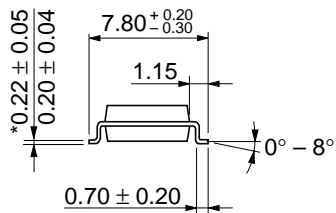
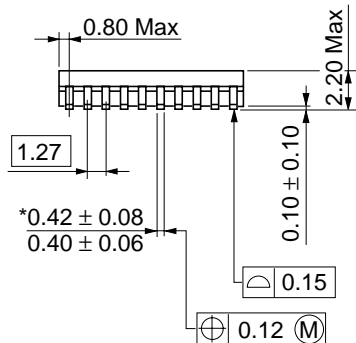
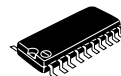
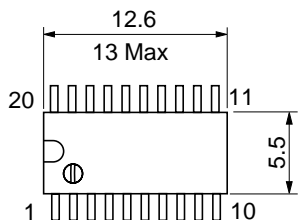

\*Dimension including the plating thickness  
Base material dimension

Hitachi Code	FP-20DA
JEDEC	—
EIAJ	Conforms
Mass (reference value)	0.31 g

## Cautions

1. Hitachi neither warrants nor grants licenses of any rights of Hitachi's or any third party's patent, copyright, trademark, or other intellectual property rights for information contained in this document. Hitachi bears no responsibility for problems that may arise with third party's rights, including intellectual property rights, in connection with use of the information contained in this document.
2. Products and product specifications may be subject to change without notice. Confirm that you have received the latest product standards or specifications before final design, purchase or use.
3. Hitachi makes every attempt to ensure that its products are of high quality and reliability. However, contact Hitachi's sales office before using the product in an application that demands especially high quality and reliability or where its failure or malfunction may directly threaten human life or cause risk of bodily injury, such as aerospace, aeronautics, nuclear power, combustion control, transportation, traffic, safety equipment or medical equipment for life support.
4. Design your application so that the product is used within the ranges guaranteed by Hitachi particularly for maximum rating, operating supply voltage range, heat radiation characteristics, installation conditions and other characteristics. Hitachi bears no responsibility for failure or damage when used beyond the guaranteed ranges. Even within the guaranteed ranges, consider normally foreseeable failure rates or failure modes in semiconductor devices and employ systemic measures such as fail-safes, so that the equipment incorporating Hitachi product does not cause bodily injury, fire or other consequential damage due to operation of the Hitachi product.
5. This product is not designed to be radiation resistant.
6. No one is permitted to reproduce or duplicate, in any form, the whole or part of this document without written approval from Hitachi.
7. Contact Hitachi's sales office for any questions regarding this document or Hitachi semiconductor products.

# HITACHI

## Hitachi, Ltd.

Semiconductor & Integrated Circuits.

Nippon Bldg., 2-6-2, Ohte-machi, Chiyoda-ku, Tokyo 100-0004, Japan

Tel: Tokyo (03) 3270-2111 Fax: (03) 3270-5109

URL	NorthAmerica	: <a href="http://semiconductor.hitachi.com/">http://semiconductor.hitachi.com/</a>
	Europe	: <a href="http://www.hitachi-eu.com/hel/ecg">http://www.hitachi-eu.com/hel/ecg</a>
	Asia	: <a href="http://sicapac.hitachi-asia.com">http://sicapac.hitachi-asia.com</a>
	Japan	: <a href="http://www.hitachi.co.jp/Sicd/indx.htm">http://www.hitachi.co.jp/Sicd/indx.htm</a>

### For further information write to:

Hitachi Semiconductor  
(America) Inc.  
179 East Tasman Drive,  
San Jose, CA 95134  
Tel: <1> (408) 433-1990  
Fax: <1> (408) 433-0223

Hitachi Europe Ltd.  
Electronic Components Group.  
Whitebrook Park  
Lower Cookham Road  
Maidenhead  
Berkshire SL6 8YA, United Kingdom  
Tel: <44> (1628) 585000  
Fax: <44> (1628) 585200

Hitachi Europe GmbH  
Electronic Components Group  
Dornacher StraÙe 3  
D-85622 Feldkirchen, Munich  
Germany  
Tel: <49> (89) 9 9180-0  
Fax: <49> (89) 9 29 30 00

Hitachi Asia Ltd.  
Hitachi Tower  
16 Collyer Quay #20-00,  
Singapore 049318  
Tel: <65>-538-6533/538-8577  
Fax: <65>-538-6933/538-3877  
URL: <http://www.hitachi.com.sg>

Hitachi Asia Ltd.  
(Taipei Branch Office)  
4/F, No. 167, Tun Hwa North Road,  
Hung-Kuo Building,  
Taipei (105), Taiwan  
Tel: <886>-(2)-2718-3666  
Fax: <886>-(2)-2718-8180  
Telex: 23222 HAS-TP  
URL: <http://www.hitachi.com.tw>

Hitachi Asia (Hong Kong) Ltd.  
Group III (Electronic Components)  
7/F., North Tower,  
World Finance Centre,  
Harbour City, Canton Road  
Tsim Sha Tsui, Kowloon,  
Hong Kong  
Tel: <852>-(2)-735-9218  
Fax: <852>-(2)-730-0281  
URL: <http://semiconductor.hitachi.com.hk>

Copyright © Hitachi, Ltd., 2001. All rights reserved. Printed in Japan.

Colophon 3.0