

FEATURES

- Double Side Cooling
- High Surge Capability

APPLICATIONS

- High Power Drives
- High Voltage Power Supplies
- Static Switches

VOLTAGE RATINGS

Part and Ordering Number	Repetitive Peak Voltages V_{DRM} and V_{RRM} V	Conditions
DCR3030V42	4200	$T_{vj} = -40^{\circ}\text{C}$ to 125°C , $I_{DRM} = I_{RRM} = 200\text{mA}$, $V_{DRM}, V_{RRM} t_p = 10\text{ms}$, $V_{DSM} \& V_{RSM} =$ $V_{DRM} \& V_{RRM} + 100\text{V}$ respectively
DCR3030V40	4000	
DCR3030V35	3500	
DCR3030V30	3000	

Lower voltage grades available.

ORDERING INFORMATION

When ordering, select the required part number shown in the Voltage Ratings selection table.

For example:

DCR3030V42

Note: Please use the complete part number when ordering and quote this number in any future correspondence relating to your order.

KEY PARAMETERS

V_{DRM}	4200V
$I_{T(AV)}$	3030A
I_{TSM}	40600A
dV/dt^*	1500V/μs
dI/dt	400A/μs

* Higher dV/dt selections available

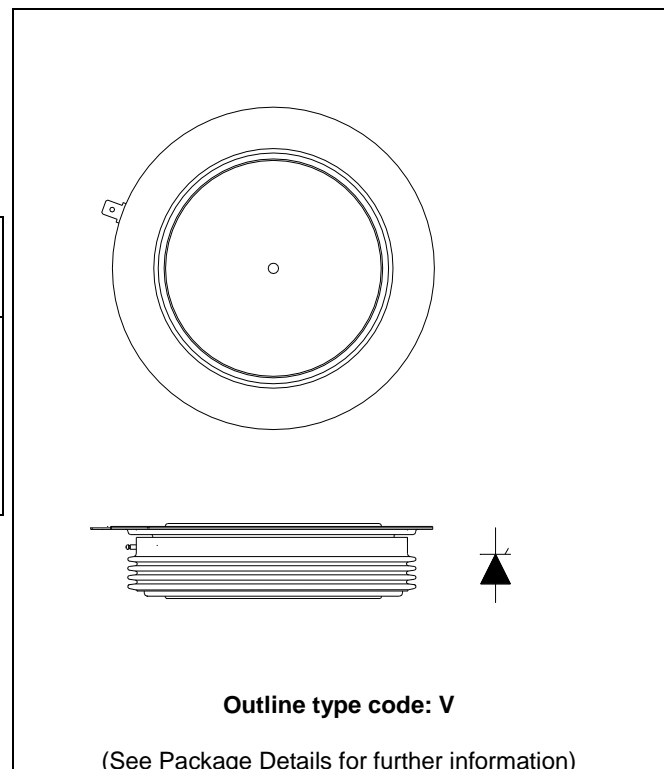

Fig. 1 Package outline

CURRENT RATINGS
 $T_{case} = 60^{\circ}\text{C}$ unless stated otherwise

Symbol	Parameter	Test Conditions	Max.	Units
Double Side Cooled				
$I_{T(AV)}$	Mean on-state current	Half wave resistive load	3030	A
$I_{T(RMS)}$	RMS value	-	4760	A
I_T	Continuous (direct) on-state current	-	4550	A

SURGE RATINGS

Symbol	Parameter	Test Conditions	Max.	Units
I_{TSM}	Surge (non-repetitive) on-state current	10ms half sine, $T_{case} = 125^{\circ}\text{C}$	40.6	kA
I^2t	I^2t for fusing	$V_R = 0$	8.24	MA^2s

THERMAL AND MECHANICAL RATINGS

Symbol	Parameter	Test Conditions	Min.	Max.	Units	
$R_{th(j-c)}$	Thermal resistance – junction to case	Double side cooled	DC	-	0.00746	$^{\circ}\text{C/W}$
		Single side cooled	Anode DC	-	0.0130	$^{\circ}\text{C/W}$
			Cathode DC	-	0.0178	$^{\circ}\text{C/W}$
$R_{th(c-h)}$	Thermal resistance – case to heatsink	Clamping force 54kN (with mounting compound)	Double side	-	0.002	$^{\circ}\text{C/W}$
			Single side	-	0.004	$^{\circ}\text{C/W}$
T_{vj}	Virtual junction temperature	(blocking)	-	125	$^{\circ}\text{C}$	
T_{stg}	Storage temperature range		-55	125	$^{\circ}\text{C}$	
F_m	Clamping force		48.0	59.0	kN	

DYNAMIC CHARACTERISTICS

Symbol	Parameter	Test Conditions	Min.	Max.	Units	
I_{RRM}/I_{DRM}	Peak reverse and off-state current	At V_{RRM}/V_{DRM} , $T_{case} = 125^{\circ}C$	-	200	mA	
dV/dt	Max. linear rate of rise of off-state voltage	To 67% V_{DRM} , $T_j = 125^{\circ}C$, gate open	-	1500	V/ μs	
di/dt	Rate of rise of on-state current	From 67% V_{DRM} to $2x I_{T(AV)}$	Repetitive 50Hz	-	200	A/ μs
		Gate source 30V, 10 Ω , $t_r < 0.5\mu s$, $T_j = 125^{\circ}C$	Non-repetitive	-	400	A/ μs
$V_{T(TO)}$	Threshold voltage – Low level	200A to 1700A at $T_{case} = 125^{\circ}C$	-	0.82	V	
	Threshold voltage – High level	1700A to 7000A at $T_{case} = 125^{\circ}C$	-	0.98	V	
r_T	On-state slope resistance – Low level	200A to 1700A at $T_{case} = 125^{\circ}C$	-	0.292	m Ω	
	On-state slope resistance – High level	1700A to 7000A at $T_{case} = 125^{\circ}C$	-	0.198	m Ω	
t_{gd}	Delay time	$V_D = 67\% V_{DRM}$, gate source 30V, 10 Ω $t_r = 0.5\mu s$, $T_j = 25^{\circ}C$	TBD	TBD	μs	
t_q	Turn-off time	$T_j = 125^{\circ}C$, $V_R = 200V$, $di/dt = 1A/\mu s$, $dV_{DR}/dt = 20V/\mu s$ linear	250	500	μs	
Q_S	Stored charge	$T_j = 125^{\circ}C$, $di/dt = 1A/\mu s$, $V_{Rpk} = 3000V$, $V_{RM} = 1700V$	1600	3500	μC	
I_L	Latching current	$T_j = 25^{\circ}C$, $V_D = 5V$	-	3	A	
I_H	Holding current	$T_j = 25^{\circ}C$, $R_{G-K} = \infty$, $I_{TM} = 500A$, $I_T = 5A$	-	300	mA	

GATE TRIGGER CHARACTERISTICS AND RATINGS

Symbol	Parameter	Test Conditions	Max.	Units
V_{GT}	Gate trigger voltage	$V_{DRM} = 5V, T_{case} = 25^{\circ}C$	1.5	V
V_{GD}	Gate non-trigger voltage	At $V_{DRM}, T_{case} = 125^{\circ}C$	TBD	V
I_{GT}	Gate trigger current	$V_{DRM} = 5V, T_{case} = 25^{\circ}C$	250	mA
I_{GD}	Gate non-trigger current	$V_{DRM} = 5V, T_{case} = 25^{\circ}C$	TBD	mA

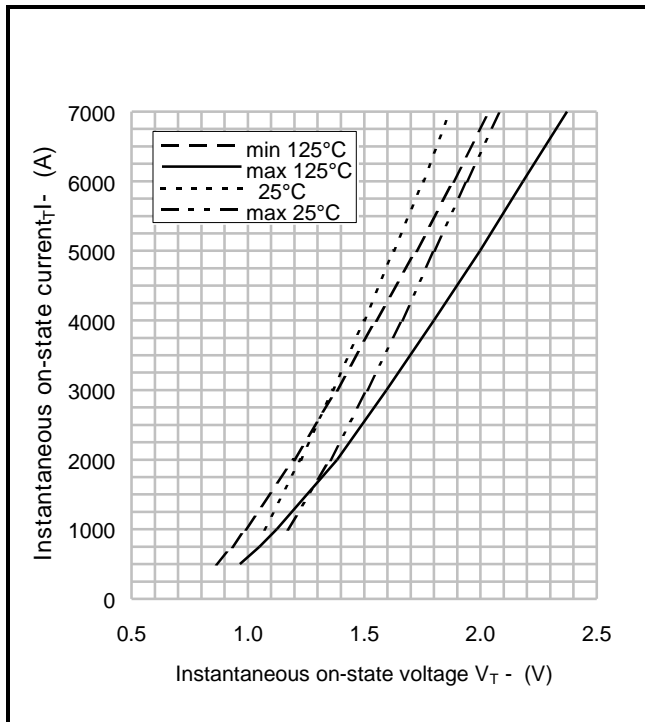
CURVES

Fig.2 Maximum & minimum on-state characteristics
 V_{TM} EQUATION

$$V_{TM} = A + B \ln(I_T) + C \cdot I_T + D \cdot \sqrt{I_T}$$

Where $A = 0.866995$
 $B = -0.042053$
 $C = 0.000100$
 $D = 0.014062$

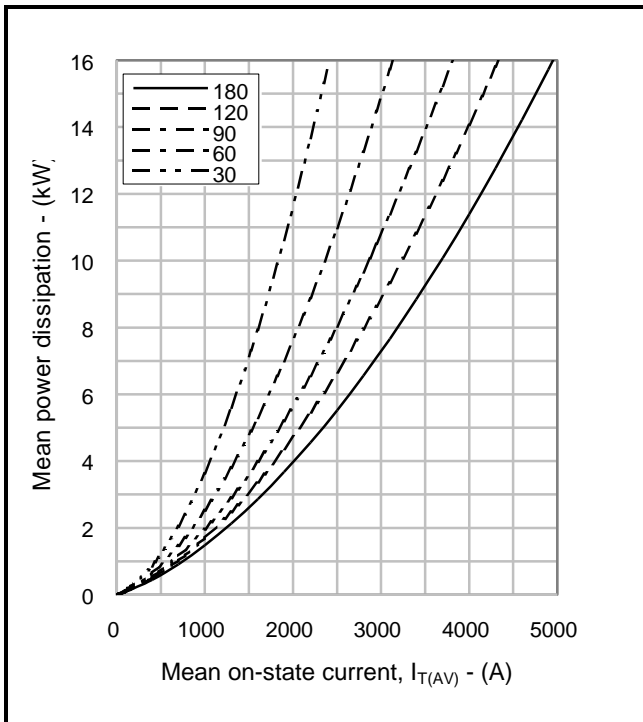
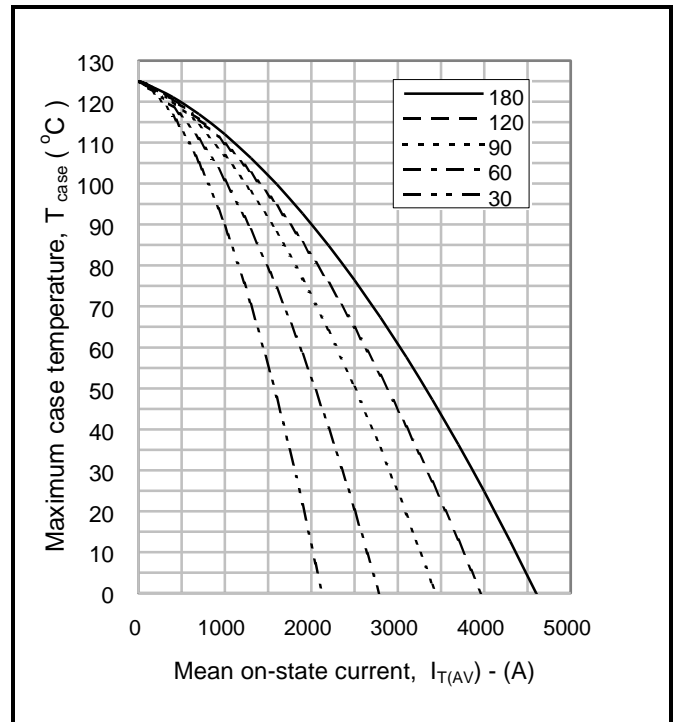
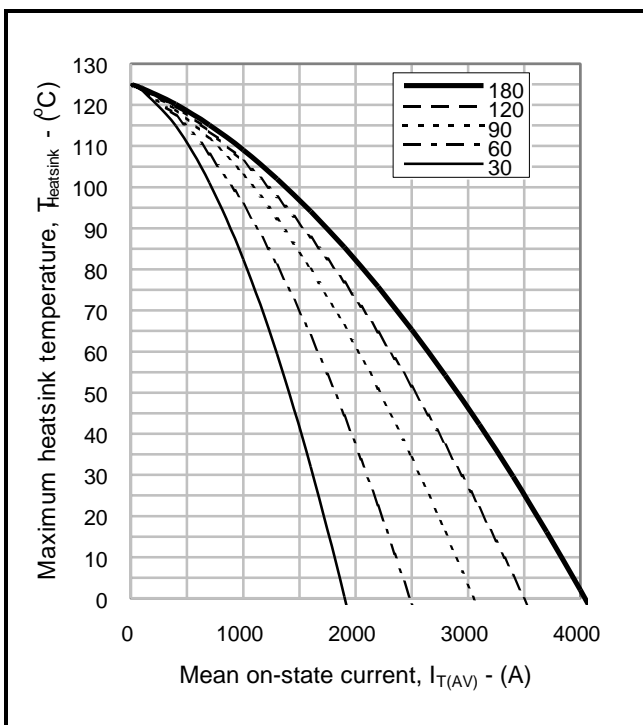
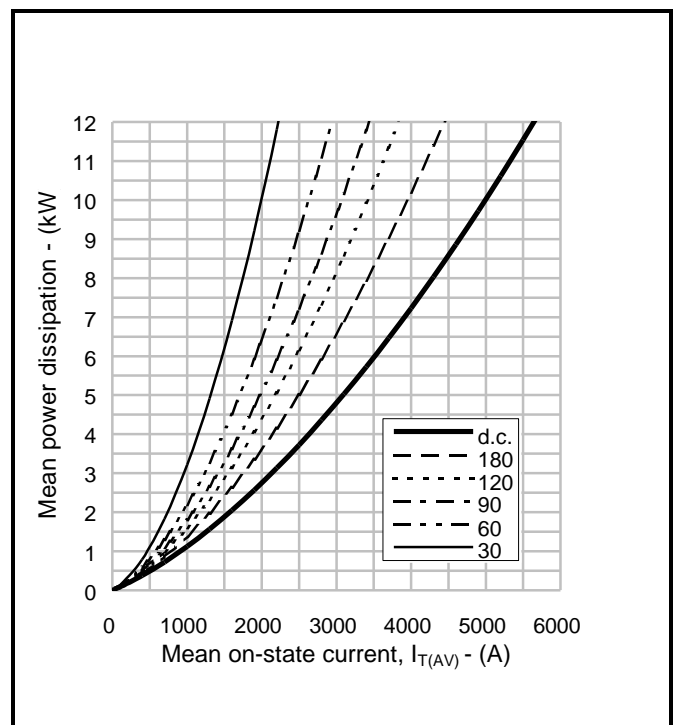
these values are valid for $T_j = 125^{\circ}C$ for I_T 500A to 10000A

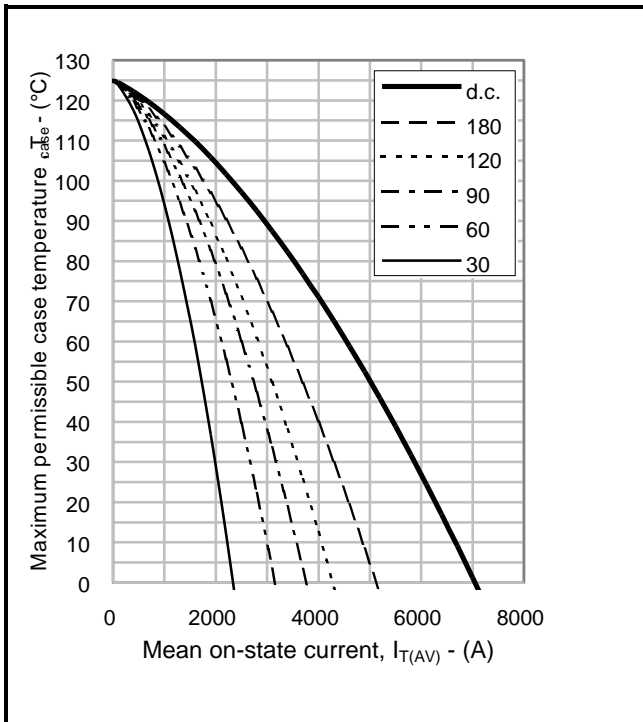
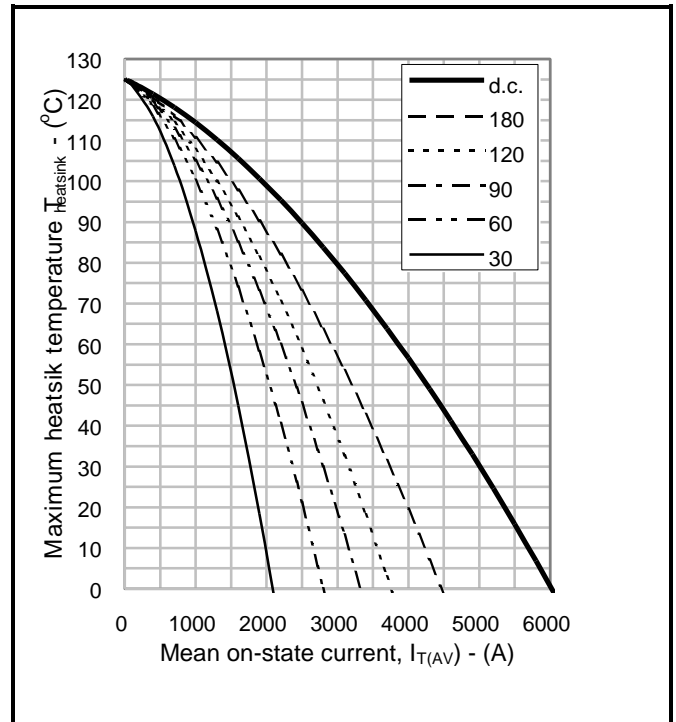
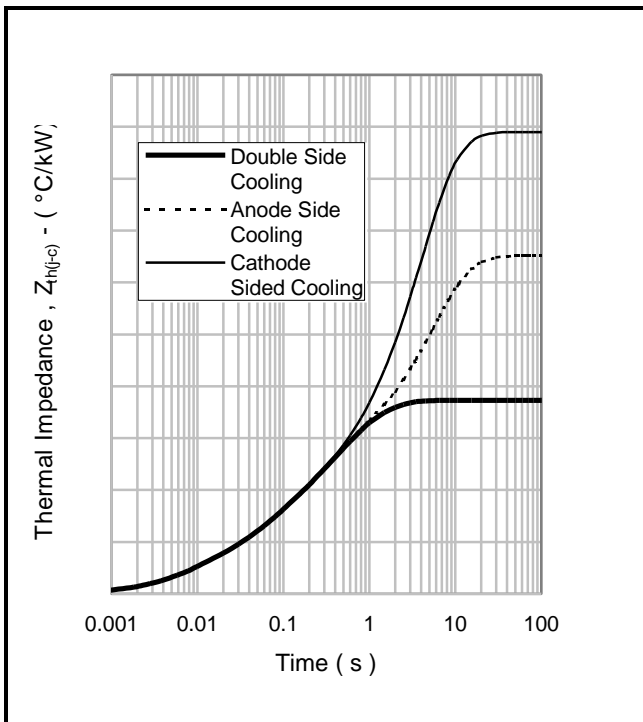
Fig.3 On-state power dissipation – sine wave

Fig.4 Maximum permissible case temperature, double side cooled – sine wave

Fig.5 Maximum permissible heatsink temperature, double side cooled – sine wave

Fig.6 On-state power dissipation – rectangular wave

Fig.7 Maximum permissible case temperature, double side cooled – rectangular wave

Fig.8 Maximum permissible heatsink temperature, double side cooled – rectangular wave

Fig.9 Maximum (limit) transient thermal impedance – junction to case (°C/kW)

		1	2	3	4
Double side cooled	R_{θ} (°C/kW)	0.9206	1.8299	3.4022	1.3044
	T_1 (s)	0.0076807	0.0579454	0.4078613	1.2085
Anode side cooled	R_{θ} (°C/kW)	0.9032	1.6719	3.0101	7.4269
	T_1 (s)	0.0075871	0.0536531	0.3144537	5.624
Cathode side cooled	R_{θ} (°C/kW)	0.9478	2.0661	1.6884	13.0847
	T_1 (s)	0.0078442	0.0645541	0.3894389	4.1447

$$Z_{th} = \sum [R_i \times (1 - \exp. (-t/t_i))] \quad [1]$$

$\Delta R_{th(j-c)}$ Conduction

Tables show the increments of thermal resistance $R_{th(j-c)}$ when the device operates at conduction angles other than d.c.

Double side cooling			Anode Side Cooling			Cathode Sided Cooling		
α°	$\Delta Z_{th} (z)$		α°	$\Delta Z_{th} (z)$		α°	$\Delta Z_{th} (z)$	
	sine.	rect.		sine.	rect.		sine.	rect.
180	1.34	0.88	180	1.34	0.88	180	1.33	0.88
120	1.57	1.30	120	1.57	1.30	120	1.57	1.29
90	1.83	1.54	90	1.84	1.54	90	1.83	1.53
60	2.08	1.81	60	2.08	1.81	60	2.07	1.80
30	2.27	2.11	30	2.28	2.11	30	2.26	2.10
15	2.36	2.28	15	2.37	2.28	15	2.35	2.26

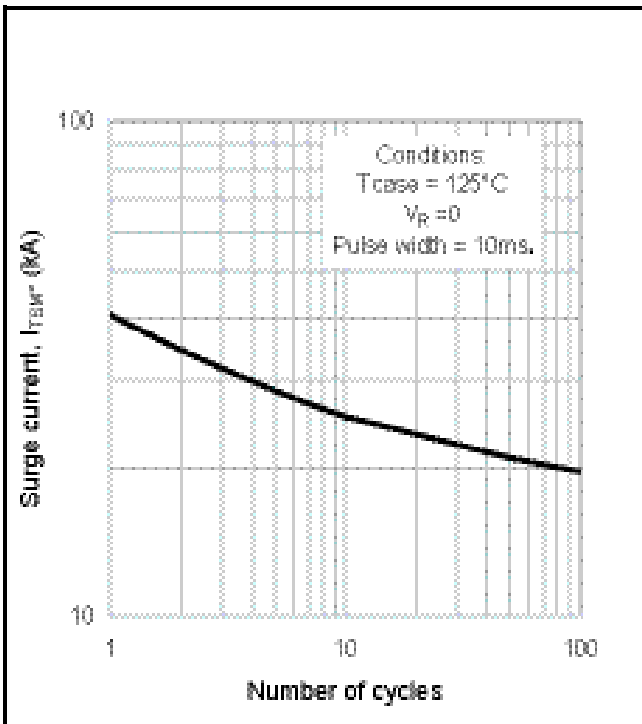
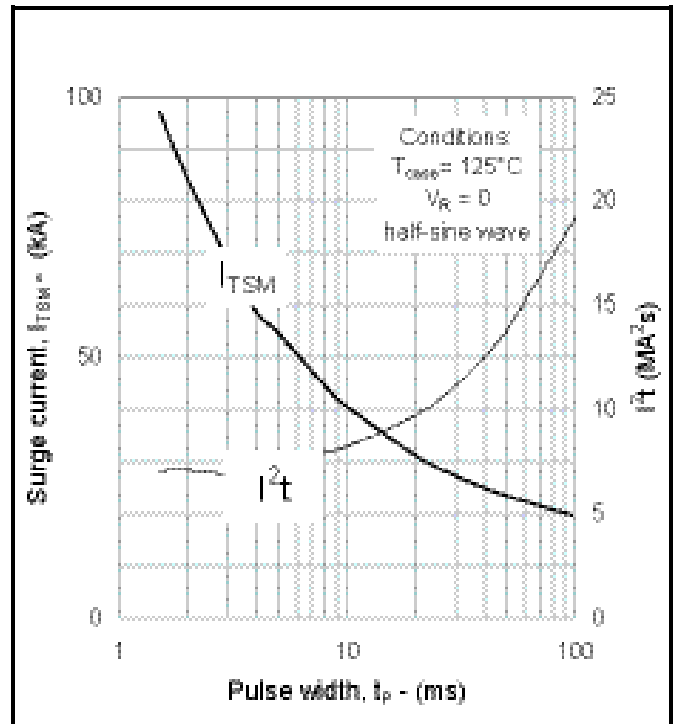
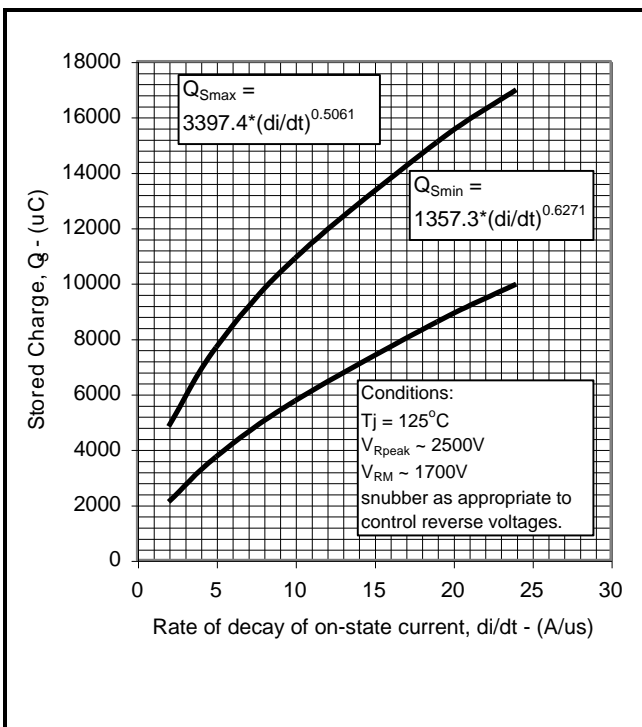
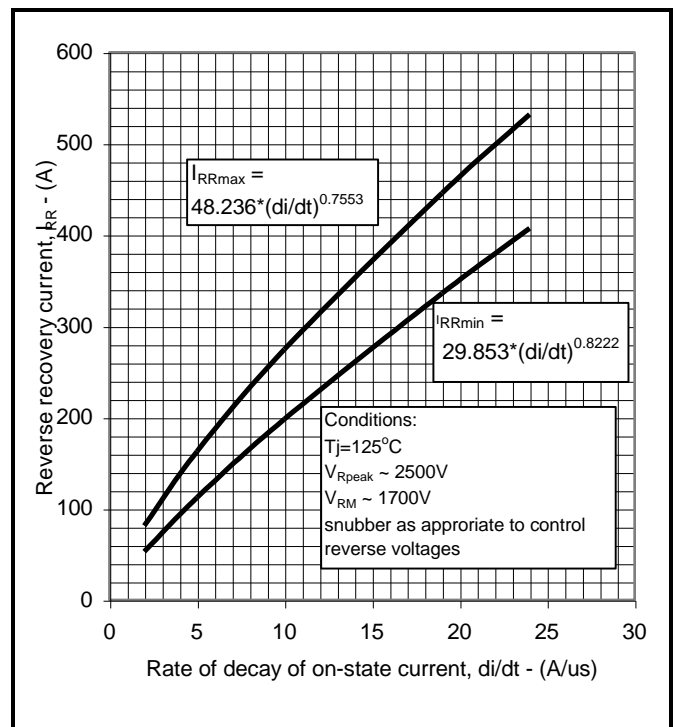
Fig.10 Multi-cycle surge current

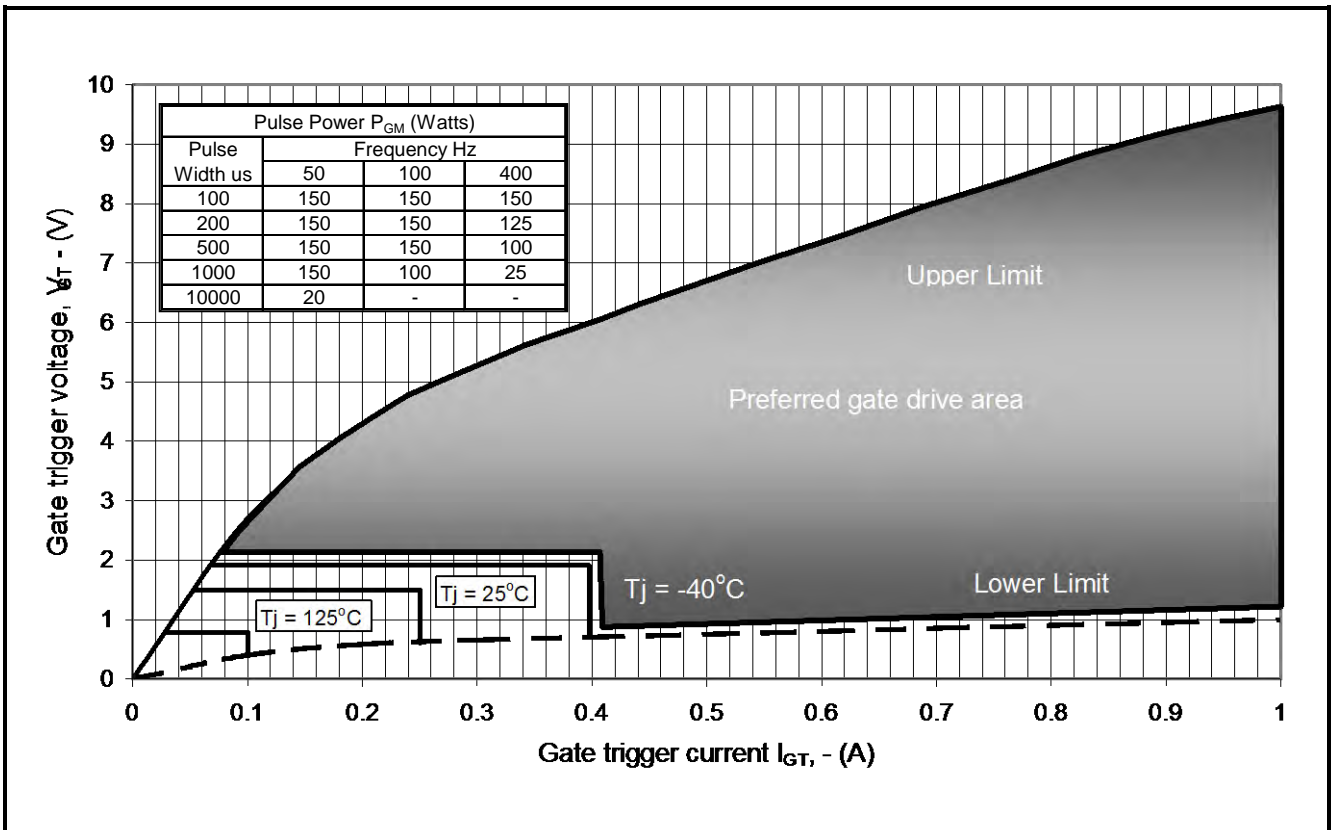
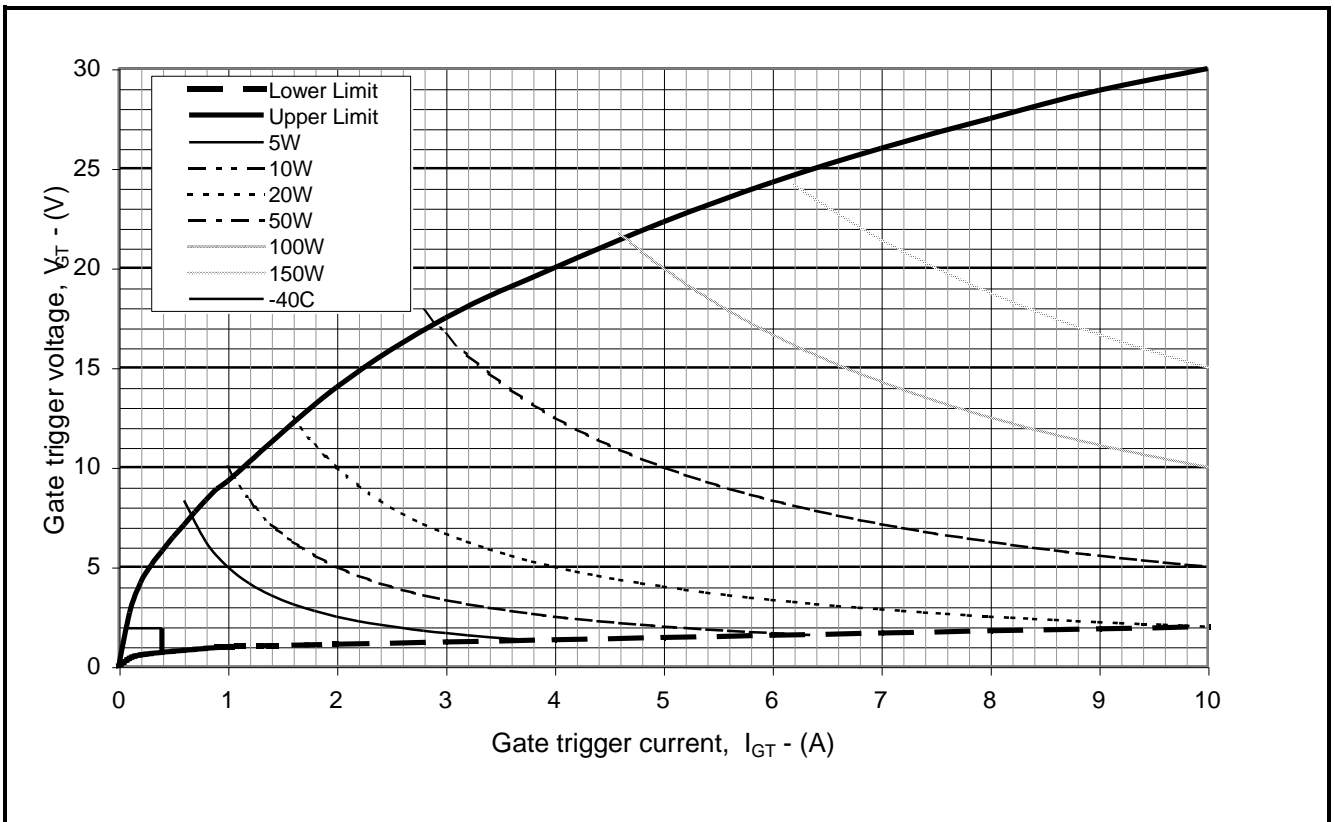
Fig.11 Single-cycle surge current

Fig. 12 Stored Charge

Fig. 13 Reverse Recovery Current

Fig14 Gate Characteristics

Fig. 15 Gate characteristics

PACKAGE DETAILS

For further package information, please contact Customer Services. All dimensions in mm, unless stated otherwise. DO NOT SCALE.

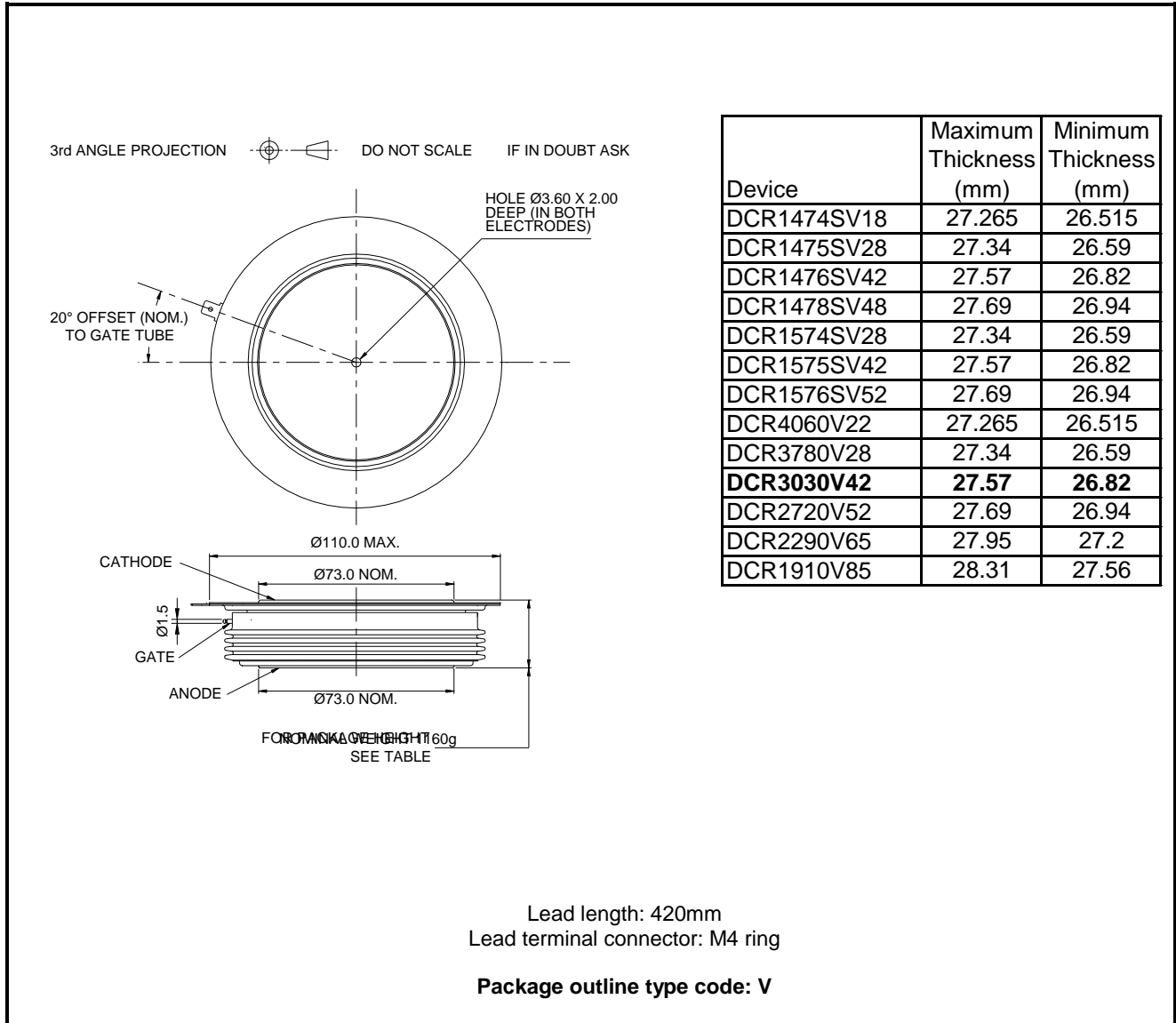

Fig.16 Package outline