

Surface mount switching diode

**BAV23**

**FEATURES**

- Continuous reverse voltage:max.75V
- Switching speed:50ns.
- Repetitive peak reverse voltage:max.250V
- Repetitive peak forward current:max.625mA

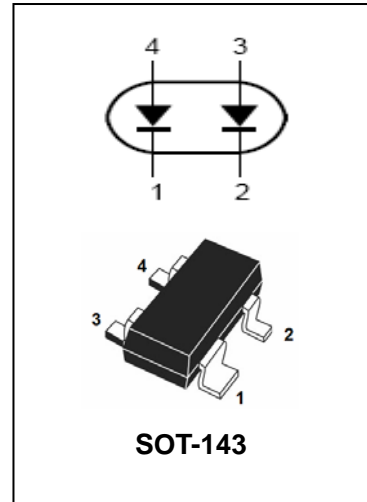

**APPLICATIONS**

- General application.

**ORDERING INFORMATION**

Type No.	Marking	Package Code
BAV23	L30	SOT-143

**MAXIMUM RATING @ Ta=25 °C unless otherwise specified**

Characteristic	Symbol	Limits	Unit
Repetitive Peak Reverse Voltage	$V_{RRM}$	250	V
Continuous Reverse Voltage	$V_R$	200	V
Continuous forward current	$I_F$	225 125	mA
Repetitive peak forward current	$I_{FRM}$	625	mA
Surge current	$I_{FSM}$	9 3 1.7	A
Power Dissipation	$P_d$	250	mW
Operating Junction Temperature Range	$T_j$	150	°C
Storage Temperature Range	$T_{STG}$	-65 to +150	°C

**ELECTRICAL CHARACTERISTICS @ Ta=25°C unless otherwise specified**

Characteristic	Symbol	Min	Typ	MAX	UNIT	Test Condition
Reverse Breakdown Voltage	$V_{(BR)R}$	200	-	-	V	$I_R = 100\mu A$
Forward Voltage	$V_F$	-	-	1.0 1.25	V	$I_F = 100mA$ $I_F = 200mA$
Forward Voltage series connection	$V_F$	-	-	2.0 2.5	V	$I_F = 100mA$ $I_F = 200mA$
Reverse Leakage Current	$I_R$	-	-	100 100	nA $\mu A$	$V_R = 200V$ $V_R = 200V, T_j = 150^\circ C$
Reverse Leakage Current series connection	$I_R$	-	-	100 100	nA $\mu A$	$V_R = 400V$ $V_R = 400V, T_j = 150^\circ C$
Diodes Capacitance series connection	$C_d$	-	-	5 2.5	pF	$V_R = 0V, f = 1.0MHz$
Reverse Recovery Time	$t_{rr}$	-	-	50	ns	$I_F = I_R = 10mA, I_{rr} = 0.1 * I_R$

**TYPICAL CHARACTERISTICS @ Ta=25°C unless otherwise specified**

Fig.2 Maximum permissible continuous forward current as a function of ambient temperature.



(1)  $T_j = 150^\circ C$ ; typical values.  
(2)  $T_j = 25^\circ C$ ; typical values.  
(3)  $T_j = 25^\circ C$ ; maximum values.

Fig.3 Forward current as a function of forward voltage.

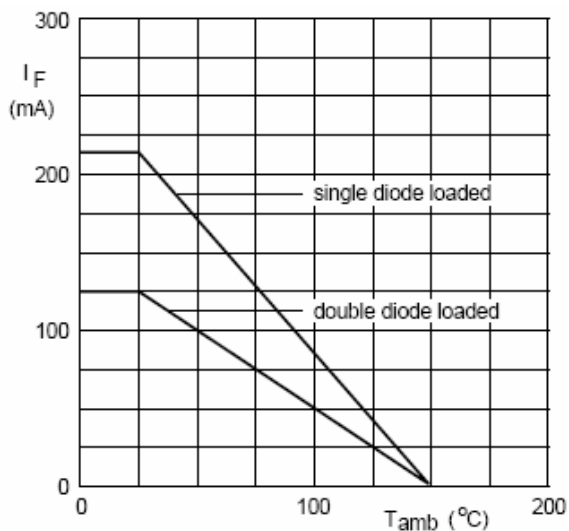
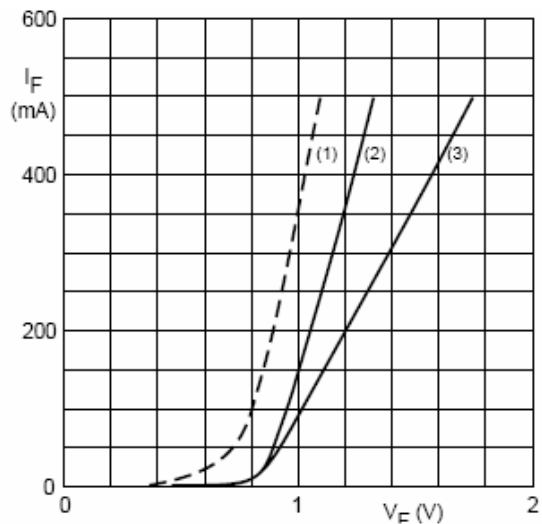
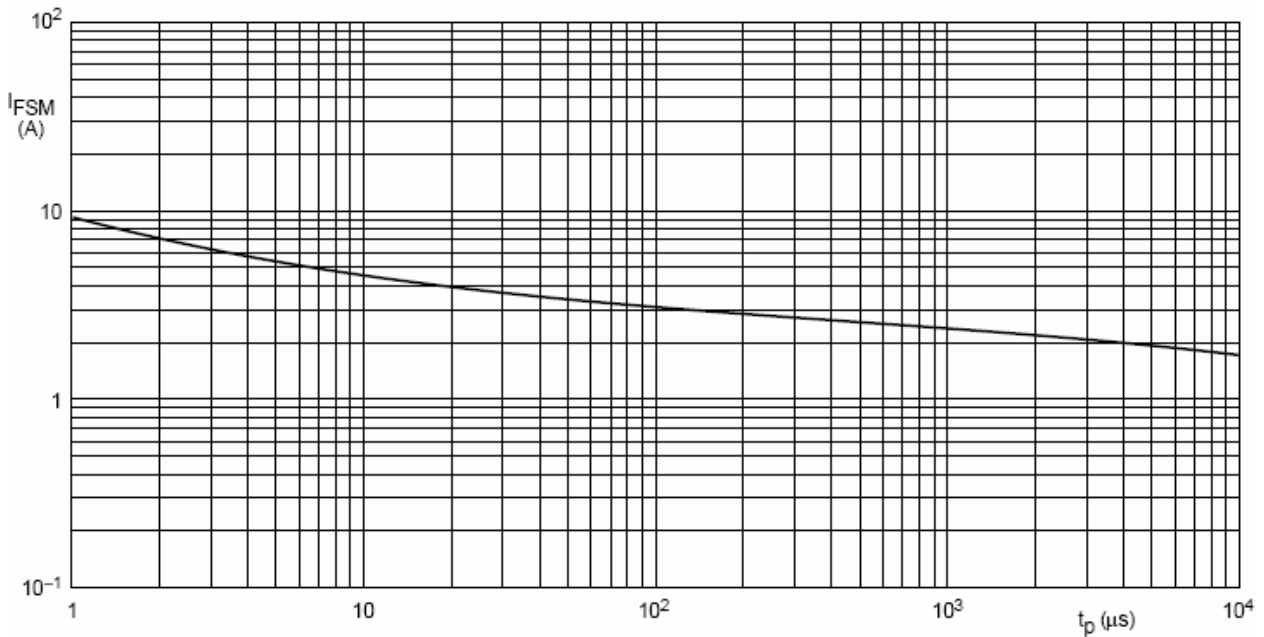
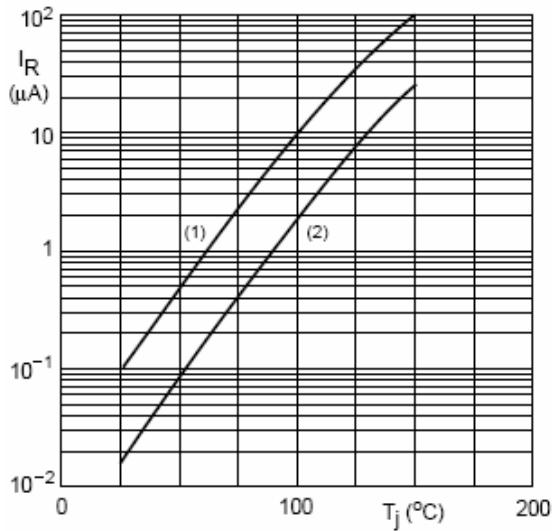
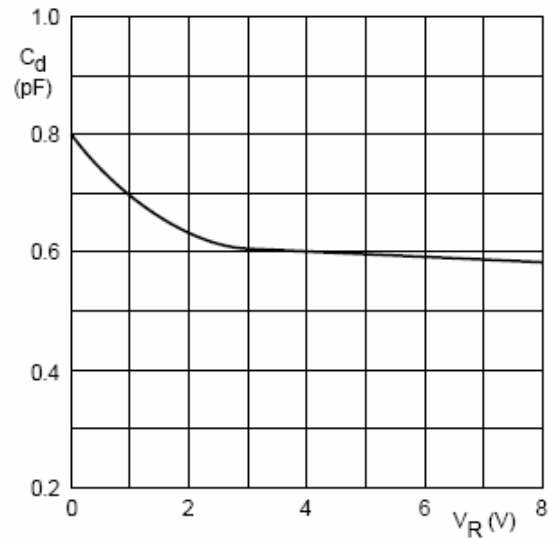

Fig.4 Maximum permissible non-repetitive peak forward current as a function of pulse duration.



- (1)  $V_R = 200\text{ V}$ ; maximum values.  
 (2)  $V_R = 200\text{ V}$ ; typical values.

Fig.5 Reverse current as a function of junction temperature.



$f = 1\text{ MHz}$ ;  $T_j = 25\text{ }^{\circ}\text{C}$ .

Fig.6 Diode capacitance as a function of reverse voltage; typical values.

**PACKAGE OUTLINE**

Plastic surface mounted package

SOT-143

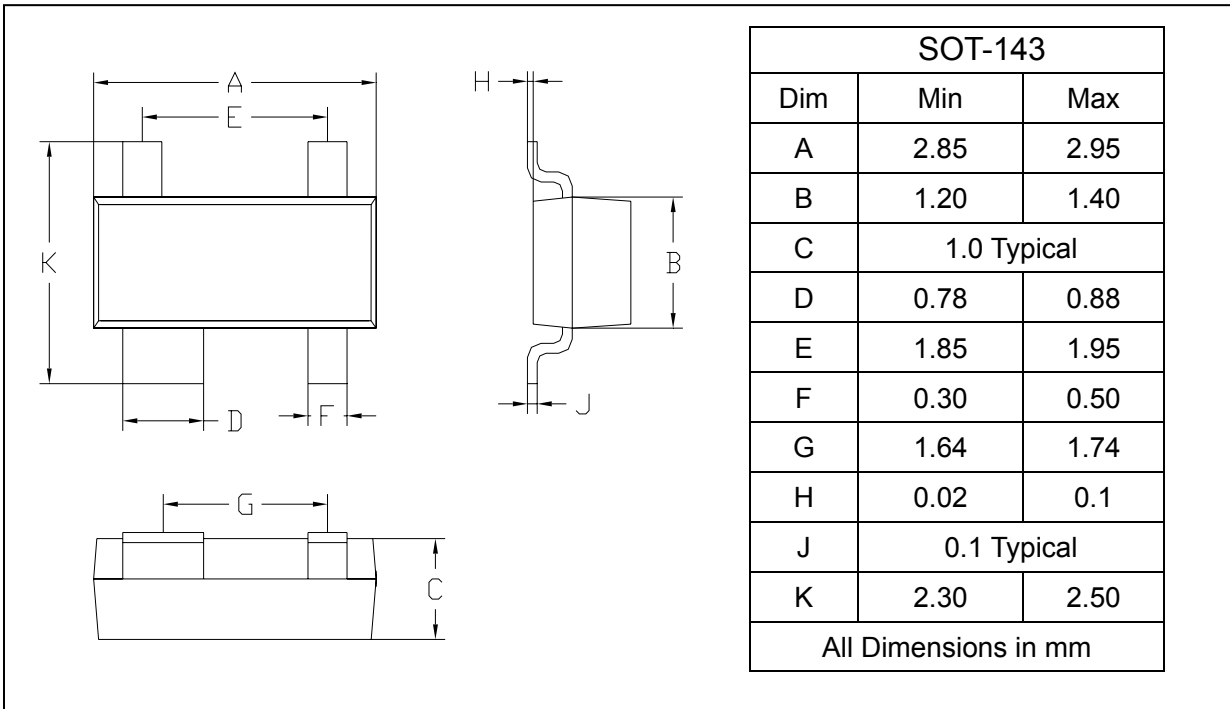
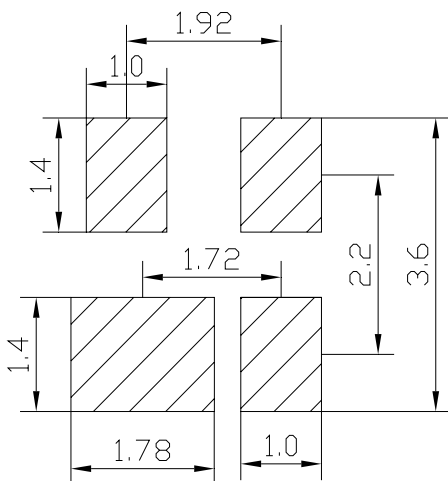
**SOLDERING FOOTPRINT**

Unit : mm

**PACKAGE INFORMATION**

Device	Package	Shipping
BAV23	SOT-143	3000/ Tape&Reel