

P1TX6B-SX51-02A

Product Specification Sheet

ORIGINATOR:	C. ENG	DATE:	3/9/2012
	P1TX6B-SX51-02A Product Specification	DOCUMENT NO. DOC002325	REV A
		SHEET 1 OF 8	

CONFIDENTIAL INFORMATION

1.0 Features

- 5 transmit lanes and 1 return lane over a single multimode fiber
- Low power consumption (1W)
- Up to 1000M
- Mechanical enclosure serves as heat sink while allowing for FCC part 15 Class A compliance
- No manipulating or compressing the data
- Small footprint
- High-speed CML inputs

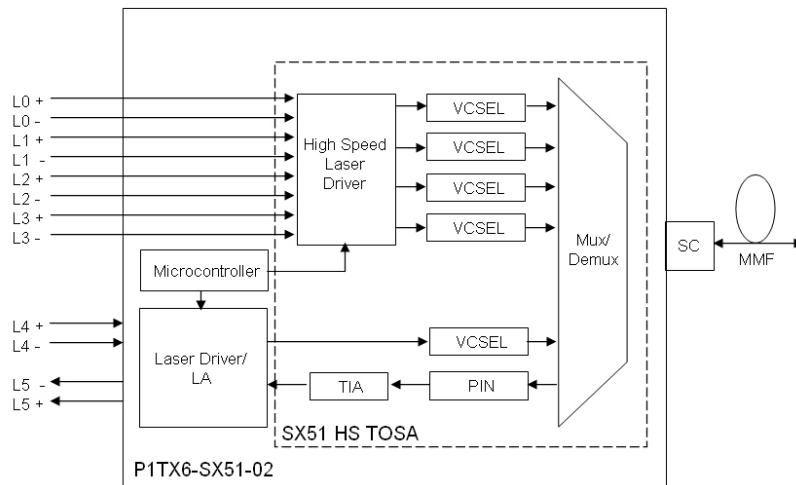

This device is **EXTREMELY SENSITIVE** to Electrostatic Discharge (ESD). At a minimum, all handling must be performed in accordance with an ANSI-compliant ESD Control Program (ANSI/ESD S20.20-2007) to mitigate possible ESD-induced damage. Reliability and life of the device will be adversely affected if these precautions are not met.



This device is a Class 3R Laser device and can cause damage to eye sight if used improperly. Refer to ANSI Z136 for proper handling and usage of Class 3R devices.



ORIGINATOR:	C. ENG	DATE:	3/9/2012
	P1TX6B-SX51-02A Product Specification	DOCUMENT NO.	REV
		DOC002325	A
SHEET 2 OF 8			

2.0 Absolute Maximum Ratings

Parameter	Symbol	Min	Typ	Max	Units
Storage Temperature ¹	Tst				°C
Supply Voltage ^{2 3}	Vcc				V
Operating Surface Temperature ⁴	Ta				°C
Operating Humidity ⁵	RH				%
Durability – SC Connector			200		cycles
Durability – Plug-down Connector			50		cycles
Input Pin Voltage ⁶	V _{IN}				V

3.0 Optical Characteristics – High-speed Lanes

Parameter (per lane)	Symbol	Min	Typ	Max	Units
Average Optical Power, per Lane ⁷	Pout		-1.5		dBm
Optical Modulation Amplitude			0.0		dBm
Center Wavelength – Lane 0			778		nm
Center Wavelength – Lane 1			800		nm
Center Wavelength – Lane 2			825		nm
Center Wavelength – Lane 3			850		nm
Optical Rise/Fall Time ⁸					
P1TX6B-SX51V			200		
P1TX6B-SX51D			100		Ps

¹ Stresses listed may be applied without causing damage. Functionality at or above the values listed is not implied. Exposure to these values for extended periods may affect reliability.

² Supply voltage must be present before input signal may be applied

³ Module must be powered down (OFF) before installation/removal.

⁴ See outline drawing for measurement point.

⁵ Non condensing. Do not operate device if wet.

⁶ Supply voltage must be present before input signal may be applied. Driving the device in a power OFF state may result in permanent damage to the input pins.

⁷ I= 6mA, T=25C.

⁸ Rise and fall times measured from 20 - 80% . Tested with OMRON reference circuits.

ORIGINATOR:	C. ENG	DATE:	3/9/2012
	P1TX6B-SX51-02A Product Specification	DOCUMENT NO. DOC002325	REV A
		SHEET 3 OF 8	

4.0 Electrical Specifications – High-speed Lanes

Parameter	Symbol	Min	Typ	Max	Units
Data Rate per Lane ⁹ P1TX6B-SX51V P1TX6B-SX51D					Gb/s
Total Jitter (RMS), per lane ¹⁰	T _{J1}		10		ps
Input Differential Impedance			100		ohm
Differential Input Voltage ^{2,11}					mVp-p
Single-ended Input Voltage ²					mVp-p
Common mode input voltage ² (AC-coupled input)			2.6		V V
Operating Supply Voltage	V _{cc-Vee}		3.30		V
Operating Supply Current	I _{cc}				mA
Input Data Pattern		DC-balanced			

5.0 Optical Characteristics – Bi-Directional Lanes

Transmit Parameter	Symbol	Min	Typ	Max	Units
Average Optical Power - Lane 4	P _{avg}		-1.5		dBm
Optical Modulation Amplitude			0.0		dBm
Wavelength - Lane 4			911		nm
Optical Rise/Fall Time			2000		Ps

Receive Parameter	Symbol	Min	Typ	Max	Units
Wavelength - Lane 5			980		nm
Data Rate					Mb/s
Peak Optical Input Power	P _{in}				dBm
Peak Optical Modulation Amplitude	P _{in}				dBm
OMA Sensitivity ¹²			-15.00		dBm
Input Data Pattern		DC-balanced			

⁹ Measured with input signals conforming to HDMI rev 1.4a

¹⁰ Based on a jitter-free source

¹¹ Differential CML compatible inputs

¹² Optical Modulation Amplitude. Based on an unstressed input signal.

ORIGINATOR:	C. ENG	DATE:	3/9/2012
	P1TX6B-SX51-02A Product Specification	DOCUMENT NO.	REV
		DOC002325	A
SHEET 4 OF 8			

6.0 Electrical Specifications – Bi-Directional Lanes

Transmit Parameter	Symbol	Min	Typ	Max	Units
Data Rate per Lane					Mb/s
Total Jitter (RMS) ¹³	T _{J1}		25		ps
Input Differential Impedance			100		ohm
Differential Input Voltage – Lane 4 ^{2,14}					mVp-p
Input Data Pattern		DC-balanced			

Receive Parameter	Symbol	Min	Typ	Max	Units
Low Frequency Cutoff	F _{CUTOFF}		35		kHz
Differential Output Voltage ¹⁵	V _{OD}		835		mVp-p
Loss of Signal Assert Sensitivity	LOS _{SEN-ON}		-15.5		dBm
Loss of Signal De-Assert Sensitivity	LOS _{SEN-OFF}		-13.5		dBm
Loss of Signal Output Low ¹⁶	V _{LOS}				V
Loss of Signal Output High	V _{LOS}				V

7.0 Fiber Transmission Distance

Data Rate	OM4 (4700 MHz*km)	OM3 (2000 MHz*km)	OM1 (160 MHz*km)	OM2 (500 MHz*km)	Units
1.65 Gbps	2000	1000	200	400	m
3.40 Gbps	1000	500	100	200	m

8.0 Laser Safety

The P1TX6-SX51-02 meets Class-3R requirements.¹⁷ Use proper eye protection and handling practices per ANSI Z136.

¹³ Based on a jitter-free source

¹⁴ Differential CML compatible inputs

¹⁵ Differential back-terminated CML outputs

¹⁶ This output is asserted low when a loss of signal is detected on all lanes

¹⁷ Lane 4 data input with 50% duty cycle

ORIGINATOR:	C. ENG	DATE:	3/9/2012
	P1TX6B-SX51-02A Product Specification	DOCUMENT NO.	REV
		DOC002325	A
SHEET 5 OF 8			

9.0 Environmental Standards

Omron Network Products designs and manufactures its products to minimize the negative impact on our environment. As such, the P1TX6B-SX51-02 conforms to a variety of environmental and safety standards

Standard	Compliant	Certificate Available
RoHS	Yes	Yes
REACH	Yes	Yes
FCC Part 15 Class A	Yes	No

ORIGINATOR:	C. ENG	DATE:	3/9/2012
	P1TX6B-SX51-02A Product Specification	DOCUMENT NO. DOC002325	REV A
		SHEET 6 OF 8	

10.0 Pin Numbers and Descriptions¹⁸

The TX Data Module contains a 30 pin connector (DF12-30DS-0.5V(86)). For information on the specifications of the mating connector (DF12(4.0)-30DP-0.5V(86)), contact Hirose.

Pin #	Signal	Name	Description
1	GND	Ground	
2	NC	No connect	Reserved for future use
3	+ IN0	Ch 0 + Data Input	Positive differential input for 778nm lane
4	LOS _{BI}	Ch 5 LOS	Loss of Signal – Bi-directional Channel
5	- IN0	Ch 0 - Data Input	Negative differential input for 778nm lane
6	Reset	Reset	Microcontroller Reset ¹⁹
7	+ IN1	Ch 1 + Data Input	Positive differential input for 800nm lane
8	UART	UART_TX	Reserved for future use
9	- IN1	Ch 1 - Data Input	Negative differential input for 800nm lane
10	UART	UART_RX	Reserved for future use
11	+ IN2	Ch 2 + Data Input	Positive differential input for 825nm lane
12	NC	No connect	Reserved for future use
13	- IN2	Ch 2 - Data Input	Negative differential input for 825nm lane
14	NC	No connect	Reserved for future use
15	+ IN3	Ch 3 + Data Input	Positive differential input for 850nm lane
16	EN _{BI}	Enable	Enable ²⁰ – Bi-directional laser
17	- IN3	Ch 3 - Data Input	Negative differential input for 850nm lane
18	EN _{HS}	Enable	Enable ²⁰ – High speed lasers
19	GND	Ground	
20	NC	No connect	Reserved for future use
21	- IN4	Ch 4 - Data Input	Negative differential input for 911nm lane
22	NC	No connect	Reserved for future use
23	+ IN4	Ch 4 - Data Input	Positive differential input for 911nm lane
24	NC	No connect	Reserved for future use
25	+ TD5	Ch 5 - Data Output	Positive differential output for 980nm lane
26	NC	No connect	Reserved for future use
27	- TD5	Ch 5 - Data Output	Negative differential output for 980nm lane
28	VCC ²	Voltage Input	+3.3 volt input
29	GND	Ground	
30	VCC ²	Voltage Input	+3.3 volt input

¹⁸ Verify pin assignments and polarity before powering on device

¹⁹ Reset to be pulled high for normal operation

²⁰ Enable to be pulled up to VCC for normal operation

ORIGINATOR:	C. ENG	DATE:	3/9/2012
	P1TX6B-SX51-02A Product Specification	DOCUMENT NO. DOC002325	REV A
		SHEET 7 OF 8	

11.0 Dimensions

The SX51-02 data module is designed to work with a standard SC ferrule only. Insertion of any other type may result in damage.

Dimensions and orientation are for reference only. Customers can request final, detailed dimensions, or a CAD drawing, through your Omron sales representative.

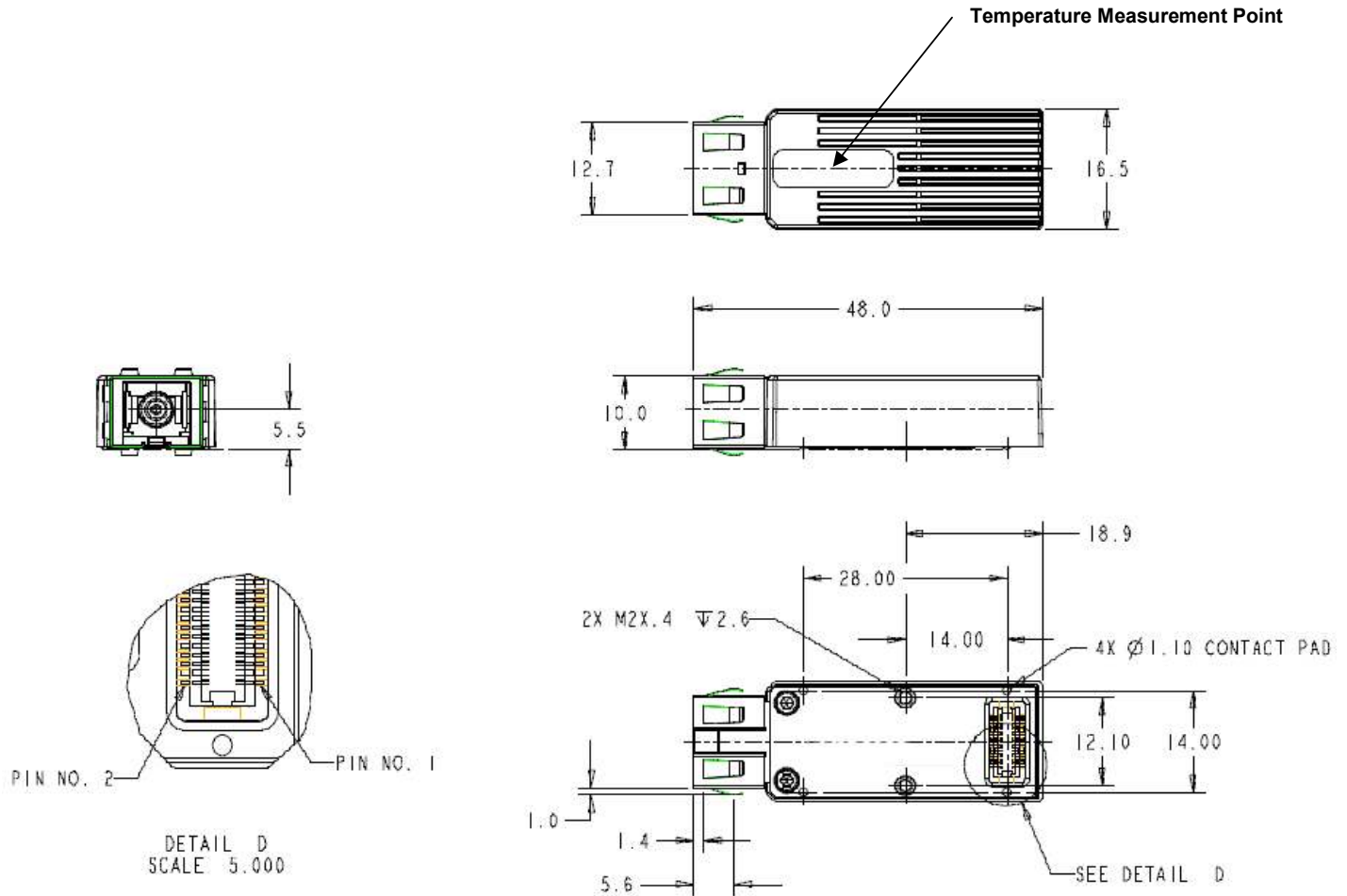

Dimensions are in mm

ORIGINATOR:	C. ENG	DATE:	3/9/2012
	P1TX6B-SX51-02A Product Specification	DOCUMENT NO. DOC002325	REV A
		SHEET 8 OF 8	