



LR1125

CMOS IC

500mA, LOW-VOLTAGE LINEAR REGULATOR

DESCRIPTION

The UTC **LR1125** is a positive LDO (voltage linear regulator) operates from a 2.25V ~ 5.5V supply and delivers a guaranteed 500mA load current with low 175mV dropout. Low dropout voltage and large output current can be provided by built-in low on-resistance transistor. Because an internal PMOS pass transistor allows low 210µA supply current, the LR1125 can be ideal for portable equipment such as PDAs, cellular phones, cordless phones, and other equipments including base stations and docking stations. It also includes an active-low, power-OK output that mean a 0.02µA shutdown mode, short-circuit protection and thermal-shutdown protection when the output is out of regulation.

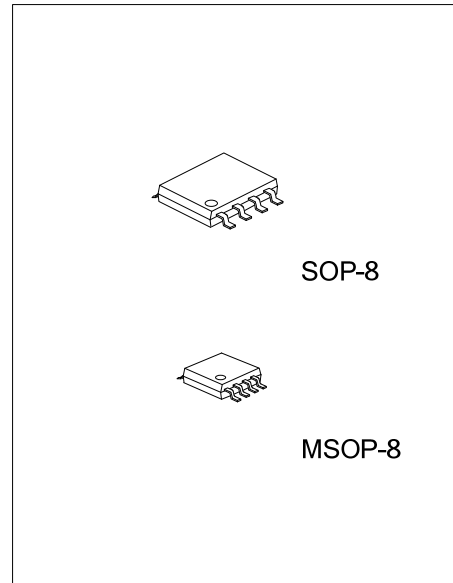

FEATURES

- * Low Dropout: 175mV Dropout at 500mA
- * High accuracy output voltage: +/- 1.5%
- * Guaranteed Output:500mA
- * Thermal-Overload Protection
- * Internal Current Limiting
- * Low 210µA Ground Current
- * 0.02µA Shutdown Current
- * V_{OUT} Can Be Adjusted From 0.8V ~ 4.5V

ORDERING INFORMATION

Ordering Number	Package	Packing
LR1125G-S08-R	SOP-8	Tape Reel
LR1125G-SM1-R	MSOP-8	Tape Reel

<p>LR1125G-SM1-R</p> <p>(1) Packing Type</p> <p>(2) Package Type</p> <p>(3) Halogen Free</p>	<p>(1) R: Tape Reel, T: Tube</p> <p>(2) SO8: SOP-8, SM1: MSOP-8</p> <p>(3) G: Halogen Free</p>
----------------------------------------------------------------------------------------------	------------------------------------------------------------------------------------------------

■ PIN CONFIGURATION

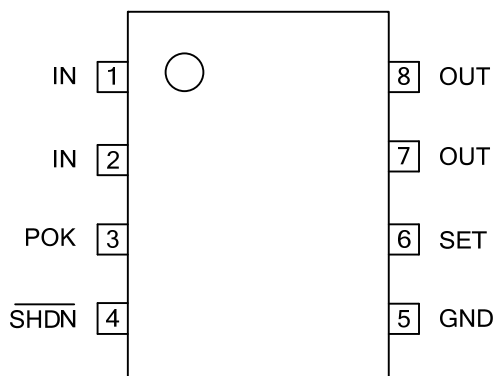

■ PIN DESCRIPTION

PIN NO	PIN NAME	DESCRIPTION
1, 2	IN	Input. Supply voltage: 2.25V ~ 5.5V. Bypass with a 1 μ F capacitor to GND. Connect both input pins together.
3	POK	Open-Drain, Active-Low Power-OK Output. While the output voltage (V_{OUT}) is below the POK threshold, this pin remains low. Connect a 100k Ω pullup resistor to OUT.
4	$\overline{\text{SHDN}}$	Active-Low Shutdown Input. At this pin, a logic low reduces supply current to 0.02 μ A. In shutdown, the POK output is low. For normal operation Connect SHDN to IN.
5	GND	Ground.
6	SET	Voltage-Setting Input. For preset output, connect this pin to GND. Connect an external resistive voltage-divider from OUT to this pin to set the output voltage from 0.8V to 4.5V. This pin regulation voltage is 800mV.
7, 8	OUT	Regulator Output (up to 500mA). This pin should be bypassed with a 10 μ F low-ESR capacitor to GND. Connect both OUT pins together.

■ ABSOLUTE MAXIMUM RATING

PARAMETER	SYMBOL	RATINGS	UNIT
IN, SHDN, POK, SET to GND		-0.3~+6	V
OUT to GND		-0.3~(V _{IN} +0.3)	V
Output Short-Circuit Duration	I _D	continuous	
Power Dissipation (T _a =70°C)	P _D	1.95	W
Junction Temperature	T _J	+150	°C
Operating Temperature	T _{OPR}	-40~+85	°C
Storage Temperature Range	T _{STG}	-65~+150	°C

Note: Absolute maximum ratings are those values beyond which the device could be permanently damaged.

Absolute maximum ratings are stress ratings only and functional device operation is not implied.

■ ELECTRICAL CHARACTERISTICS (V_{IN}=V_{OUT(SETPOINT)}+500mV or V_{IN}=2.25V which is greater, SET=GND, SHDN=IN, unless otherwise specified. Typical values are at T_a=25°C)

T_a=0°C~85°C

PARAMETER	SYMBOL	TEST CONDITIONS	MIN	TYP	MAX	UNIT
Input Voltage	V _{IN}		2.25		5.50	V
Input Undervoltage Lockout	V _{UVLO}	Rising, 40mV hysteresis	1.85	2	2.15	V
Output Voltage Accuracy (Preset Mode)	V _{OUT}	I _{OUT} =100mA	-1.5		+1.5	%
		I _{OUT} =1mA ~ 500mA	-2.5		+2.5	
		T _a =0°C ~85°C, I _{OUT} =1mA~500mA, V _{IN} >V _{OUT} +0.5V	-3		+3	
Adjustable Output Voltage			0.8		4.5	V
SET Voltage Threshold (Adjustable Mode)	V _{SET}	I _{OUT} =100mA	788		812	mV
		I _{OUT} =1mA ~ 500mA	780		820	
		T _a =0°C ~85°C, I _{OUT} =1mA~500mA, V _{IN} >V _{OUT} + 0.5V	774	800	826	
Maximum Output Current	I _{OUT}		500			mA
Short-Circuit Current Limit	I _{LIMIT}	V _{OUT} =0V	600	1400	2300	mA
SET Dual Mode Threshold			35	80	125	mV
SET Input Bias Current	I _{SET}	V _{SET} =0.8V	-100		+100	nA
Ground-Pin Current	I _Q	I _{OUT} =1mA		210	600	μA
		I _{OUT} =500mA		575		
Dropout Voltage (Note 1)	V _D	I _{OUT} = 500mA, V _{OUT} =2.25V		259	400	mV
		I _{OUT} = 500mA, V _{OUT} =2.8V		201	350	
		I _{OUT} = 500mA, V _{OUT} =4V		147	275	
Line Regulation	ΔV _{LNR}	V _{IN} from (V _{OUT} +100mV)~5.5V, I _{LOAD} =5mA		0	0.125	%/V
Load Regulation	ΔV _{LDR}	I _{OUT} =1mA ~500mA		15.5	35	ppm/mA
Output Voltage Noise		10Hz~1MHz, C _O =10μF (ESR<0.1Ω)		300		μV _{RMS}
SHUTDOWN						
Shutdown Supply Current	I _{OFF}	SHDN = GND, V _{IN} = 5.5V		0.02	5	μA
SHDN Input Threshold	V _{IH}		1.6			V
	V _{IL}				0.6	
SHDN Input Bias Current	I _{SHDN}	SHDN = GND or IN		10	100	nA
Startup Time	t _{START}	C _O =10μF, time from SHDN high to POK high		40		μs

■ ELECTRICAL CHARACTERISTICS(Cont.)

PARAMETER	SYMBOL	TEST CONDITIONS	MIN	TYP	MAX	UNIT
POWER-OK						
POK Output Low Voltage	V_{OL}	Sinking 2mA		5	50	mV
Operating Voltage Range for Valid POK Output		Sinking 100 μ A	1.0		5.5	V
Output High Leakage Current		$V_{POK}=5.5V$			100	nA
Threshold		Rising edge, referred to V_{OUT}	90	93	96	%
THERMAL PROTECTION						
Thermal-Shutdown Temperature	T_{SHDN}			170		$^{\circ}C$
Thermal-Shutdown Hysteresis	ΔT_{SHDN}			20		$^{\circ}C$

$T_a = -40^{\circ}C \sim 85^{\circ}C$ (Note 2)

PARAMETER	SYMBOL	TEST CONDITIONS	MIN	TYP	MAX	UNIT
Input Voltage	V_{IN}		2.25		5.50	V
Input Under Voltage Lockout	V_{UVLO}	Rising, 40mV hysteresis	1.85		2.15	V
Output Voltage Accuracy (Preset Mode)	V_{OUT}	$I_{OUT}=1mA \sim 500mA$	-4		+4	%
Adjustable Output Voltage	$V_{OUT(ADJ)}$		0.8		4.5	V
SET Voltage Threshold (Adjustable Mode)	V_{SET}	$I_{OUT}=1mA \sim 500mA$	766		834	mV
Maximum Output Current	I_{OUT}		500			mA
Short-Circuit Current Limit	I_{LIM}	$V_{OUT}=0V$	600		2500	mA
SET Dual Mode Threshold			35		125	mV
SET Input Bias Current	I_{SET}	$V_{SET}=0.8V$	-100		+100	nA
Ground-Pin Current	I_Q	$I_{OUT}=1mA$			400	μ A
SHUTDOWN						
Shutdown Supply Current	I_{OFF}	$\overline{SHDN}=\overline{GND}, V_{IN}=5.5V$			5	μ A
\overline{SHDN} Input Threshold	V_{IH}	$2.5V < V_{IN} < 5.5V$	1.6			V
	V_{IL}	$2.5V < V_{IN} < 5.5V$			0.6	
\overline{SHDN} Input Bias Current	$I_{\overline{SHDN}}$	$\overline{SHDN}=\overline{GND}$ or IN		10	100	nA
POWER-OK						
POK Output Low Voltage	V_{OL}	Sinking 2mA			50	mV
Operating Voltage Range for Valid POK Output		Sinking 100 μ A	1.0		5.5	V
Output High Leakage Current		$V_{POK}=5.5V$			100	nA
Threshold		Rising edge, referred to V_{OUT}	89		97	%

Note 1. Dropout voltage is $V_{IN} - V_{OUT}$. For $2.25V \leq V_{OUT} \leq 4V$, dropout voltage limits are linearly interpolated from the values listed. For $V_{OUT} < 4V$, dropout voltage limit is equal to the value for $V_{OUT} = 4V$.

2. Specifications to $-40^{\circ}C$ are guaranteed by design, not production tested.

■ TYPICAL APPLICATION CIRCUIT

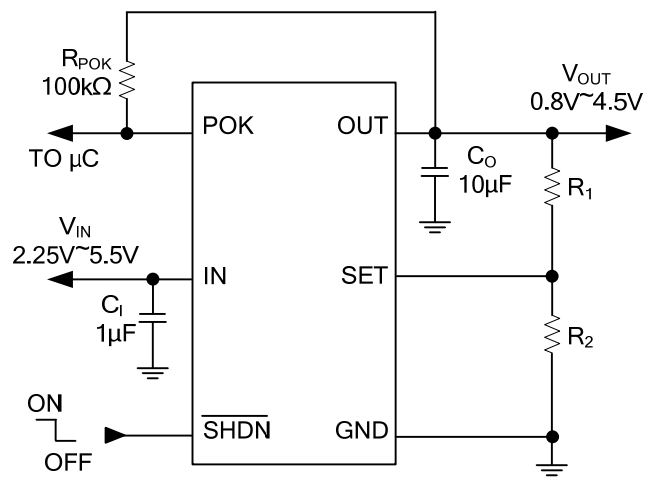

- TYPICAL CHARACTERISTICS ($V_{OUT} = 3.3V$, $V_{IN} = V_{OUT} + 500mV$, SHDN = IN, $C_{IN} = 1\mu F$, $C_{OUT} = 10\mu F$, $T_A = +25^\circ C$, unless otherwise noted.)

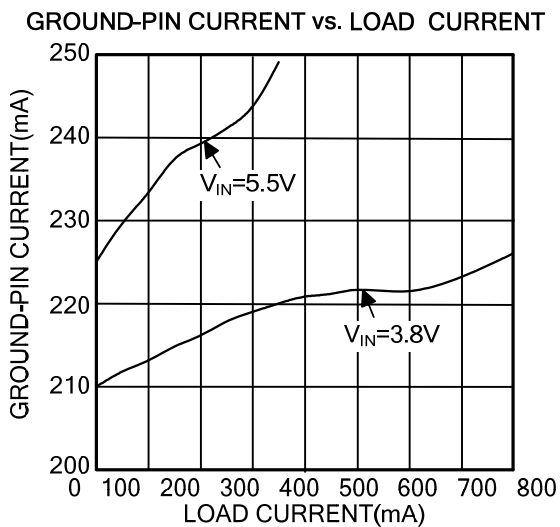
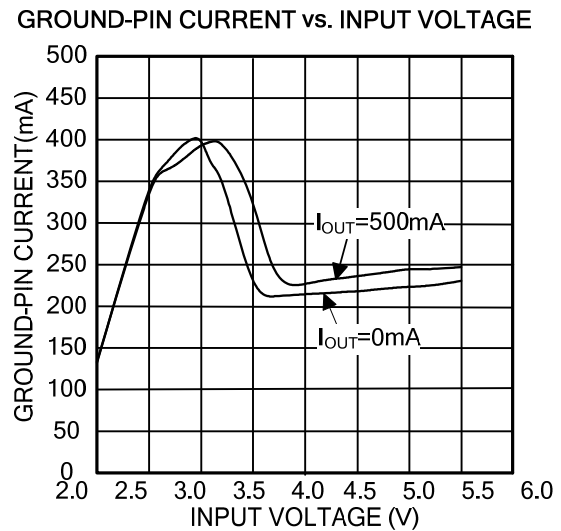
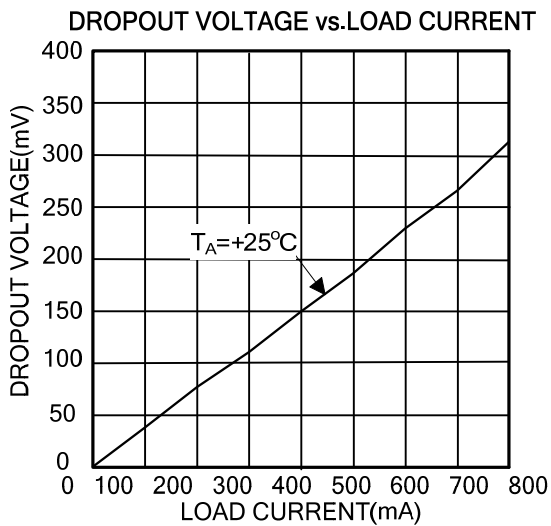
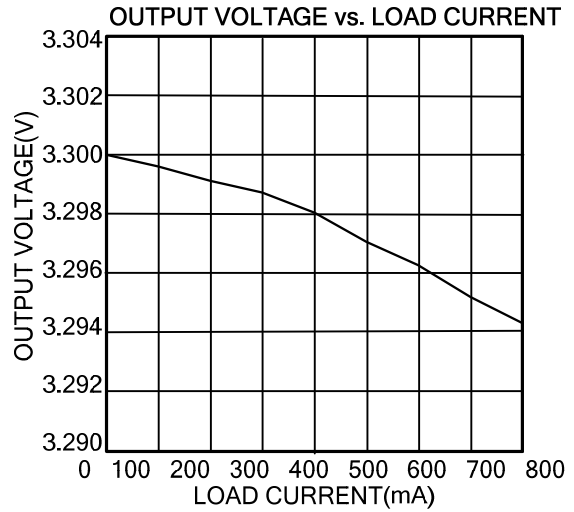
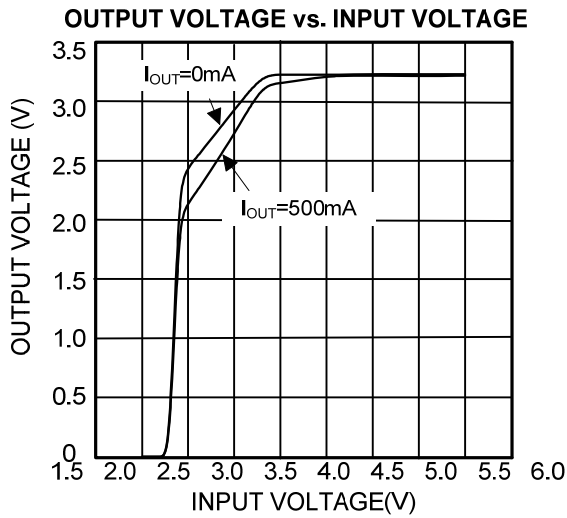

■ TYPICAL CHARACTERISTICS (Cont.)

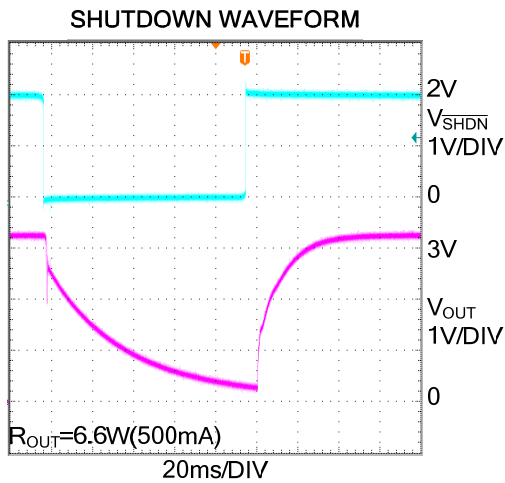
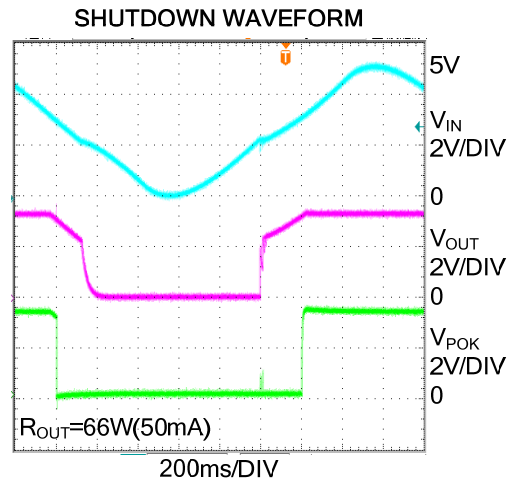
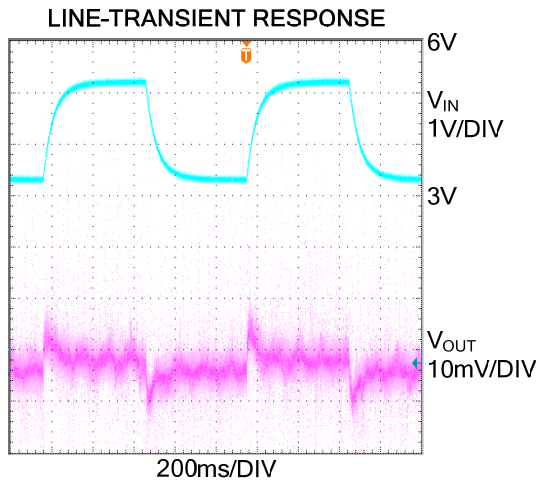

UTC assumes no responsibility for equipment failures that result from using products at values that exceed, even momentarily, rated values (such as maximum ratings, operating condition ranges, or other parameters) listed in products specifications of any and all UTC products described or contained herein. UTC products are not designed for use in life support appliances, devices or systems where malfunction of these products can be reasonably expected to result in personal injury. Reproduction in whole or in part is prohibited without the prior written consent of the copyright owner. The information presented in this document does not form part of any quotation or contract, is believed to be accurate and reliable and may be changed without notice.