

1. Scope of Application

This data sheet is applied to the chip type LED lamp, model CL-L233-MC13L2-C.

2. Part code

CL - L 2 3 3 - M C 1 3 L 2 - C

Series _____

L233 : White power LED for general lighting.

Special specifications _____

M : General Color Rendering Index Typ. 85 Type.

Watt class _____

C13 : 13 watt package.

Lighting color _____

L2 : Compliance with ANSI C78.377-2008,
3-step MacAdam ellipse,
Correlated Color Temperature K.

Symbol	CITILED
Name	CL-L233-MC13L1-C
CITIZEN ELECTRONICS CO.,LTD. JAPAN	

3. Outline drawing

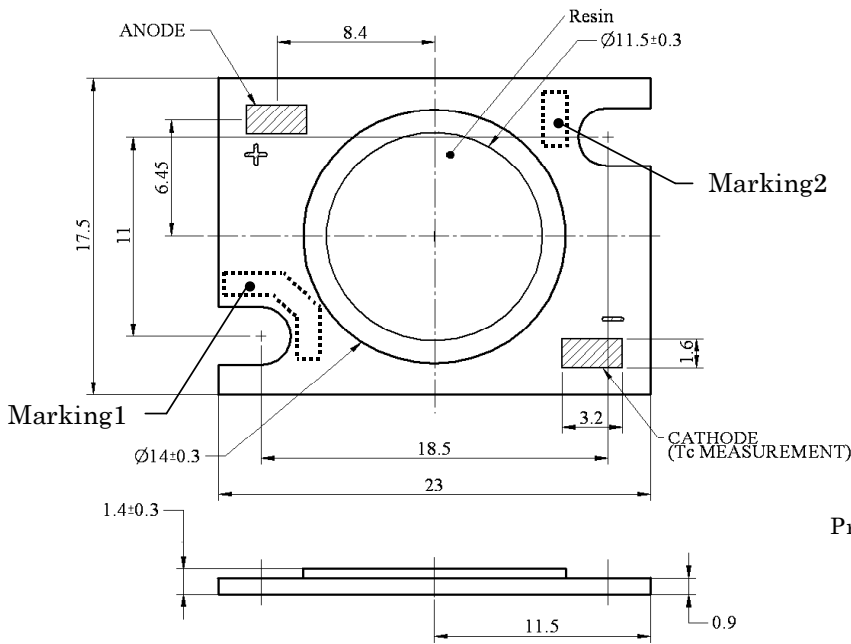

Unit : mm
Tolerances unless otherwise specified : ±0.3

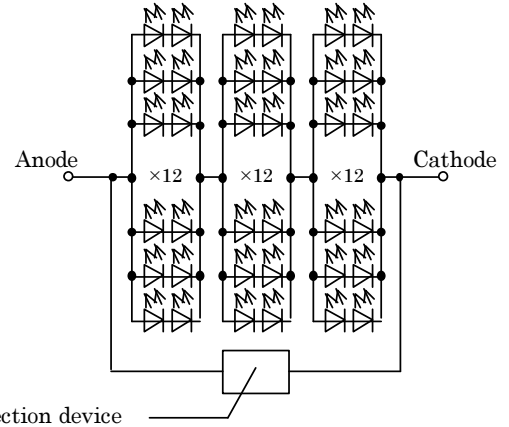

It has a protection device built in as a protection circuit against static electricity.

Marking1 : Serial No.

Marking2 : M L2

Color L2
Ra M : Typ.85

4. Performance

(1) Absolute Maximum Rating

Parameter	Symbol	Rating Value	Unit
Power Dissipation	P_D	32.8	W
Forward Current	I_F	1,440	mA
Forward Pulse Current	I_{FP}	1,500	mA
Reverse Current	I_R	1	mA
Operating Temperature	T_{OP}	-30 ~ +85	C
Storage Temperature	T_{ST}	-40 ~ +100	C
Junction Temperature	$T_{j\ Max}$	150	C

*1

*2

*1 Forward Current : Duty ≤ 1/10 , Pulse Width ≤ 10msec

*2 D.C. Current : $T_j = T_c + R_{j-c} \times P_D$

Pulse Current : $T_j = T_c + R_{j-c} \times P_w$ (Power Dissipation / One-Pulse) × Duty

Symbol	CITILED
Name	CL-L233-MC13L2-C
CITIZEN ELECTRONICS CO.,LTD. JAPAN	

(2) Electro-optical Characteristics

(T_c=25 C)

Parameter	Symbol	Condition	Min.	Typ.	Max.	Unit
Forward Voltage	V _F	I _F =720mA	17.5	18.6	21.0	V
Luminous Flux	Φ _v	I _F =720mA	755	885	-	lm
General Color Rendering Index	R _a	I _F =720mA	80	85	-	-
Thermal Resistance	R _{j-c}	J _{unction} -case	-	2.4	-	C/W

Chromaticity coordinates (Condition : I_F=720mA , T_c=25 C)

Color rank L2	Center	
	x	y
	0.4578	0.4101
	Oval parameter	
	a	0.00774
	b	0.00411
θ°	57.28	

Reference (ANSI C78.377)

Color rank L2	Center		(2725K)
	x	y	
	0.4578	0.4101	
	Color region		
	a	0.4813	
	b	0.4562	
c	0.4373		
d	0.4593		

*Color region stay within MacAdam "3-step" ellipse from the chromaticity center.

*The chromaticity center refers to ANSI C78.377:2008.

Please refer to ANSI C78.377 for the chromaticity center.

*θ is the angle between the major axis of the ellipse and the x-axis,

and a and b are the major and minor semi-axes of an ellipse. (Ref. IEC 60081:1997 AnnexD)

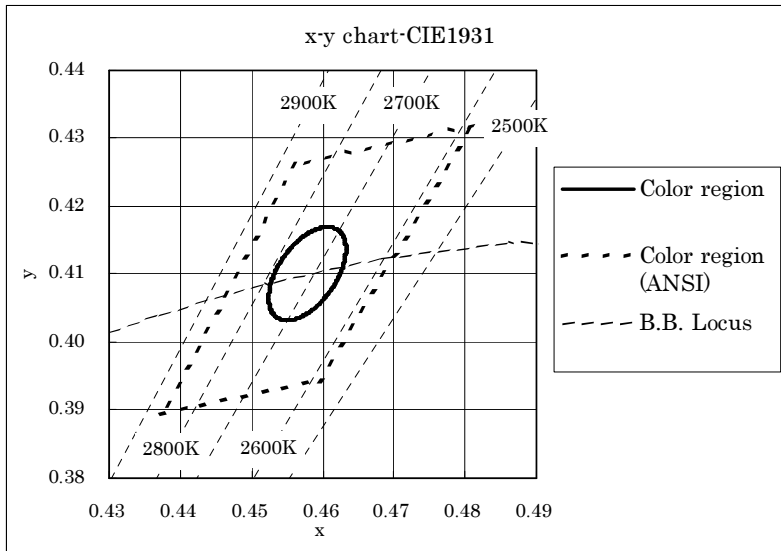

Note: The tolerance of measurement at our tester is V_F±3% , Φ_v±10% , Chromaticity(x,y)±0.005.

Symbol	CITILED
Name	CL-L233-MC13L2-C
CITIZEN ELECTRONICS CO.,LTD. JAPAN	

5. Characteristics

• Forward Current vs. Forward Voltage

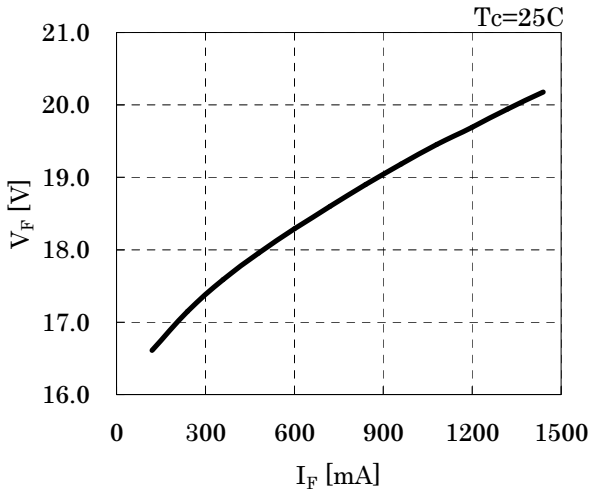

• Forward Current vs. Relative Luminous Flux

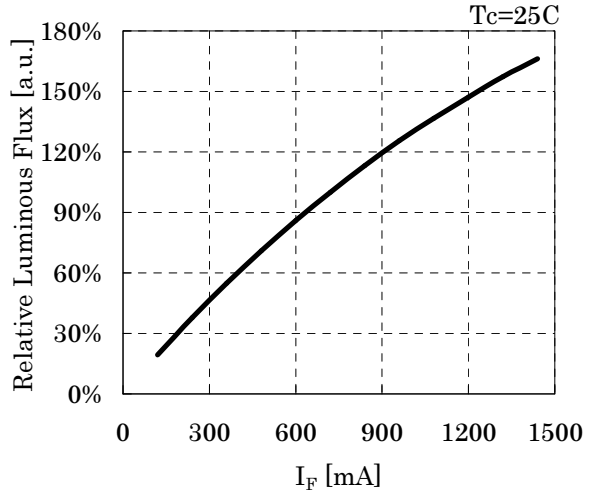

• Forward Current vs. Chromaticity Coordinate

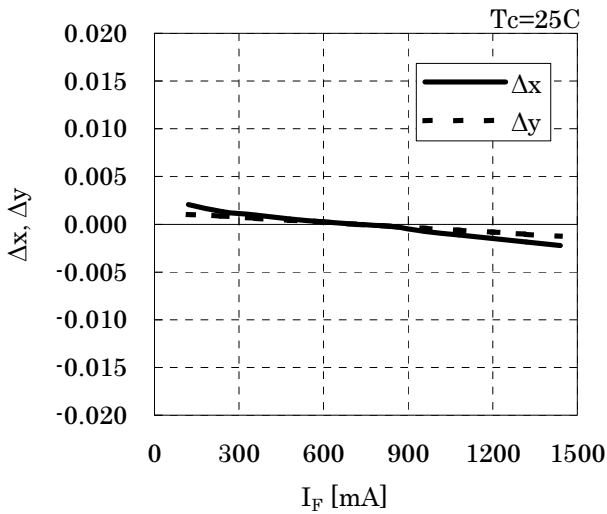

• Case Temperature vs. Chromaticity Coordinate

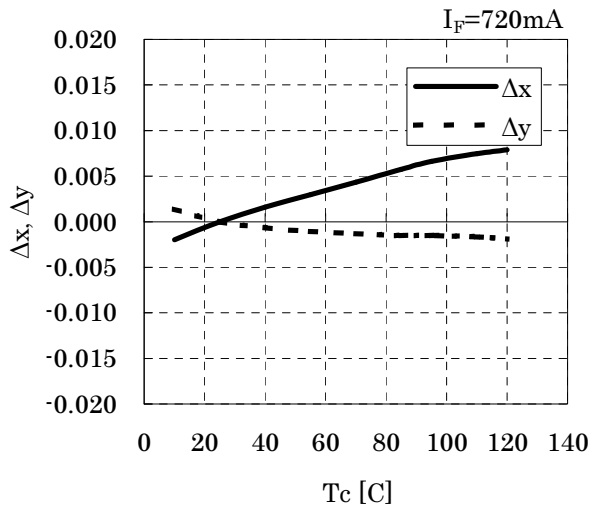

Symbol	CITILED
Name	CL-L233-MC13L2-C
CITIZEN ELECTRONICS CO.,LTD. JAPAN	

• Case Temperature vs. Forward Voltage

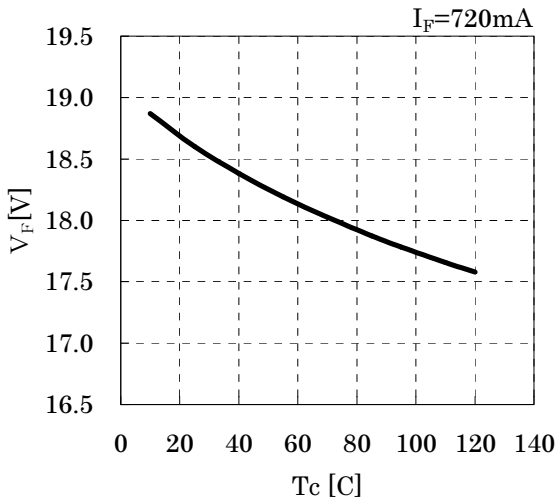

• Case Temperature vs. Relative Luminous Flux

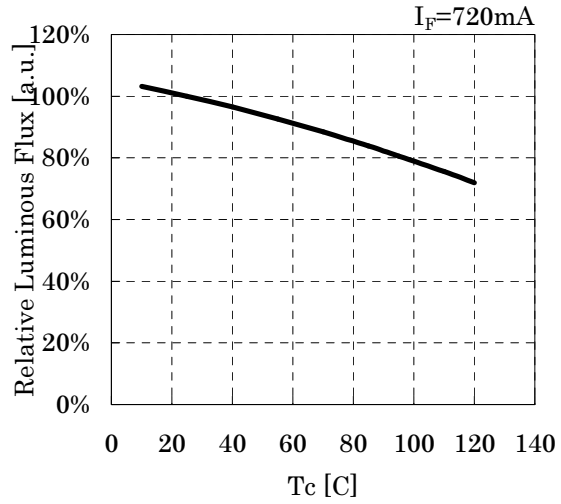

• Case Temperature vs. Allowable Forward Current

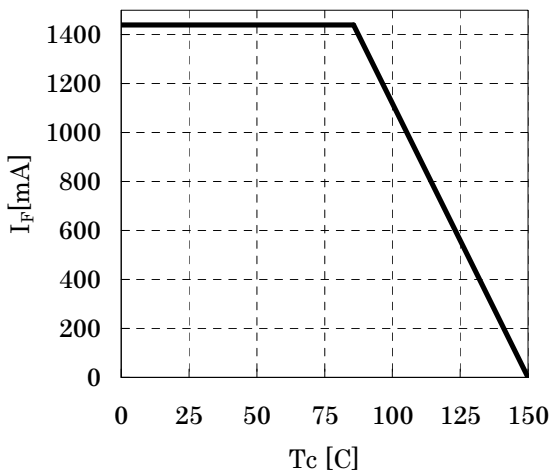

• Spectrum

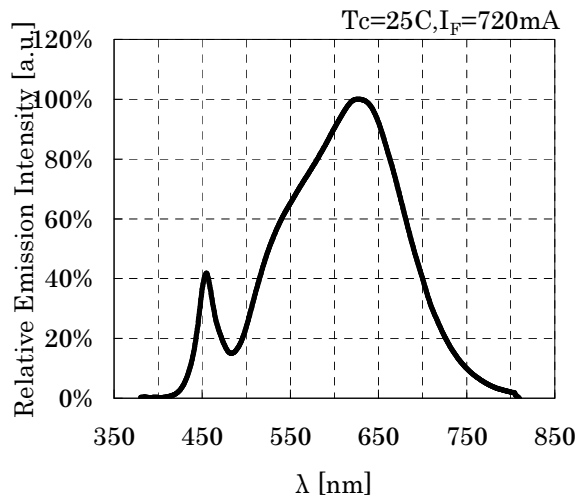

Symbol	CITILED
Name	CL-L233-MC13L2-C
CITIZEN ELECTRONICS CO.,LTD. JAPAN	

6. Reliability

(1) Details of the tests

Test Item	Test Condition
Continuous Operation Test	Ta=25 C, I _F =720 mA× 1000 hours(with Al-fin)
	Ta=80 C, T _j ≦ 120 C, I _F =720 mA× 1000 hours(with Al-fin)
Low Temperature Storage Test	-40 C × 1000 hours
High Temperature Storage Test	100 C × 1000 hours
Moisture-proof Test	60 C, 90 %RH for 1000 hours
Thermal Shock Test	-40 C × 30 minutes – 100 C × 30 minutes, 100 cycle

(2) Judgment Criteria of Failure for Reliability Test (Ta=25 C)

Measuring Item	Symbol	Measuring Condition	Judgment Criteria for Failure
Forward Voltage	V _F	I _F =720mA	> U × 1.1
Total Luminous Flux	Φ _v	I _F =720mA	< S × 0.85

U defines the upper limit of the specified characteristics. S defines the initial value.

Note: Measurement shall be taken between 2 hours and 24 hours, and the test pieces should be returned to the normal ambient conditions after the completion of each test.

CL-L221-C14L1 reliability test results will be used for CL-L233-MC13L2-C.

Symbol	CITILED
Name	CL-L233-MC13L2-C
CITIZEN ELECTRONICS CO.,LTD. JAPAN	

7. Packing Specifications

(1) Packing

An empty tray is placed on top of a five-tier tray which contain 40 pieces each. The set of six trays is banded together with two rubber bands.
 (Smallest packing unit: 200 pieces)
 A label with product name, quantity, lot number is placed on the upper empty tray.

Tray (Dimensions: 310 × 210 × 14.6mm / Materials: Electrically conductive PS)

< Packing figure >

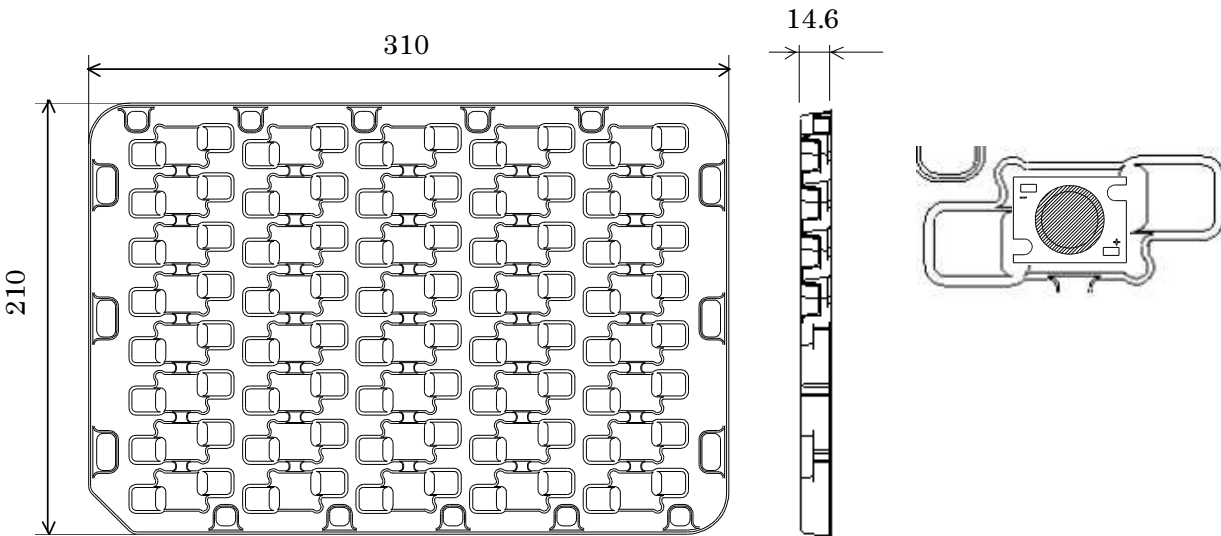

Product 40pcs/tray

< Example of indication label >

CUSTOMER			
TYPE	CL-L233-MC13L2-C	---(1)	
P.NO	xxx	---(2)	
LOT No	03D001	---(3)	
Q'ty	200 pcs.	---(4)	
CITIZEN ELECTRONICS			

1. TYPE e.g. CL-L233-MC13L2-C
2. P.No. (Customer's P/N) e.g. xxx
3. Lot No. e.g. 03D001
 - First letter: Last digit of the year e.g. 0 : year 2010
 - Second letter: Production month e.g. 3 : Mar
 Note: October, November and December are designated by X, Y and Z, respectively.
- Third letter: CE's control number e.g. D001
4. Quantity e.g. 200 pieces

Symbol	CITILED
Name	CL-L233-MC13L2-C
CITIZEN ELECTRONICS CO.,LTD. JAPAN	

8. Precautions

1. Avoid the application of any stress to the resin portion.
2. Avoid any contact by a sharp metal nail or other materials with the resin portion.

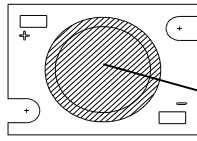

Resin portion (Shaded area)

3. This product should be secured firmly by fastening an M3 screw on both sides of the product. Please be careful not to apply any stress to the product during the clamping operation. As the connection status could vary depending on materials of outer heat sink, please check thoroughly.

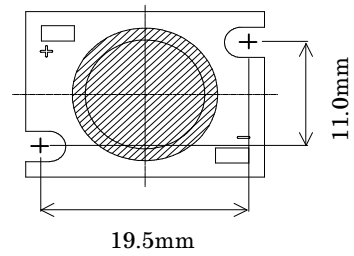
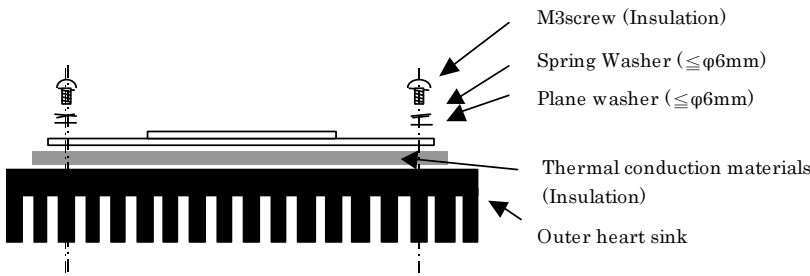

Recommended installation screw pitch

4. Insulation between the terminal section and the heat sink section of the LED is not covered by warranty. With regard to insulation after this product has been assembled in an apparatus, preventive action should be carried out by the customer.
5. For fixing this product to the outer heat sink, heat grease should be applied to the whole rear surface so that the product can dissipate heat as a whole. Please pay attention to avoid product deformation when conducting the clamping operation with heat grease in sheet form.

6. Handling of static electricity

- These products are sensitive to static electricity charge. Please take measures to prevent any static electricity being produced such as the wearing of a wristband or anti-static gloves when handling this product.
- All devices, equipment and machinery must be properly grounded. It is recommended that precautions be taken against surge voltage to the equipment that mounts the LEDs.
- ESD sensitivity of this product is 1000V (HBM, based on JEITA ED-4701/304).
- When inspecting the final products in which LEDs were assembled, it is recommended to check whether the assembled LEDs are damaged by static electricity or not.
- It is easy to find static-damaged LEDs by a light-on test.

<Light-on test criterion>

Condition	Judgmental criterion
$I_F=12mA/PKG$	No-lighting in entire block making up parallel circuit is unacceptable

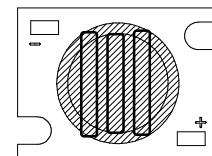

L233 consists of three blocks.

Symbol	CITILED
Name	CL-L233-MC13L2-C
CITIZEN ELECTRONICS CO.,LTD. JAPAN	

8. Precautions (continued)

7. Lighting at a low current

A minimum current value of lighting of all dice is 60mA.

When a minimal current is applied, LED dice may look different in their brightness due to the individual difference of the LED element, and it is not a failed product.

8. Please be aware that this product should not come into contact with any other parts in assembled status.

9. Drive circuit

- A constant current circuit is recommended as a drive circuit.

And when two or more LED packages are connected, the series connection between each package is recommended.

- Please design a circuit that prevents any reverse voltage (excess current) from being applied to this product instantaneously when the circuit is ON or OFF.

10. Heat generation

- As this product is designed with consideration of the heat release property of module, a heat release design is required to use this product efficiently.

Please ensure that heat generation is not in excess of the absolute maximum rating. (Refer to 4-1 Performance)

- Factors responsible for an increase in temperature include heat generation attributed to ambient temperature conditions or power dissipation. Thus, drive conditions should be taken into consideration, depending on ambient temperature (Ta).

11. Recommended soldering condition (This product is not adaptable to reflow process)

- Manual soldering

- Soldering shall be implemented using a soldering bit of 40W or less with a temperature 350°C or less within 3.5 seconds for one land.

(Recommended condition in a case of lead-free solder condition)

- No external force shall be applied to resin part during soldering.

- Next process of soldering should be carried out after the product has returned to ambient

- For soldering correction

- Regarding soldering correction, above conditions shall be used.

- Contacts number of soldering bit should be within twice for each terminal as a correction.

* Citizen Electronics cannot guarantee if usage exceeds this recommended conditions.

Please use it after sufficient verification is carried out on your own risk if necessary.

12. Other

- This product complies with RoHS directives.

Symbol	CITILED
Name	CL-L233-MC13L2-C
CITIZEN ELECTRONICS CO.,LTD. JAPAN	

9. Warranty

1. CITIZEN ELECTRONICS guarantees the term of the reliability test results and elementary substances of the supplies to be within the set conditions.
Please note that any accident/damage that occurs during or because of usage that deviates from the conditions contained in the specifications are not warrantable.
2. Although CITIZEN ELECTRONICS will deliver products of quality assured by the terms included in these specifications, incorporation in actual machines, lifetime in actual use and another quality shall be confirmed sufficiently by customers.
Customers are responsible for ensuring quality and to meet the specifications such as with regard to the security / the performance to standards of safety / reliability of the finished product.
3. The use of this product is intended for use in general electronics such as business machines, communication equipment, audio-visual equipment, household electrical appliances and measurement devices, etc.
4. If this product is considered to be used in applications where high reliability is required and failure or malfunction have a direct influence on human life or health such as aerospace instrument, medical equipment, atomic energy control devices and so on, please contact Citizen Electronics beforehand.

10. Action for failed product

1. If a failed product is found, action shall be taken after consultation between both sides.
However, in cases where it is obvious that the relevant failed product is attributed to CITIZEN ELECTRONICS, action will be limited to product replacement delivery.
2. When a failed product is returned, the failure phenomenon should be specified in writing and attached.
CITIZEN ELECTRONICS will review the condition promptly and report the result to the customer.

11. Others

1. All matters of this product's quality with regard to the customer are mentioned in these specifications, and any matters which are not mentioned in these specifications in items stated prior to receipt shall lose efficacy.
2. When a question occurs about the contents of these specifications, please contact CITIZEN ELECTRONICS.
In addition, if there is any discrepancy in the contents of these specifications, both sides shall handle the matter with gentlemanlike discussion.
3. Please do not conduct any actions equal to reverse-engineering such as the disassembling or the analysis of this product without CITIZEN's permission.
Please contact CITIZEN directly without disassembling in any way if a failure is found in this product.
4. If this product is not returned within three weeks after this specification has been published, it is judged that the contents have been accepted.

Symbol	CITIED
Name	CL-L233-MC13L2-C
CITIZEN ELECTRONICS CO.,LTD. JAPAN	