

CONNECTORS WITHOUT BRIDGE OPTION

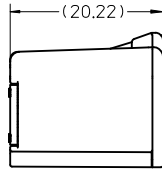

TPS SHOWN IN FULLY SEATED POSITION

SCOOP PROOF RIBS FOR CIRCUIT SIZES 14 THROUGH 20 ONLY

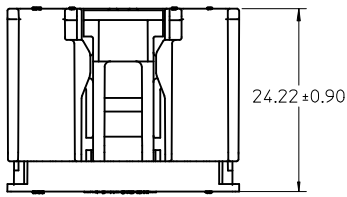
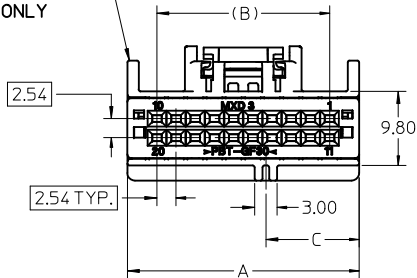

20 CIRCUIT HARNESS ASSEMBLY SHOWN

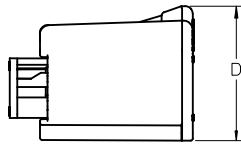

WITH TPA IN PRE-LOAD (AS SHIPPED)

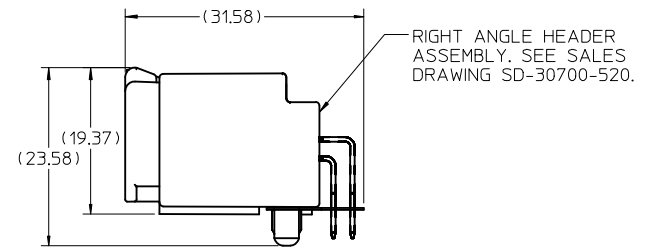
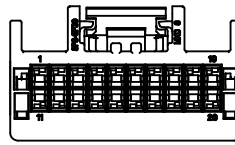

MATED VIEW

RIGHT ANGLE HEADER ASSEMBLY. SEE SALES DRAWING SD-30700-520.

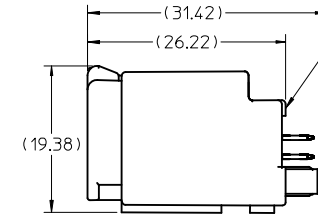

MATED VIEW

VERTICAL HEADER ASSEMBLY. SEE SALES DRAWING SD-30700-420.

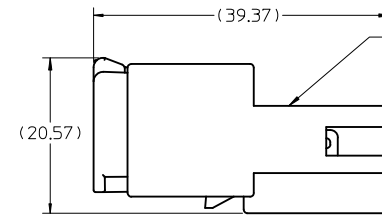

MATED VIEW

MALE INLINE HARNESS ASSEMBLY. SEE SALES DRAWING SD-30968-120.

CONNECTORS WITH BRIDGE OPTION

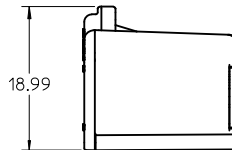
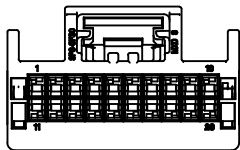

20 CIRCUIT HARNESS ASSEMBLY SHOWN

NOTES:

1. MATERIAL: HOUSING: SPS, GLASS FILLED, COLOR: SEE CHART. TPA: PBT, GLASS FILLED, COLOR: RED.
2. PRODUCT SPECIFICATION: PS-30700-0001
3. PACKAGING SPECIFICATION: PK-30907-417
4. MATES WITH: SERIES 30700 & 30968, SEE SALES DRAWINGS SD-30700-520, SD-30700-420 & SD-30968-120.

EC NO: UAU2010-1798 DRWN: VDANELE 2010/06/04 CHKD: CKRISHNA 01/03/27 APPR: SMARCEAU2010/06/16	QUALITY SYMBOLS ▽ - 0 ∇ - 0	GENERAL TOLERANCES (UNLESS SPECIFIED)		SCALE 2:1	DESIGN UNITS METRIC	THIRD ANGLE PROJECTION	REVISE ON CAD ONLY	
		mm	INCH	DIMENSION STYLE MM ONLY		TITLE 6-20 CIRCUIT HARNESS ASSEMBLY		
		4 PLACES ± --- ± ---	3 PLACES ± --- ± ---	DRAWN BY RCARLSON	DATE 01/03/23	MOLEX INCORPORATED		
		2 PLACES ± 0.13 ± ---	1 PLACE ± 0.25 ± ---	CHECKED BY CKRISHNA	DATE 01/03/27			
ANGULAR ± 1/2°		DRAFT WHERE APPLICABLE		APPROVED BY LGIEIB	DATE 01/03/28	MATERIAL NO. SEE CHART	DOCUMENT NO. SD-30700-120	SHEET NO. 1 OF 3
MUST REMAIN WITHIN DIMENSIONS		THIS DRAWING CONTAINS INFORMATION THAT IS PROPRIETARY TO MOLEX INCORPORATED AND SHOULD NOT BE USED WITHOUT WRITTEN PERMISSION						

ASSEMBLY PART NUMBER		POLARIZATION OPTIONS & CIRCUIT SIZE		PRODUCT DIMENSIONS					PASS THRU HOLE DIA FOR HARNESS	MATING INTERFACE DIMENSIONS	
WITHOUT BRIDGE	WITH BRIDGE	HARNESS ASSEMBLY (POLARIZATION OPTIONS)	CIRCUIT SIZE	A REF.	(B)	C	D	HOUSING COLOR		E	F
30700-1207	31389-1207	POLARIZATION OPTION #1	20	30.69	22.86	12.35	17.79	GRAY	36.5	12.57	31.14
30700-1208	31389-1208	POLARIZATION OPTION #2	20	30.69	22.86	15.35	17.79	BLACK	36.5	15.57	31.14
30700-1209	31389-1209	POLARIZATION OPTION #3	20	30.69	22.86	18.35	17.79	NATURAL (CREAM)	36.5	18.57	31.14
30700-1187	31389-1187	POLARIZATION OPTION #1	18	28.15	20.32	11.08	17.79	GRAY	34.0	11.31	28.60
30700-1188	31389-1188	POLARIZATION OPTION #2	18	28.15	20.32	14.08	17.79	BLACK	34.0	14.31	28.60
30700-1189	31389-1189	POLARIZATION OPTION #3	18	28.15	20.32	17.08	17.79	NATURAL (CREAM)	34.0	17.31	28.60
30700-1167	31389-1167	POLARIZATION OPTION #1	16	25.61	17.78	9.81	17.79	GRAY	32.0	10.04	26.06
30700-1168	31389-1168	POLARIZATION OPTION #2	16	25.61	17.78	12.81	17.79	BLACK	32.0	13.04	26.06
30700-1169	31389-1169	POLARIZATION OPTION #3	16	25.61	17.78	15.81	17.79	NATURAL (CREAM)	32.0	16.04	26.06
30700-1147	31389-1147	POLARIZATION OPTION #1	14	23.07	15.24	8.54	17.79	GRAY	30.0	8.77	23.52
30700-1148	31389-1148	POLARIZATION OPTION #2	14	23.07	15.24	11.54	17.79	BLACK	30.0	11.77	23.52
30700-1149	31389-1149	POLARIZATION OPTION #3	14	23.07	15.24	14.54	17.79	NATURAL (CREAM)	30.0	14.77	23.52
30700-1120	31389-1120	POLARIZATION OPTION #1	12	20.53	12.70	7.25	17.98	GRAY	27.5	7.50	20.98
30700-1121	31389-1121	POLARIZATION OPTION #2	12	20.53	12.70	10.27	17.98	BLACK	27.5	10.50	20.98
30700-1122	31389-1122	POLARIZATION OPTION #3	12	20.53	12.70	13.27	17.98	NATURAL (CREAM)	27.5	13.50	20.98
30700-1100	31389-1100	POLARIZATION OPTION #1	10	17.99	10.16	6.00	17.98	GRAY	26.4	6.23	18.44
30700-1101	31389-1101	POLARIZATION OPTION #2	10	17.99	10.16	9.00	17.98	BLACK	26.4	9.23	18.44
30700-1102	31389-1102	POLARIZATION OPTION #3	10	17.99	10.16	12.00	17.98	NATURAL (CREAM)	26.4	12.23	18.44
30700-1080	31389-1080	POLARIZATION OPTION #1	8	15.45	7.62	4.73	17.98	GRAY	25.5	4.96	15.90
30700-1081	31389-1081	POLARIZATION OPTION #2	8	15.45	7.62	7.73	17.98	BLACK	25.5	7.96	15.90
30700-1082	31389-1082	POLARIZATION OPTION #3	8	15.45	7.62	10.73	17.98	NATURAL (CREAM)	25.5	10.96	15.90
30700-1060	31389-1060	POLARIZATION OPTION #1	6	15.44	5.08	3.46	17.98	GRAY	25.5	3.69	13.36
30700-1061	31389-1061	POLARIZATION OPTION #2	6	15.44	5.08	6.46	17.98	BLACK	25.5	6.69	13.36
30700-1062	31389-1062	POLARIZATION OPTION #3	6	15.44	5.08	9.46	17.98	NATURAL (CREAM)	25.5	9.69	13.36

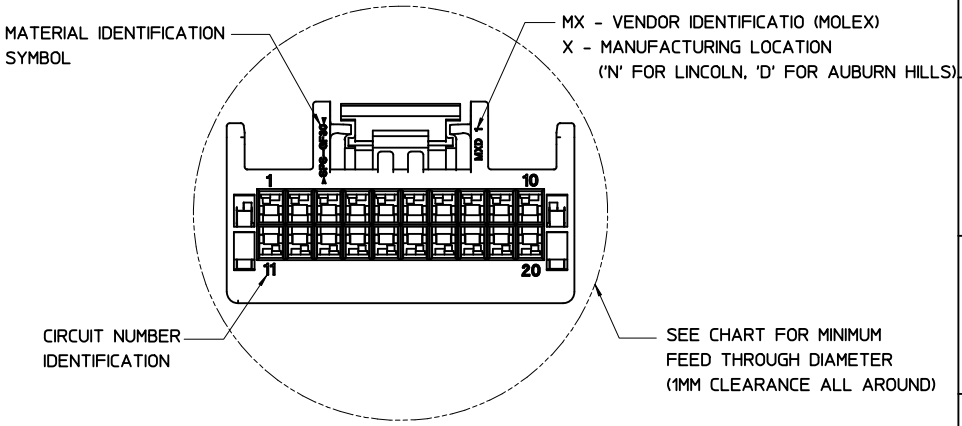
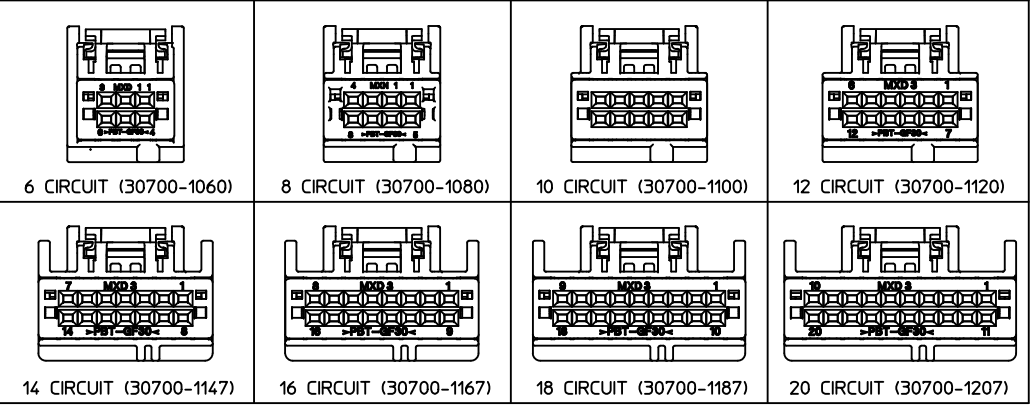
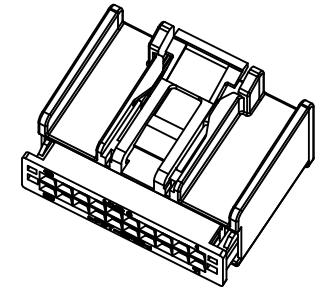

EC NO: UAU2010-1798 DRWN: DANIELE 2010/06/04 CHKD: KRISHNA 01/03/27 APPR: SMARCEAL2010/06/16	QUALITY SYMBOLS ▽ - 0 ◁ - 0	GENERAL TOLERANCES (UNLESS SPECIFIED)		SCALE 2:1	DESIGN UNITS METRIC	THIRD ANGLE PROJECTION	REVISE ON CAD ONLY	
		mm	INCH	DIMENSION STYLE MM ONLY		TITLE		
		4 PLACES ± ---	± ---	DRAWN BY R CARLSON		DATE 01/03/23		
		3 PLACES ± ---	± ---	CHECKED BY CKRISHNA		DATE 01/03/27		
2 PLACES ± 0.13	± ---	APPROVED BY LGIEIB		DATE 01/03/28		MOLEX INCORPORATED MATERIAL NO. SEE CHART DOCUMENT NO. SD-30700-120 SHEET NO. 2 OF 3		
1 PLACE ± 0.25	± ---	DRAFT WHERE APPLICABLE MUST REMAIN WITHIN DIMENSIONS		THIS DRAWING CONTAINS INFORMATION THAT IS PROPRIETARY TO MOLEX INCORPORATED AND SHOULD NOT BE USED WITHOUT WRITTEN PERMISSION				

MATING INTERFACE DIMENSIONS (REFERENCE ONLY)

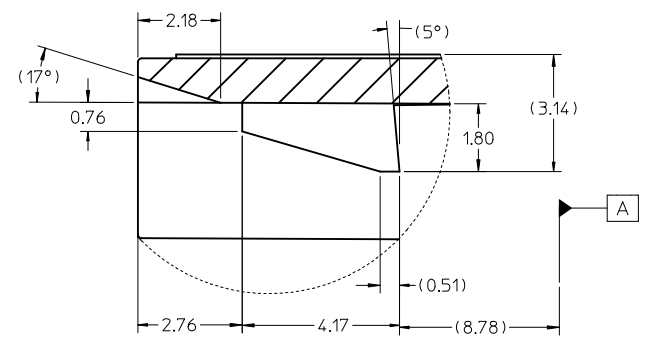
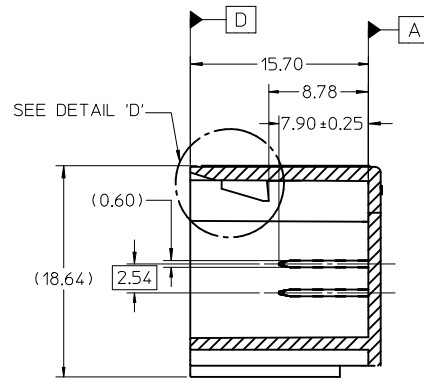
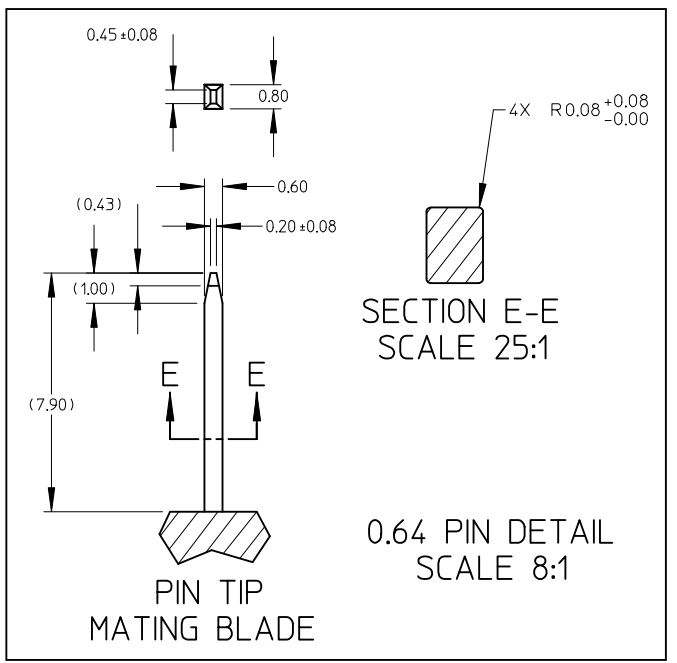
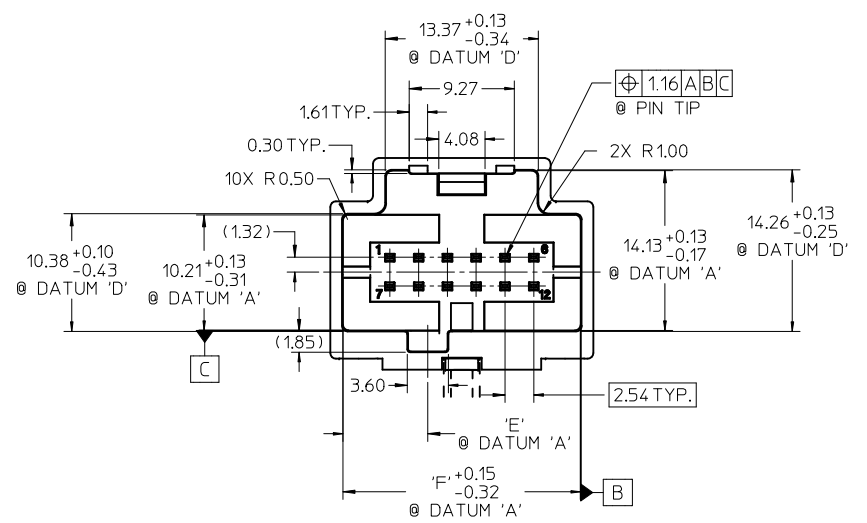
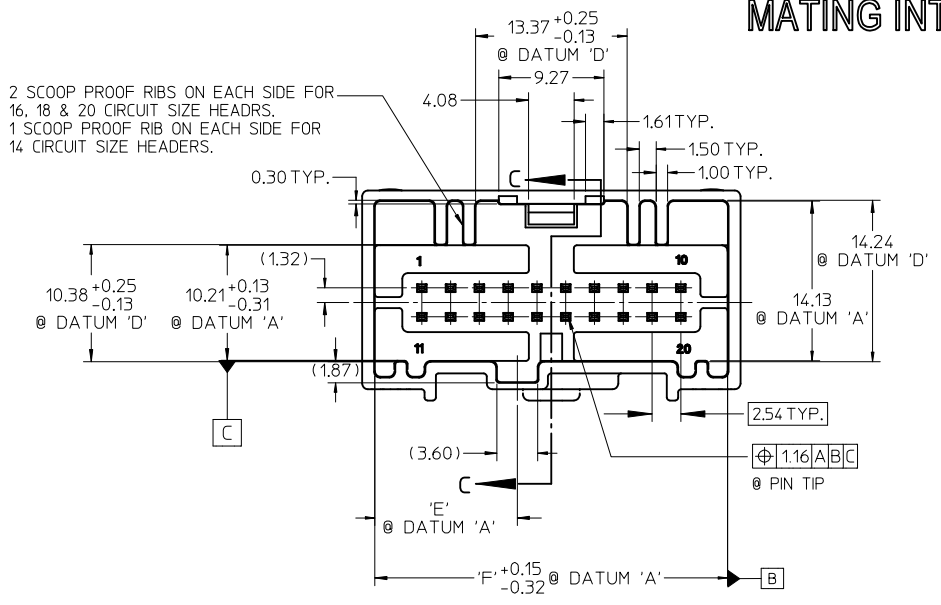

EC NO: UAU2010-1798 DRWN: VDANELE2010/06/04 CHK: SWARCEAU01/03/27 APPR: KDELA 2010/06/16	QUALITY SYMBOLS	GENERAL TOLERANCES (UNLESS SPECIFIED)	SCALE 1:1	DESIGN UNITS METRIC	THIRD ANGLE PROJECTION REVISE ON CAD ONLY	
	DESCRIPTION		m/m	INCH		DIMENSION STYLE
	REV	0	4 PLACES ± --- ± ---	MM ONLY	DRAWN BY DATE RCARLSON01/03/23	6-20 CIRCUIT HARNESS ASSEMBLY
		0	3 PLACES ± --- ± ---			
		2 PLACES ± 0.13 ± ---		CHECKED BY DATE CKRISHNA 01/03/27	APPROVED BY DATE LGIB 01/03/28	
		1 PLACE ± 0.25 ± ---			MATERIAL NO. DOCUMENT NO. SD-30700-120	
		ANGULAR ± 1/2 °			SHEET NO. 3 OF 3	
		DRAFT WHERE APPLICABLE MUST REMAIN WITHIN DIMENSIONS	THIS DRAWING CONTAINS INFORMATION THAT IS PROPRIETARY TO MOLEX INCORPORATED AND SHOULD NOT BE USED WITHOUT WRITTEN PERMISSION			