

TPD1045F

Low-Side Power Switch for Motor, Solenoid and Lamp Drive

The TPD1045F is a low-side power switch.

The IC has a vertical MOSFET output which can be directly driven from a CMOS or TTL logic circuit (e.g., an MPU). The IC is equipped with intelligent self-protection functions.

Features

- A monolithic power IC with a new structure combining a control block and a vertical power MOSFET (L²-π-MOSV) on single chip.
- Can directly drive a power load from a CMOS or TTL logic.
- Built-in protection circuits against overvoltage (active clamp), Over temperature (thermal shutdown), and overcurrent (switching mode).
- Low Drain-Source ON-resistance: $R_{DS(ON)} = 100\text{ m}\Omega$ (max)
 (@ $V_{IN} = 5\text{ V}$, $I_D = 2\text{ A}$, $T_{ch} = 25^\circ\text{C}$)
- 8-pin SOP package with embossed-tape packing.

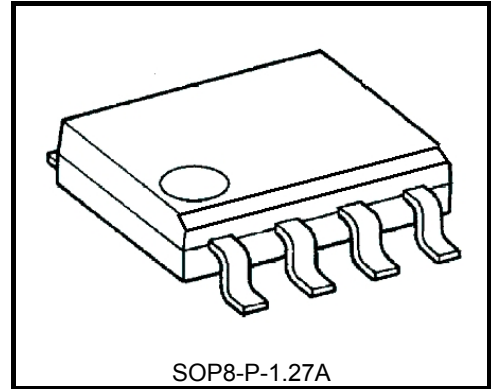

Weight: 0.08 g (typ.)

Pin Assignment (top view)

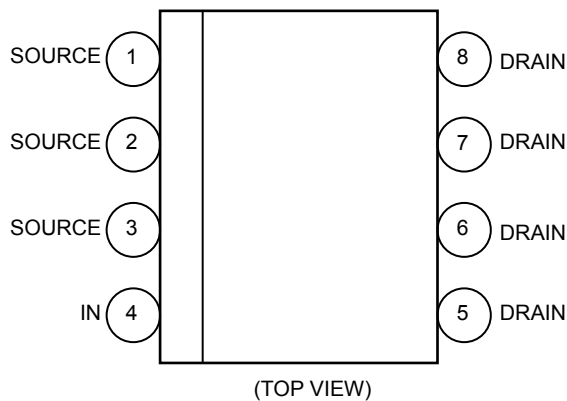

Marking

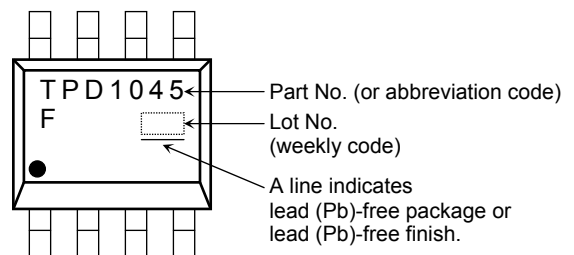

Note 1: Due to its MOS structure, this product is sensitive to static electricity.

Block Diagram

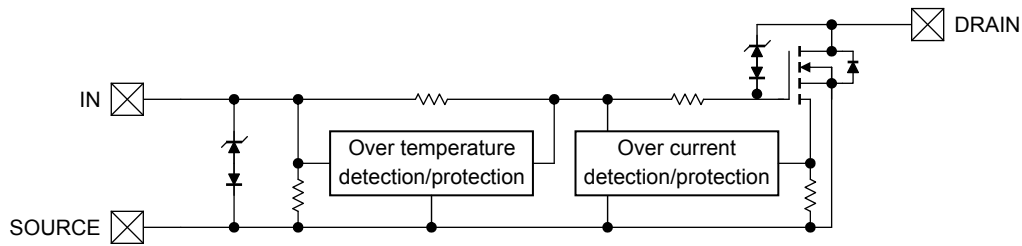

Pin Description

Pin No.	Symbol	Pin Description
1, 2, 3	SOURCE	Source (ground) pin
4	IN	Input pin. This pin is connected to a pull-down resistor internally, so that even when input wiring is open-circuited, output can never be turned on inadvertently.
5, 6, 7, 8	DRAIN	Drain pin. When the load is short circuited and current in excess of the detection current (10A min) flows to the drain (output) pin, the drain (output) automatically turns on or off.

Timing Chart

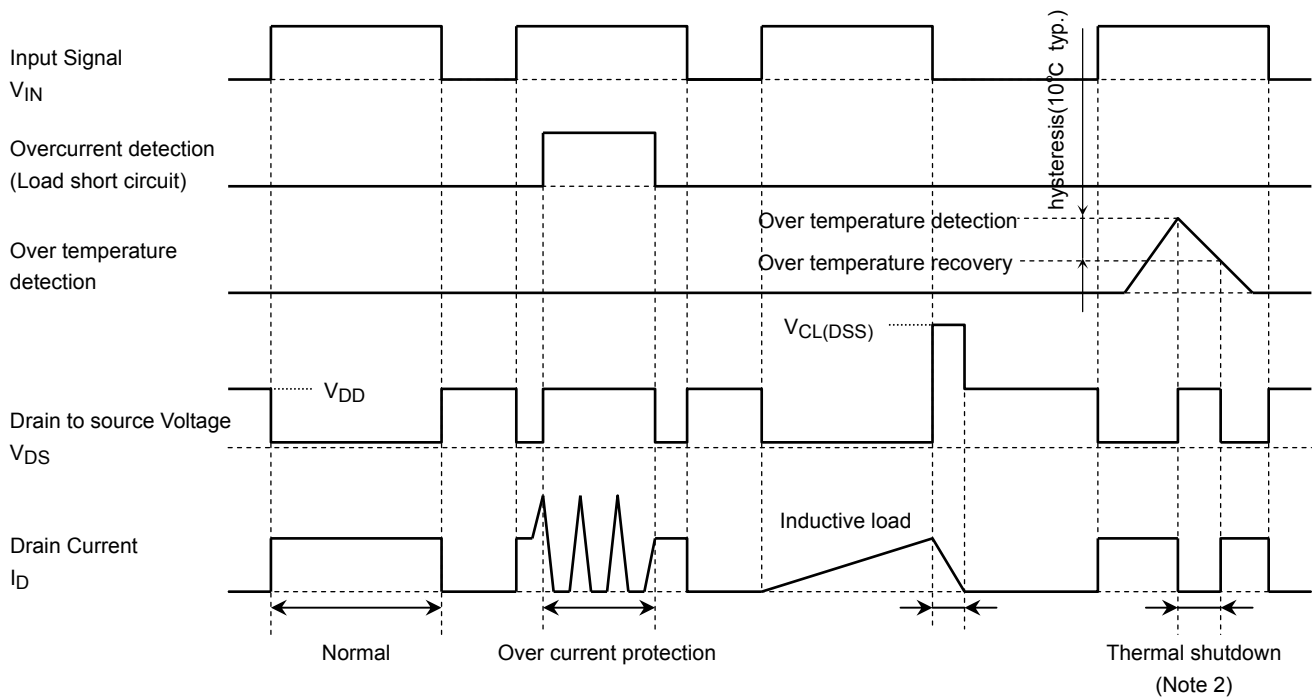

Note 2: The overheating detector circuits feature hysteresis. After overheating is detected, normal operation is restored only when the channel temperature falls by the hysteresis amount (10°C typ.) in relation to the overheating detection temperature.

Truth Table

V _{IN}	V _{DS}	Output State	State
L	H	OFF	Normal
H	L	ON	
L	H	OFF	Overcurrent
H	H	current limiting (switching)	
L	H	OFF	Overtemperature
H	H	ON	

Absolute Maximum Ratings (Ta = 25°C)

Characteristics	Symbol	Rating	Unit
Drain-source voltage	V _{DS} (DC)	50	V
Drain current	I _D (DC)	Internally Limited	A
Input voltage	V _{IN}	-0.3~7	V
Power dissipation(Note 3-a)	P _D (1)	1.1	W
Power dissipation(Note 3-b)	P _D (2)	0.425	W
Single Pulse Active Clamp Tolerance (Note 4)	E _{AS}	158	mJ
Active Clamp Current	I _{AR}	5	A
Repetitive Active Clamp Tolerance (Note 3-a) (Note 5)	E _{AR}	0.11	mJ
Operating temperature	T _{opr}	-40~125	°C
Channel temperature	T _{ch}	150	°C
Storage temperature	T _{stg}	-55~150	°C

Note: Using continuously under heavy loads (e.g. the application of high temperature/current/voltage and the significant change in temperature, etc.) may cause this product to decrease in the reliability significantly even if the operating conditions (i.e. operating temperature/current/voltage, etc.) are within the absolute maximum ratings and the operating ranges.

Please design the appropriate reliability upon reviewing the Toshiba Semiconductor Reliability Handbook ("Handling Precautions"/Derating Concept and Methods) and individual reliability data (i.e. reliability test report and estimated failure rate, etc).

Thermal Characteristics

Characteristics	Symbol	max	Unit
Thermal resistance, channel to ambient	R _{th(ch-a)}	113.5 (Note 3-a)	°C /W
		294.0 (Note 3-b)	

Note 3: 3-a : glass epoxy board (a)

3-b : glass epoxy board (b)

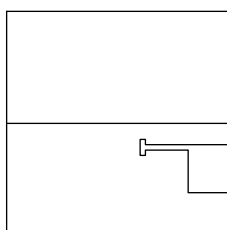

FR-4
25.4 × 25.4 × 0.8
(unit : mm)

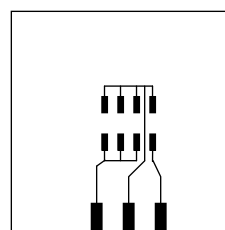

FR-4
25.4 × 25.4 × 0.8
(unit : mm)

Note 4 : V_{DD} = 25 V, T_{ch} = 25 °C (initial), L = 7.4 mH, I_{AR} = 5 A, R_G = 25 Ω

Note 5 : Repetitive rating : Pulse Width limited by maximum channel temperature.

Electrical Characteristics

Characteristics		Symbol	Test Circuit	Test Condition	Min	Typ	Max	Unit
Drain to Source clamp voltage	$V_{(CL) DSS}$	-		$T_{ch} = 25^{\circ}C$	50	58	-	V
				$T_{ch} = -40 \sim 125^{\circ}C$				
Input threshold voltage	V_{th}	-		$T_{ch} = 25^{\circ}C$	1.0	1.5	2.8	V
				$T_{ch} = -40 \sim 125^{\circ}C$				
Protective circuit operation input voltage range	$V_{IN (opr)}$	-		$T_{ch} = -40 \sim 125^{\circ}C$	4	-	7	V
Drain cut-off current	I_{DSS}	-		$T_{ch} = 25^{\circ}C$	-	-	10	μA
				$T_{ch} = -40 \sim 125^{\circ}C$				
High level input current	$I_{IH (1)}$	-		$T_{ch} = 25^{\circ}C$	-	300	750	μA
				$T_{ch} = -40 \sim 125^{\circ}C$				
High level input current	$I_{IH (2)}$	-		$T_{ch} = -40 \sim 125^{\circ}C$	-	-	1200	μA
Drain to Source on resistance	$R_{DS (ON)}$	-		$T_{ch} = 25^{\circ}C$	-	70	100	$m\Omega$
				$T_{ch} = -40 \sim 125^{\circ}C$				
Load-short tolerance	V_{DS}	-		$T_{ch} = -40 \sim 125^{\circ}C$	18	-	-	V
Over temperature detection	temperature detection	$T_{OT(1)}$	-		150	170	200	$^{\circ}C$
	temperature recovery	$T_{OT(2)}$	-					
Over current detection	I_{OC}	-		$T_{ch} = 25^{\circ}C$	5	10	-	A
				$T_{ch} = -40 \sim 125^{\circ}C$				
Switching time	t_{on}	1		$T_{ch} = 25^{\circ}C$	-	25	100	μs
				$T_{ch} = -40 \sim 125^{\circ}C$				
	$T_{ch} = 25^{\circ}C$							
	$T_{ch} = -40 \sim 125^{\circ}C$							
Drain to Source diode forward voltage	V_{DSF}	-		$T_{ch} = 25^{\circ}C$	-	-	1.8	V

Test Circuit 1

Switching time measuring circuit

Test circuit

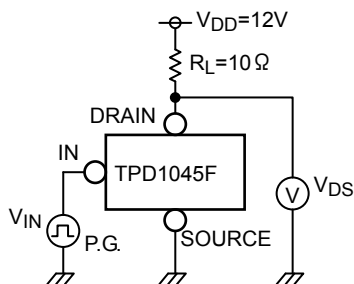

Measured waveforms

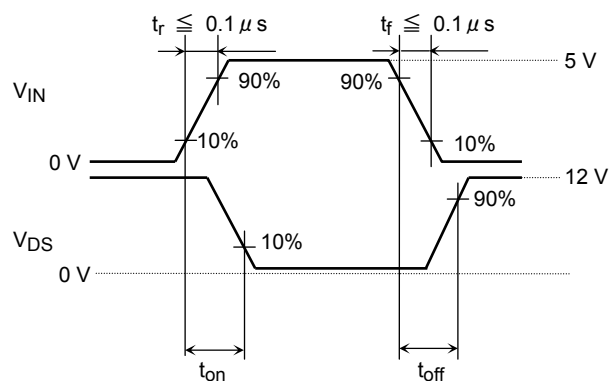

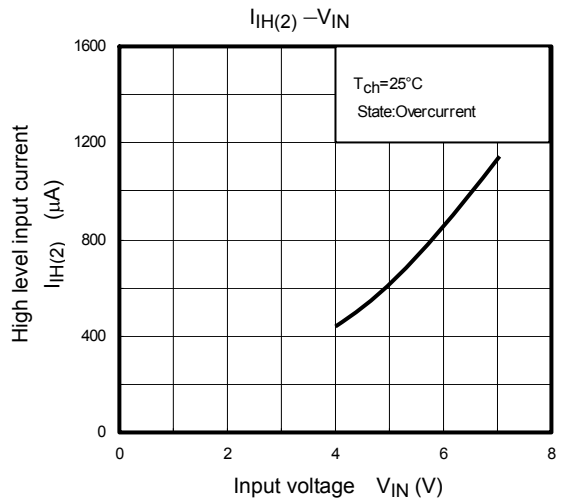
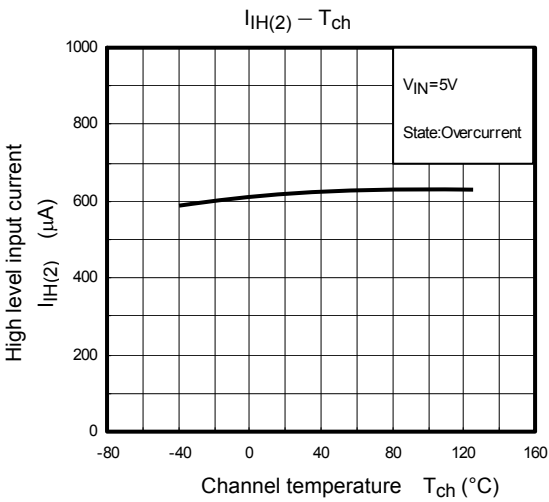
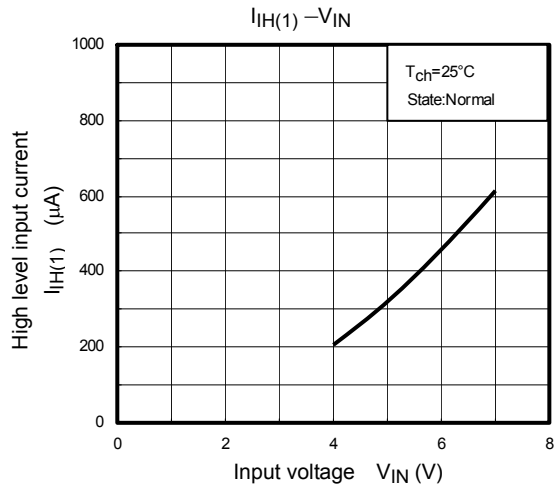
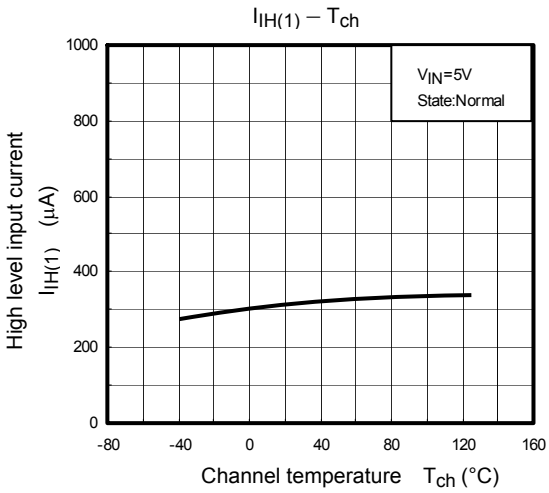
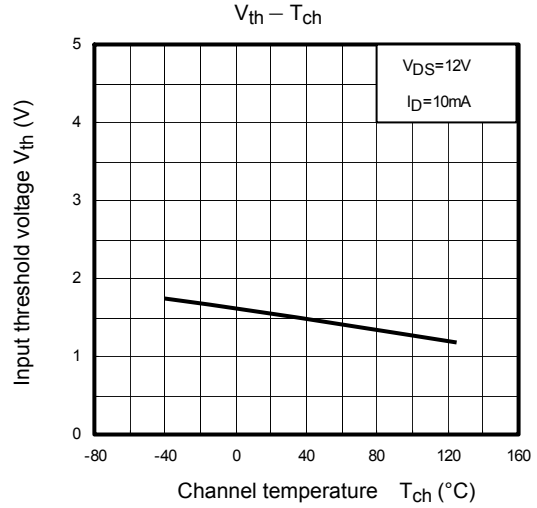
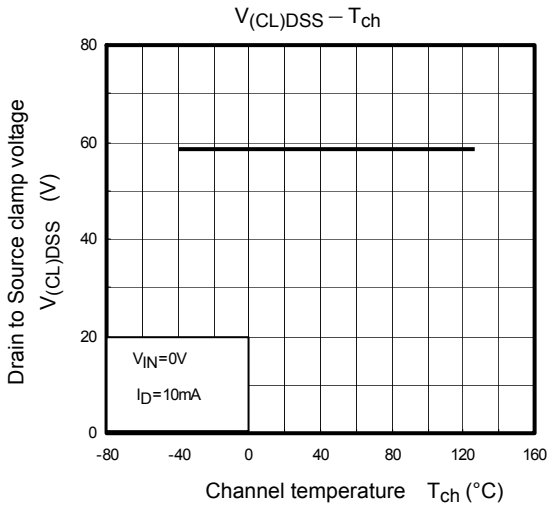

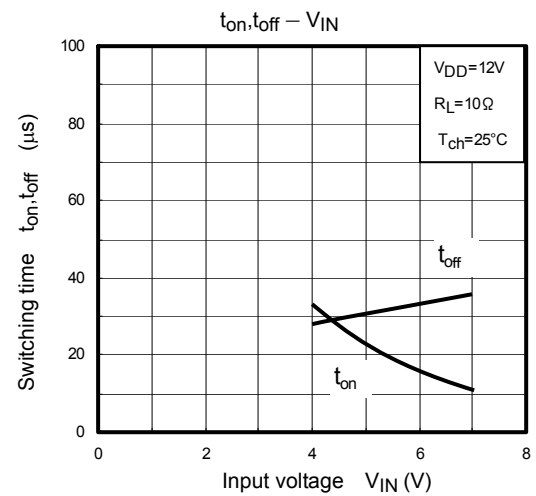
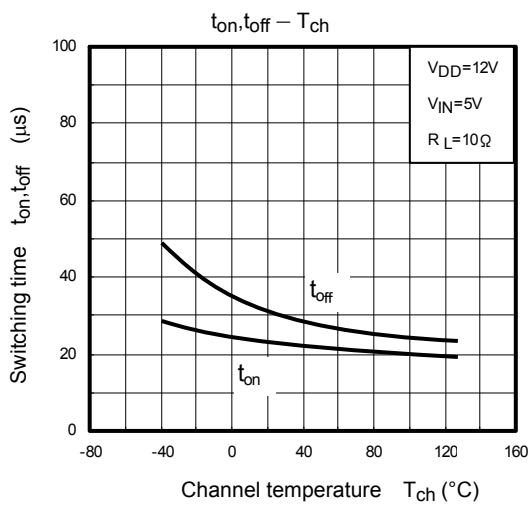
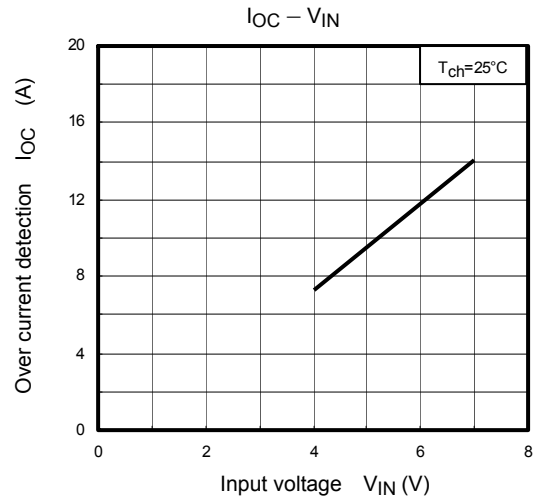
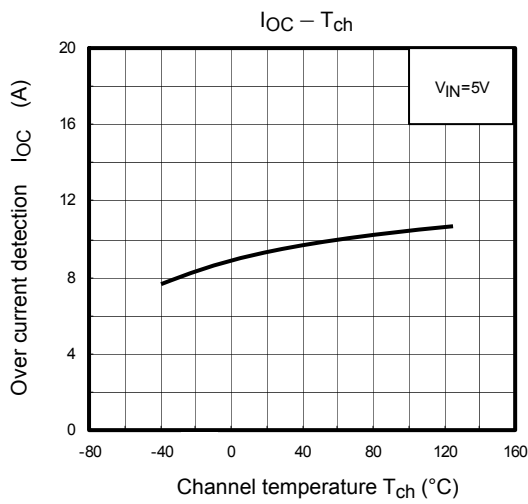
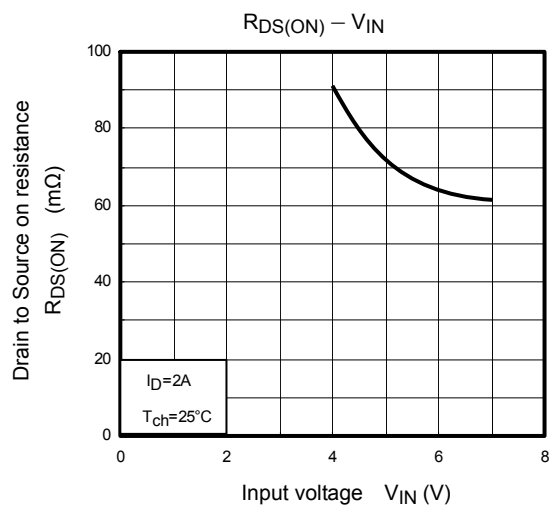
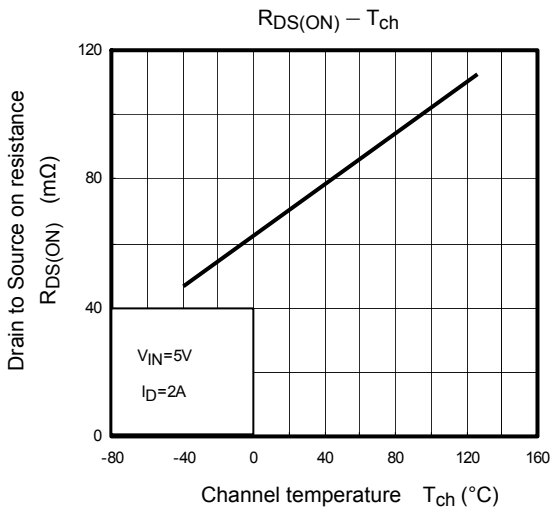

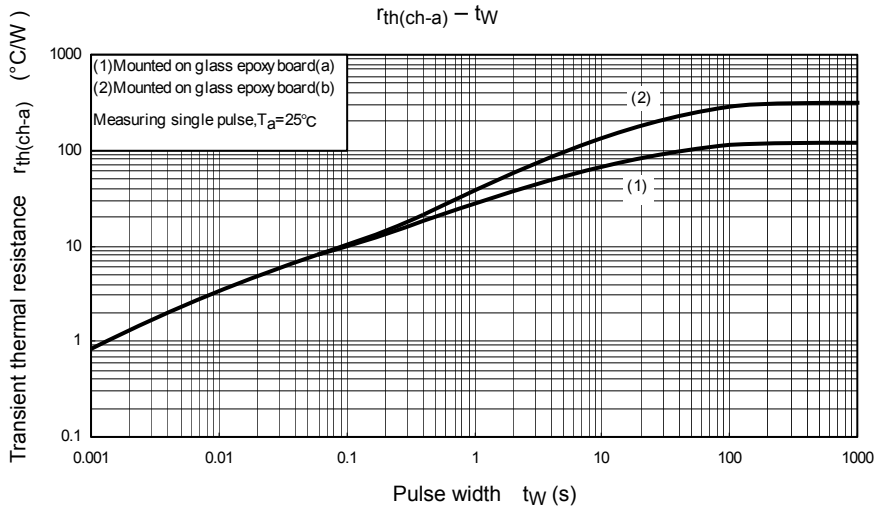
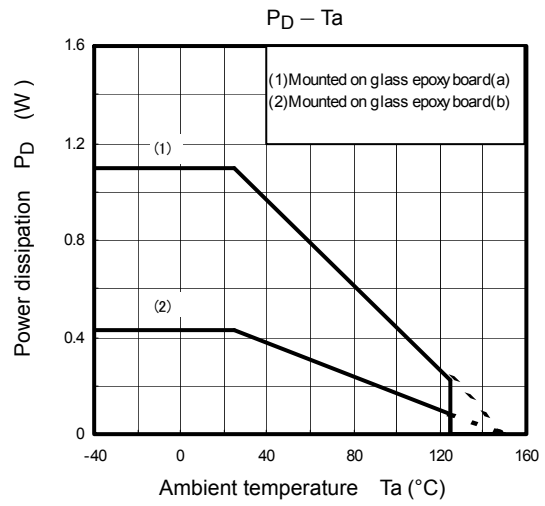
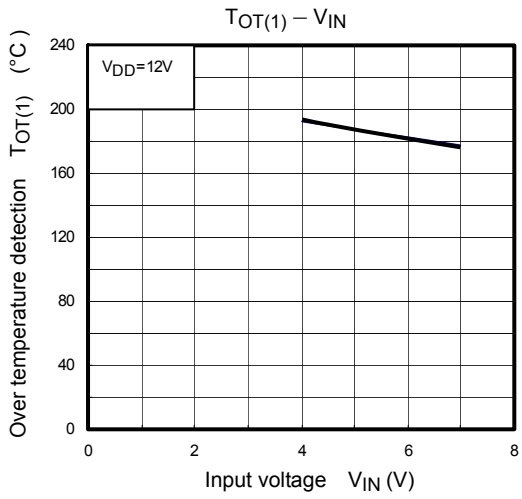

Package Dimensions

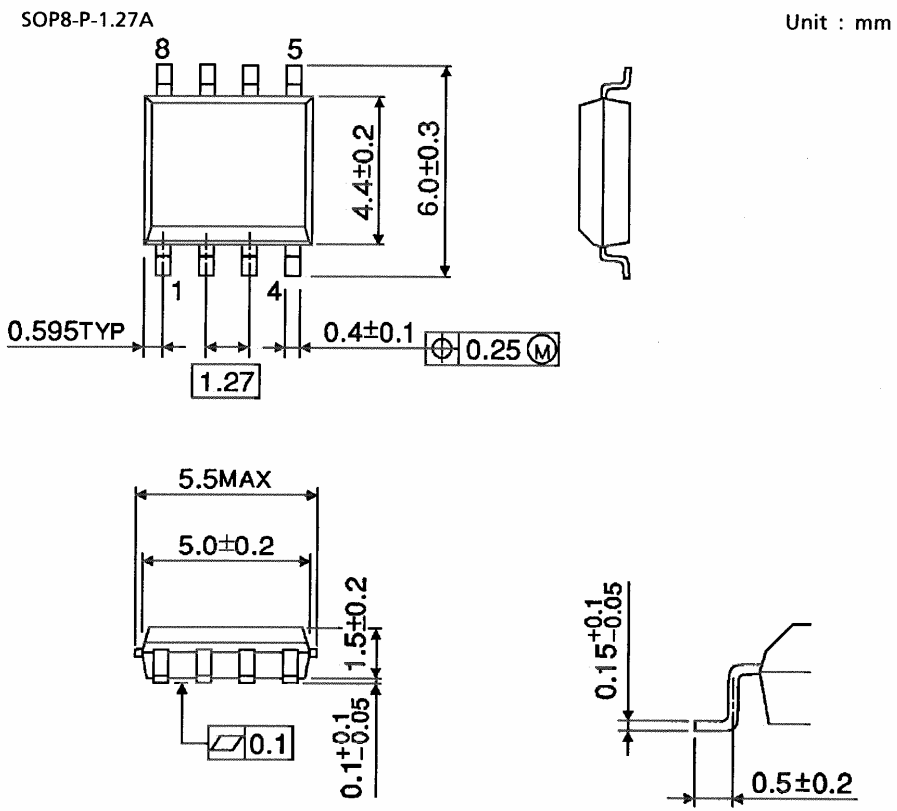

Weight: 0.08 g (typ.)

RESTRICTIONS ON PRODUCT USE

20070701-EN

- The information contained herein is subject to change without notice.
- TOSHIBA is continually working to improve the quality and reliability of its products. Nevertheless, semiconductor devices in general can malfunction or fail due to their inherent electrical sensitivity and vulnerability to physical stress. It is the responsibility of the buyer, when utilizing TOSHIBA products, to comply with the standards of safety in making a safe design for the entire system, and to avoid situations in which a malfunction or failure of such TOSHIBA products could cause loss of human life, bodily injury or damage to property.
In developing your designs, please ensure that TOSHIBA products are used within specified operating ranges as set forth in the most recent TOSHIBA products specifications. Also, please keep in mind the precautions and conditions set forth in the "Handling Guide for Semiconductor Devices," or "TOSHIBA Semiconductor Reliability Handbook" etc.
- The TOSHIBA products listed in this document are intended for usage in general electronics applications (computer, personal equipment, office equipment, measuring equipment, industrial robotics, domestic appliances, etc.). These TOSHIBA products are neither intended nor warranted for usage in equipment that requires extraordinarily high quality and/or reliability or a malfunction or failure of which may cause loss of human life or bodily injury ("Unintended Usage"). Unintended Usage include atomic energy control instruments, airplane or spaceship instruments, transportation instruments, traffic signal instruments, combustion control instruments, medical instruments, all types of safety devices, etc.. Unintended Usage of TOSHIBA products listed in this document shall be made at the customer's own risk.
- The products described in this document shall not be used or embedded to any downstream products of which manufacture, use and/or sale are prohibited under any applicable laws and regulations.
- The information contained herein is presented only as a guide for the applications of our products. No responsibility is assumed by TOSHIBA for any infringements of patents or other rights of the third parties which may result from its use. No license is granted by implication or otherwise under any patents or other rights of TOSHIBA or the third parties.
- Please contact your sales representative for product-by-product details in this document regarding RoHS compatibility. Please use these products in this document in compliance with all applicable laws and regulations that regulate the inclusion or use of controlled substances. Toshiba assumes no liability for damage or losses occurring as a result of noncompliance with applicable laws and regulations.